

MJK North America Inc.
37 Sherwood Terrace, #126
Lake Bluff, IL 60044
Tel.: 847-482-8655
877-MJK-LINK
Fax: 847-482-8654
mjkusa@mjk.com
www.mjk.com



Shuttle®

Ultrasonic Level Transmitter and Sensor



User Manual



New
All MJK's newest ultrasonic sensors covered and described in this manual

New setup procedure. See page 14 for choosing correct sensor type at initial setup.

IMPORTANT

The first time power is applied to the mounted Shuttle® level transmitter and ultrasonic sensor, the level transmitter must be configured for the connected sensor type.

The procedure is located on page 14, "Applying power".

If, at a later time, another or a newer sensor type is connected to the transmitter, the level transmitter must be re-configured accordingly.

The procedure is located on page 69, "Appendix F New sensor / changing sensor".

June 2007

UL

This product is UL-CUL listed, file # E 194021.

CE certificate of conformity

This product complies with the requirements concerning electromagnetic compatibility (EMC) stipulated in Council directive no. 89/336/EEC of 3rd May 1989, altered at directive no. 92/31/EEC, on the approximation of the laws of the Member States relating to electromagnetic compatibility.

CE approvals

We declare that the Shuttle® transmitter and ultrasonic sensors comply with the values stipulated in EN 50081-1 and EN 50082-1.

Ex approval of ultrasonic sensors

Shuttle® ultrasonic sensors are approved for mounting in explosive atmospheres.

Types 200630/31/40/41: FM Class 1, Div. 1, Group A-G

Table of Contents

Introduction	5	Basic settings	16
About this manual	5	Units of measurement	17
Main sections	5	Sensor and zero point distance	18
Illustrations	5	Level read-out	19
Safety instructions	6	The well is not empty	19
Repair	6	mA output	20
Ex equipment	6	Relay outputs	21
Product identification	6	Selection of relay 1 and 2	21
Mounting	7	Pump control with relay 1 and 2	22
General	7	Level control with relay 1	23
Explosion hazardous areas	7	System alarm on relay 1	24
Mechanical mounting	7	Selection of relay function for relay 2	25
Level transmitter	7	Level control with relay 2	26
Ultrasonic sensor	8	System alarm on relay 2	27
Electrical mounting	9	Start of the learning function	28
Level transmitter	9	First time activation	28
Ultrasonic sensor	10	Activating the learning function	29
Cutting the cable	10	Activation / deactivation	29
Display and keyboard	11	Settings	30
General	11	User settings	30
The display symbols	12	User and factory settings	30
Displayed during programming	12	Factory settings	30
Displayed during normal service	12	Possible settings	31
The keyboard	13	Trouble shooting	32
Basic settings	13	General	32
Special settings	13	Indications on system errors	32
Get started	14	Normal read-out	32
Applying power to Shuttle®	14	Too weak or missing echo	32
Sensor type selection	14	System (sensor) error	32
- the well is empty	15	Temperature error	32
- the well is not empty	15	Internal stack error	32
		EE-PROM error	33
		Power failure	33
		Trouble shooting table	33
		Ex Instructions	35

A	Technical specifications	37	E	Special menus.....	46
	Dimensions	37		Bar graph read-out.....	47
	Shuttle® Ultrasonic Sensors	38		Active measuring range	48
	Standard Range Version	38		Response time	49
	Standard Range Version/FM Approved.....	39		Measuring method (application)	50
	Extended Range Version	40		mA output signal during system error ..	51
	Chemical Resistant Version	41		Calibration of the level measurement ..	52
B	Changing supply voltage	42		Offset level readout.....	53
	Conversion from 115 to 230 V AC	42		Indication of echo quality	54
	Conversion from 230 to 115 V AC	42		Indication of signal amplification.....	55
C	Sensor mounting considerations	43		Indication of time period without echo ..	56
	General	43		Select factory settings	57
	The spread of the ultrasonic signal	43		Access code	58
	Measurements.....	44		Readout of version numbers.....	59
	Along a wall / other surface	44		Find zero level at next power-up	60
	Through a concrete deck.....	44		Fixed mA signal	61
	In a tank / container.....	44		Investigative measurement intervals.....	62
	Through pipe for foam protection	44		System alarm delay	63
D	Service menu	45		Averaging the level measurement	64
				Max. amplification level	65
				Min. level for accept of ultrasonic echo ..	66
				Sensitivity of the learning function	67
				Changing the access code.....	68
			F	New sensor / changing sensor ..	69
				Open the choose sensor menu.....	69

Introduction

Thank you for choosing the MJK Shuttle® Ultrasonic Level Transmitter.

We have done everything possible to make a level transmitter that can fulfill all your demands.

Shuttle® is suitable for all kinds of level measurements with ultrasound and can control and supervise levels in wells and tanks - including aggressive and polluted media.

The level meter is both easy to install and put into service, but read this manual first - then you will get the most benefits from the Shuttle® Ultrasonic Level Transmitter right from the beginning.

You can always contact your representative or the MJK Service Hotline for advice and guidance. Also, take a look at <http://www.mjk.com>.

Shuttle® is registered trademark of MJK.

About this manual

Main sections

This manual is divided into the following three main sections:

- 1: Introduction
presentation of the Shuttle® and this manual
- 2: Mounting
information for performing mechanical and electrical mounting.
- 3: Basic settings
a look through the most common settings

Illustrations

All the Shuttle® display read-outs are illustrated in this manual. Some of the display segments will flash, and in this manual the display read-outs with flashing segments are coloured white and the fixed segments are coloured black.

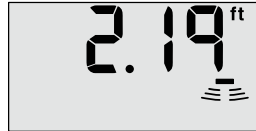

Example: Normal display read-out - none of the segments are flashing.



Example: Missing echo - the bar on the right hand side is flashing.

Section "Display" gives a more detailed description of the display symbols shown during programming and during normal service. Furthermore, the menu explanations show all the display indications belonging to the specific menu during programming of the Shuttle® Ultrasonic Level Transmitter.

Safety instructions

- 1: Read this manual carefully.
- 2: Be aware of the environment at the installation site. Wear necessary protective equipment and follow all current safety regulations.
- 3: Shuttle® can provide a start signal for dangerous machinery. Always ensure that connected machinery and other equipment **are effectively being put out of service** (i.e. removal of main fuses, lock main- and/or security switches in off position) before commencing setting, fault finding, service and maintenance work etc.
- 4: There is a risk of lethal electrical shock from terminal 1 to 5 and L-N. Be careful not to touch these while Shuttle® is in service.

Repair

- 1: Repair of Ex approved equipment (ultrasonic transmitter) must only be made by MJK or by a service representative approved by MJK.

Ex equipment

- 1: All current local and national standards, regulations regarding installation and use of Ex approved equipment, certifications and safety instructions for Ex equipment, that have been used together with the installation of Shuttle® must be strictly observed.

Product identification

Check that the item(s) delivered corresponds to the ordered item(s). The item number is printed on a label that is stuck onto the packing. Shown below is the label for a delivery including a level transmitter and an ultrasonic sensor:



- ① Item number ③ Serial number
- ② Item description

An identical marking can be found on the right hand side of the level transmitter cabinet:



Mounting

General

Shuttle® measures the level by sending an ultrasonic signal against the surface and measuring the delay time of the received echo.

Although Shuttle® is equipped with a very advanced system for eliminating measuring errors, the ultrasonic sensor must - as much as possible - be mounted so that the ultrasonic signal is not disturbed by liquid being pumped in or by mixers, ladders or other installations in the tank.

The liquid surface should also be calm and without waves and possibly without foam that may muffle the ultrasonic echo too much.

Since the ultrasonic beam is extremely narrow (3° - 7° depending on the type of sensor), Shuttle® can be used for measurements in very narrow tanks or wells. This requires that the ultrasonic sensor is mounted so it points **absolutely vertical** against the surface - or the ultrasonic echo will simply miss the sensor.

Explosion hazardous areas

The ultrasonic sensor is Ex approved in accordance with EN 50021:1999 and can be mounted in Zone 2 without the need of a zener barrier. Please check local requirements before installing in hazardous locations.

The level transmitter (= the electronic box with display) must not be mounted in explosive hazardous areas.

Mechanical mounting

Level transmitter

Shuttle® is in NEMA 4X enclosure and can be mounted outdoors directly on a wall, a railing or a banister with mounting plate 200240 and universal bracket 200205.

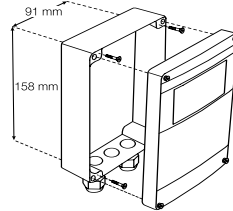

Shuttle® Ultrasonic Level Transmitter mounted directly on a wall.

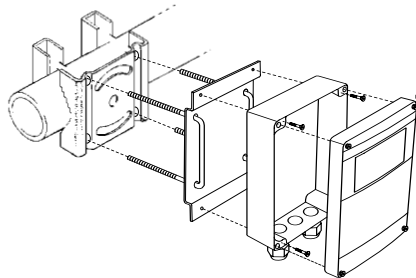

Shuttle® Level Transmitter mounted on the plant with mounting plate 200240 and universal bracket 200205.

Shuttle® must be mounted vertically in order to observe the NEMA4X standard.

Ultrasonic sensor

Two things are extremely important when mounting the ultrasonic sensor: (See also appendix C!)

- 1: It should be mounted securely.
 - 2: It should be mounted absolutely vertical.
- Use a spirit level in TWO directions.

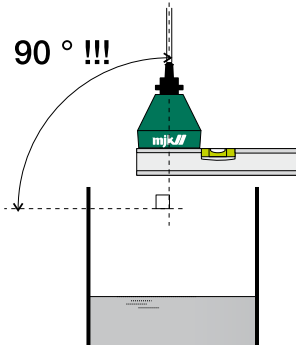

To ensure a reliable and precise level measurement it is of vital importance that the ultrasonic sensor points down absolutely vertical against the liquid surface.

The ultrasonic sensor should be mounted so the ultrasonic signal has no obstructions between sensor and surface, i.e. no pipes, cables, grates etc.



We deliver two types of sensor brackets that can be used in almost any installation. The bracket shown is a standard universal mounting bracket (200220).

The ultrasonic sensor is equipped with a nut for bracket mounting. Note the recess on the nut - it must be fitted safely in the bracket for firm fixing to the bracket:

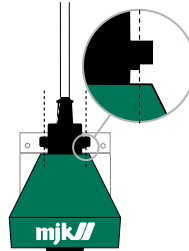

For the highest accuracy, the ultrasonic sensor should be mounted as close as possible to the highest possible level that can occur + 14 in. See below:

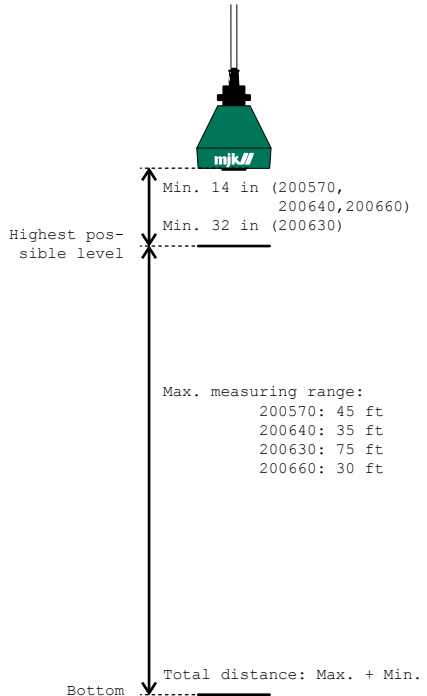

Electrical mounting

Level transmitter

The Shuttle® must not be connected to the power supply before the ultrasonic sensor is mounted and connected correctly.

When the cover has been removed, the green plastic film with the menu symbols is tipped up to gain access to the terminals.



Shuttle® can be supplied with 10 - 30 V DC on terminal 10 and 12 or with 115 / 230 V AC on terminal L and N.

Current regulations for conductor and fuse dimensions should always be observed.

Always confirm that the Shuttle® voltage rating match the present voltage.

If Shuttle® is intended for 115 V AC supply, it will be indicated with a label below the rightmost terminal block as shown here:



Shuttle® is intended for 115 V AC.



Shuttle® is intended for 230 V AC.

Mount the wires according to the terminal numbers on the back side of the green plastic film:

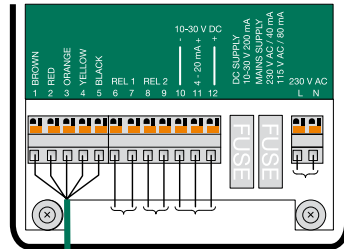

0.4 in!
(13/32")

Ensure that minimum 0.4 in insulation is removed!
Use copper wire only. (75 °C / 167 °F)

The Shuttle® is equipped with spring terminals. Tightening is not needed.

Not for connection to rigid conduit.

Terminal:	Designation:
1 - 5	Ultrasonic sensor
6 - 7	Relay output 1 (Max. 50 V, 1 A resistive load)
8 - 9	Relay output 2 (Max. 50 V, 1 A resistive load)
10 and 11	4-20 mA output (Max. 500 Ω load)
10 and 12	10 - 30 V DC supply
L	115 / 230 V AC live
N	115 / 230 V AC neutral

Ultrasonic sensor

The ultrasonic sensor is delivered as standard with 39 ft of cable. The ultrasonic sensor can be delivered with up to 300 ft of cable on order, or the standard 39 ft cable can be extended to max. 300 ft.

The cable is a special low capacity cable, so extensions should always be made with the same type of cable.

One of the most common faults on a Shuttle® installation is bad or faulty cable connections or using cables that do not meet the required specifications.

It is recommended to use connection box 200590 if the sensor cable must be extended.

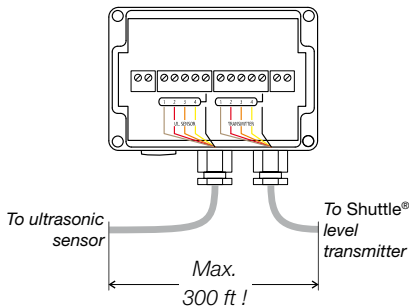

The ultrasonic sensor cable has 5 wires with both color code and number:

Number:	Color:	Designation:
1	Brown	Ultrasonic pulse
2	Red	
3	Orange	Temperature compensation
4	Yellow	
5	Black	Shield ①

① This wire is connected to the cable shield.

The wires are mounted according to the terminal markings on the connection box PCB and on the Shuttle® respectively.

Cutting the cable

The cable is delivered with the wires stripped as shown with the black wire (no. 5) soldered to the shield:



When the cable is cut, only 4 wires will appear:



When the cable has been cut, the shield should be mounted in terminal 5 instead of the black wire !

When the ultrasonic sensor is mounted and connected correctly, the Shuttle® can be connected to the power supply.

See section 'Get started'.

Display and keyboard

General

The keyboard is used only for the initial programming of the Shuttle®, and is therefore hidden behind the front lid. The keys are marked with symbols indicating their function. The same symbols are used throughout this manual under the explanation of the individual menus.

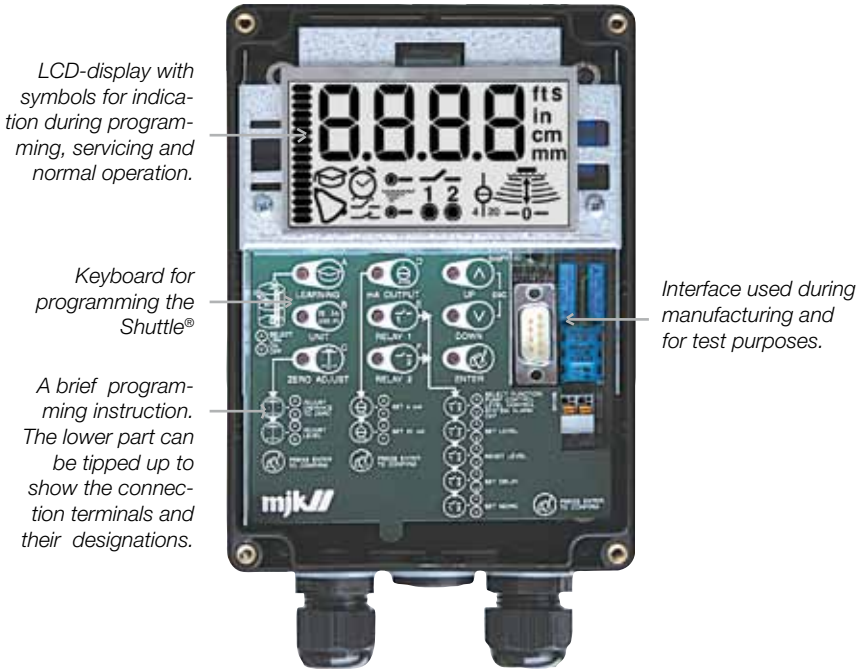

The display symbols

The different display segments indicates the actual level, the state of the output relays etc. during normal service and indicates limit values, selection of measuring unit and other settings during programming.

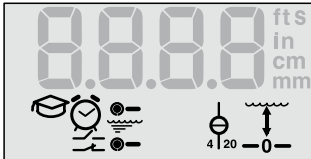

The segments shown will be lit during programming of the Shuttle®.

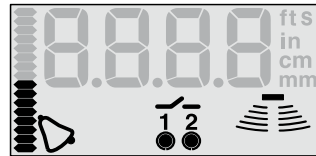

The segments shown will be lit when Shuttle® are in normal service.

Displayed during programming

8.8.8.8 Numerical read-out of limit values, delays and other numerical settings and selections. Is also used to show an initial letter code at start up of the special settings.
See also pages 46 - 69.

fts
in
cm
mm Displayed when selecting the desired measuring unit (see page 17) and when selecting time delays.

Start / activation of the learning function. See also pages 28 - 29.

Flashes when setting the time delays.
See also pages 22 - 24, 26 and 27.

Displayed when programming the output relays.
See also pages 23 - 24 and 26 and 27.

Displayed when setting the start and stop levels for the output relays.
See also pages 21 - 23 and 25 - 26.

Displayed when setting the zero point and span for the mA output.
See also page 20.

Displayed when setting the distance between sensor and zero point and setting of level read-out.
See also pages 18 - 19.

Displayed during normal service

8.8.8.8 Numerical read-out of the actual level.

Bar graph for indication of the signal level on the mA-output or for indication of the actual level.

Alarm symbol. The symbol is shown if a system error should occur on the Shuttle®.
See also pages 24 and 27.

Indication of the status of the output relays and whether the output relays are in use. The round dot below the relay number will appear steady when the relay is activated and will appear flashing when the relay is about to be activated after a preset time delay.
See also pages 22 - 24, 26 and 27.

This group of symbols indicates the strength of the received ultrasonic echo. A good measuring signal is indicated by three or more sets of arches.
See also page 32.

The keyboard

From the Shuttle® keyboard the keys marked A - F (①) gives access to 21 menus divided in 6 basic settings and 15 special settings.

There is direct access to the menus for basic settings by pressing one the keys A to F.

See appendix E for instructions for access to the special settings.

When a menu has been selected, settings are made with the UP and DOWN keys and the selection is confirmed with the ENTER key (④) whereafter Shuttle® reverts to normal read-out. To leave any menu without changing the settings, press the UP and DOWN keys simultaneously (ESCape, ③).

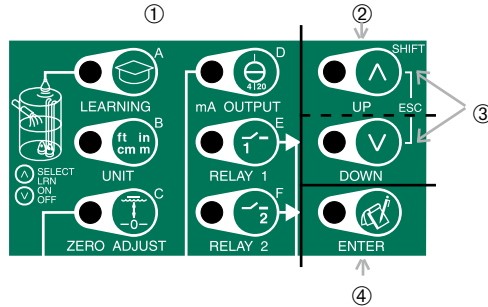

Basic settings (see pages 14 - 28)

- A (LEARNING)
Start and activation/deactivation of the learning function.
- B (UNIT)
Selection of measuring unit.
- C (ZERO ADJUST)
Setting of sensor distance and zero point.
- D (mA OUTPUT)
Setting of the mA output.
- E (RELAY 1)
Setting of the functions for relay output # 1.
- F (RELAY 2)
Setting of the functions for relay output # 2.

Special settings (see Appendix E)

- Shift + A (bA - bar graph readout)
- Shift + B (rA - Active measuring range)
- Shift + C (rE - response time for level changes)
- Shift + D (AP - Application setup)
- Shift + E (S. Err - System error indication)
- Shift + F (LE - Level readout calibration)
- Esc + A (nAP - Setting of reference level)
- Esc + B (Qu - Indication of signal quality)
- Esc + C (Sh - Indication of signal amplification)
- Esc + D (dE - Period without echo)
- Esc + E (FA - Factory settings)
- AxsC + A (S. Ln - HW/SW/Serial numbers)
- AxsC + B (S.St - Find zero level at next power-up)
- AxsC + C (12nA - Constant mA signal out)
- AxsC + D (nS - Investigative measurements interval)
- AxsC + E (S. Al - System alarm delay)

Get started

Applying power to Shuttle®

When Shuttle® is connected to power for the first time, the following texts (**Choose Sensor Press Enter**) will appear across the display:

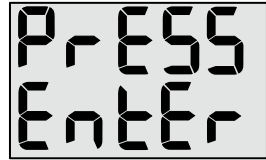
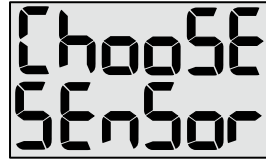

Press "Enter" once to select the required sensor type.

Sensor type selection



When "No Sensor" (**no S**) is displayed, press the 'Up' or 'Down' arrow key to leaf through the different sensor types: 2005xx and 2006xx.



When the required sensor type appears on the display (here: 200570), press "Enter" once.

The sensor type is now registered by the level transmitter, and "Press Enter" passes across the display to indicate that you may continue with setting/measuring a level of 0 meter (nil, empty tank).

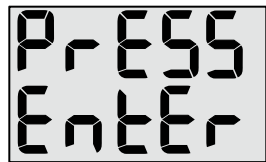

Press "Enter" once to proceed with the initial settings.

Notes:

When a sensor type has been selected, the factory settings will have no influence on this selection.

If you choose "No Sensor" (no S), the Shuttle will invoke the choose sensor menu at start-up. From this point the correct sensor type can be selected.

At the same moment Shuttle® registers an echo, the zero point is automatically set to the level that is present in the tank or well.

Furthermore, the mA output is set to 4 mA at the current zero point and 20 mA at a level corresponding to a distance of 14 in from the ultrasonic sensor.

- the well is empty...

Level read-out = distance between sensor and bottom - (minus) the distance between sensor and surface.

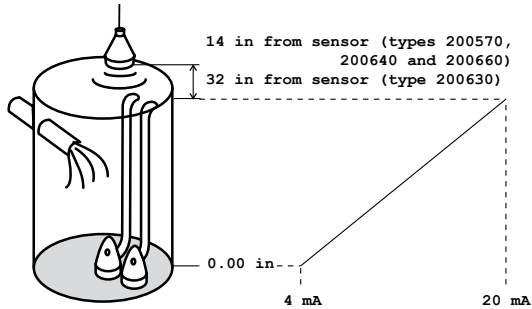

- the well is not empty...

The distance from the sensor to the zero point or the level read-out must be set manually - see page 13.

Note: The dead band varies for the different sensor types: 14 in for types 200570, 200640 and 200660, and 32 in for type 200630.

See also Appendix A, Technical Specifications beginning on page 37.

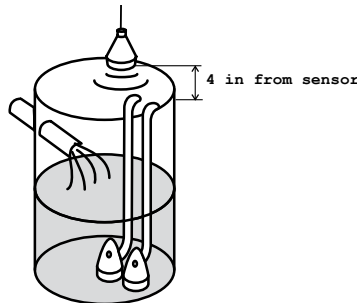

Shuttle® will now indicate the current level in the tank or well (0 ft immediately after initial startup) and is now in service as a regular level meter, i.e. without the use of the relays and the analog output for control / alarm.



See the next section for basic settings.

Basic settings

The automatic setting of the zero point and the mA output made by Shuttle® during initial startup may be adequate.

If changes of the zero point read-out and mA output setting should be necessary, and when Shuttle® is to be used as a pump controller or for level monitoring, an additional 5 settings should be made. These settings are described in detail on the following pages.

Proceed with set-up in the order listed below:

- | | |
|--|--------------------|
| 1: Setting units of measurement | See page 17. |
| 2: Setting the distance from sensor to zero point and
Setting the level read-out: | See pages 18 - 19. |
| 3: Setting the mA output: | See page 20. |
| 4: Setting the relay limits: | See page 21. |
| 5: Start of the learning function: | See pages 28 - 29. |

When the settings are made, Shuttle® is ready to be put into service.

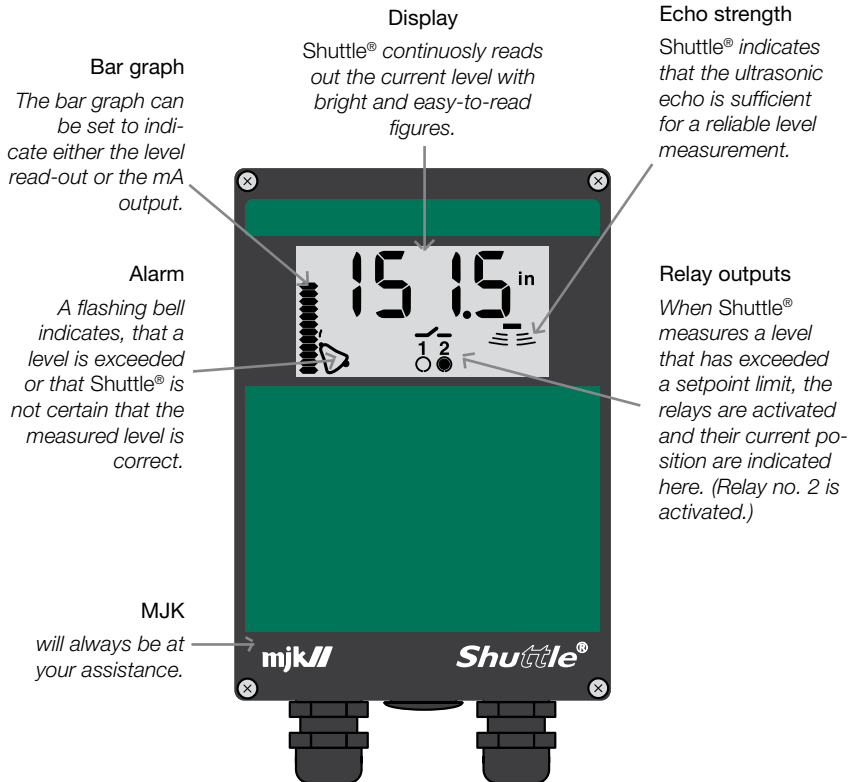

Units of measurement

If the measuring unit is changed, all other values in menus and settings will automatically be converted to the new measuring unit.

In this example the measuring unit is changed from feet to inches.

The settings will be rounded off automatically.

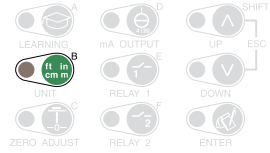

ft
in
cm
mm

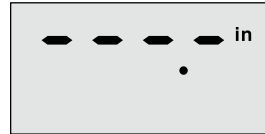

Select unit with the arrow keys.

The dot indicates the position of the decimal separator.

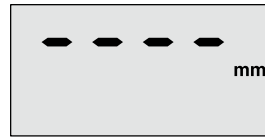
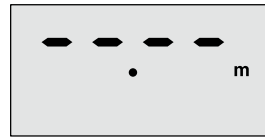
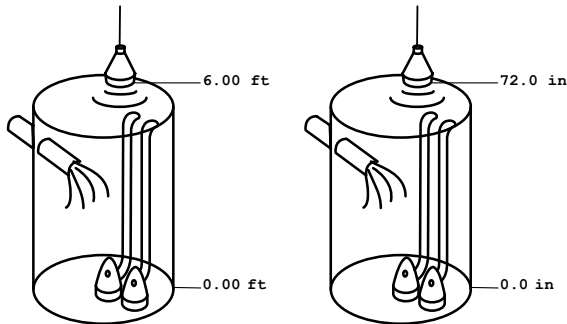
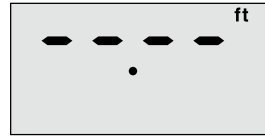

Note: 'mm' or 'in' cannot be selected if it could cause overrun in the display read-out.

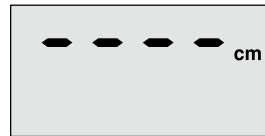

Shuttle® reverts to normal read-out with the new measuring unit.





Sensor and zero point distance

The level read-out (zero point) can be adjusted as required. This is almost always required if the well was not empty during initial startup.

Note: *The learning function settings will be erased and the relays will be deactivated if the zero point setting is changed.*

In this example, the level read-out is changed to be 1.50 ft from the bottom of the well / tank.

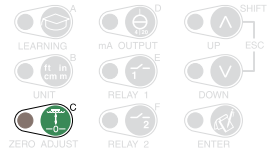

Set the new zero point with the arrow keys.

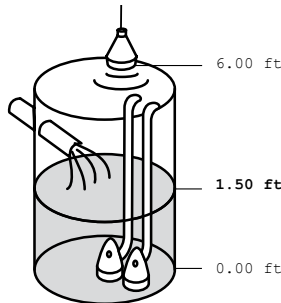

If the learning function has been activated, Shuttle® will deactivate the learning function and erase the suspicious levels that were found last time the learning function was activated.

The learning function must therefore both be started and reactivated again.

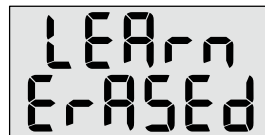

If the relay outputs are configured for pump control, the relays will be deactivated, but their limit settings will not be erased. Also, delay settings and other settings will not be erased.



Shuttle® will now read out - 1.50 ft when the well is empty.

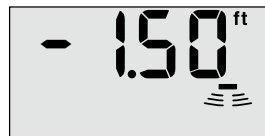

Level read-out

The well is not empty

With this function the level read-out can be increased or decreased on demand. This is almost always required if the well was not empty during initial startup.

Note: *The learning function settings will be erased and the relays will be deactivated if the zero point setting is changed.*

In this example, the actual level is 2.4 ft, but Shuttle® reads out 0 ft.

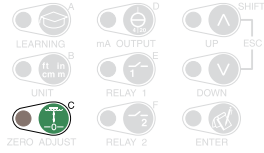

Select the desired level read-out with the arrow keys.

Shuttle® will now read out 0.00 ft when the well is empty.

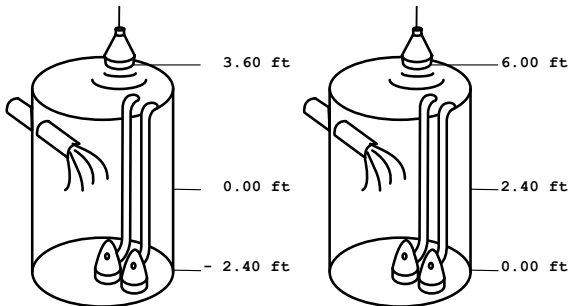

If the learning function has been activated, Shuttle® will deactivate the learning function and erase the suspicious levels that were found last time the learning function was activated.

If the relay outputs are configured for pump control, the relays will be deactivated, but their limit settings will not be erased.

Also, delay settings and other settings will not be erased.

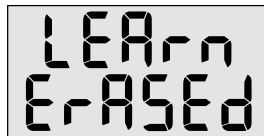

Shuttle® will now revert to normal level read-out with a increased read-out value.

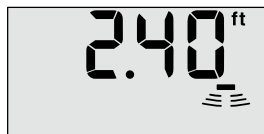



mA output

When Shuttle® is connected to the power supply for the first time, the mA-output is automatically set to provide 4 mA at zero level and 20 mA at a level corresponding to 14 in below the ultrasonic transmitter.

In this example the range of the mA output is changed from 0 - 4.95 ft to 1.5 - 4.5 ft. Changes made will not affect the relay settings.

Note: Both values can be set over the whole range thus making it possible to decrease the mA signal at rising levels and vice versa.

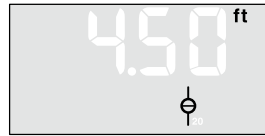
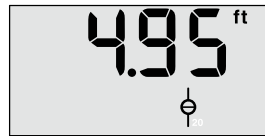
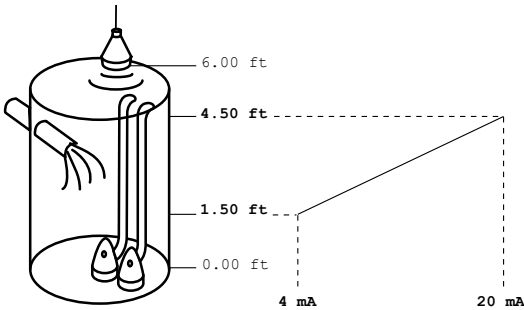
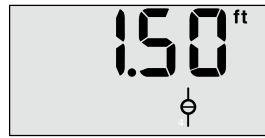
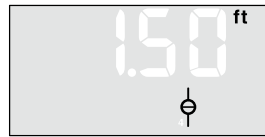
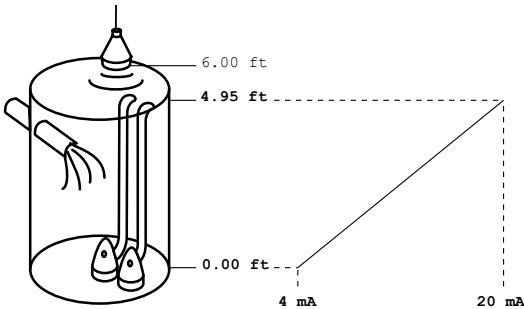
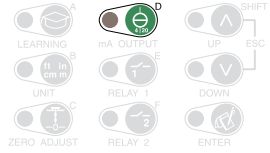

Shuttle® reverts to normal read-out.



Relay outputs

Selection of relay 1 and 2

Three functions are available:

- pump control with alternation of two pumps
- level control
- system alarm

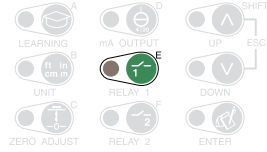

Note: If Pump Control is selected, the start and stop settings cannot be set any closer than 4 in.
If Level Control is selected, the start and stop settings cannot be set any closer than 1/2 in.



Select the desired function with the arrow keys.

Pump control:
Continue on the facing page.

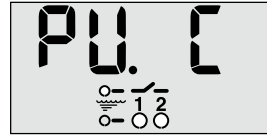

Note: If pump control is selected, both relays are set in this menu and relay 2 will not be available for other functions.
The relays can control both pumping in and pumping out, but both relays will have the same function. The function is selected automatically when relay 1 is set according to the start and stop levels. If the start level is set higher than the stop level, both relays will then be configured for pumping in. On the other hand, if the start level is set lower than the stop level, both relays will be configured for pumping in.
If it is later desired to change the setting, simply change the setting for relay 1 after which the start and stop setting for relay 2 will be switched automatically.
If the relays are configured for pump control, they will always be deactivated on system errors after 30 seconds independent of the selected time delay to prevent dry run of the pumps.

Level control:
See page 23.



System alarm:
See page 24.

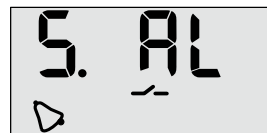
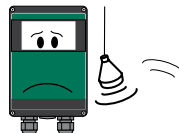



Pump control with relay 1 and 2

Start and stop level for pump no. 1 is set to 3.00 and 2.25 ft respectively.

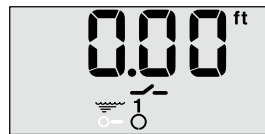
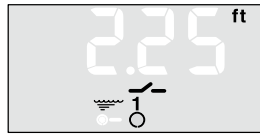
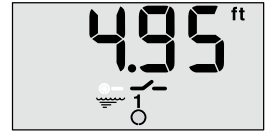
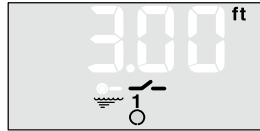
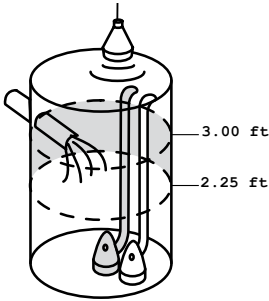
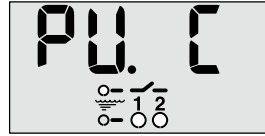

Select the time delay for relay 1 with the arrow keys.

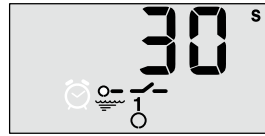

Start and stop level for pump no. 2 is set to 3.75 and 1.50 ft respectively.

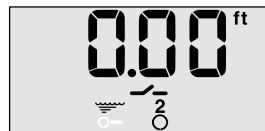
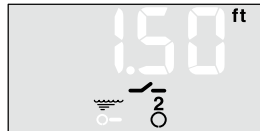
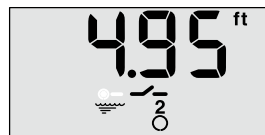
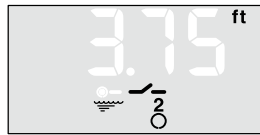
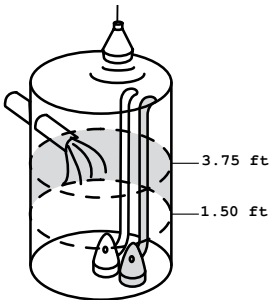

Select the time delay for relay 2 with the arrow keys.

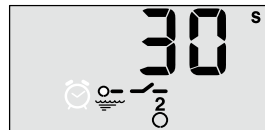

With these start and stop levels Shuttle® is now configured for pumping out and reverts to normal read-out.



Level control with relay 1



In this menu the level for activation (set) of relay 1 is changed from 4.95 to 3.00 ft and deactivation (reset) of the relay output is changed from 0.00 to 1.50 ft.

Select the activation (set) level for relay 1 with the arrow keys.

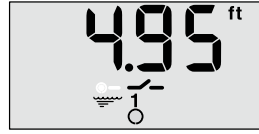
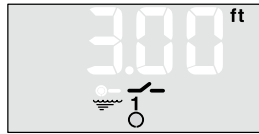
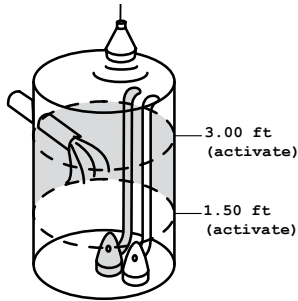

Select the deactivation (reset) level for relay 1 with the arrow keys.

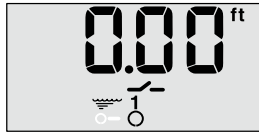
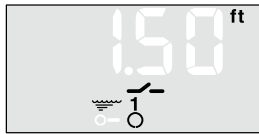

Select the time delay.

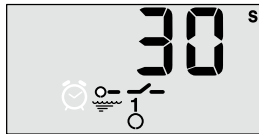

Select relay mode.
(*n.c* = normally closed,
n.o = normally open).

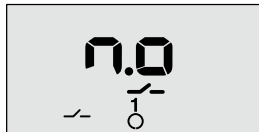
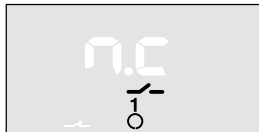

Shuttle® reverts to normal read-out.





System alarm on relay 1

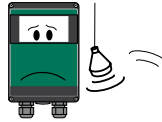

In this menu the time delay is set for the activation of relay 1 when a system error occurs together with the reset position of the relay (normally open / normally closed):



Select the time delay.



Select relay mode.
(*'n.c.'* = normally closed,
'n.o.' = normally open).

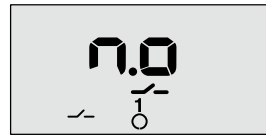
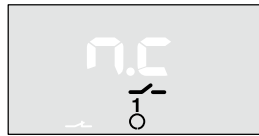

Note: If *'n.c.'* is selected, Shuttle® will also give alarm in case of power failure.



Shuttle® reverts to normal read-out.



Selection of relay function for relay 2

- Two functions are available:
- level control
 - system alarm

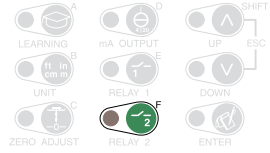

Note: Both relays are already in use if pump control has been selected earlier.



Select the desired function.

Level control:
Continue on the facing page.

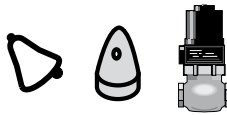

System alarm:
See page 27.

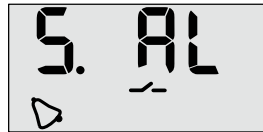
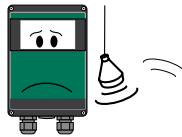



Level control with relay 2



In this menu the level for activation (set) of relay 1 is changed from 4.95 to 3.00 ft and deactivation (reset) of the relay output is changed from 0.00 to 1.50 ft.



Select the activation (set) level with the arrow keys.

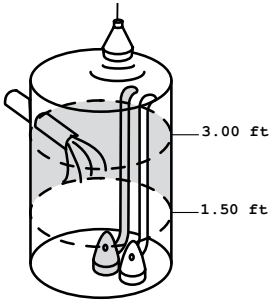
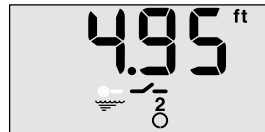
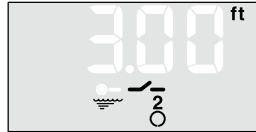

Select the deactivation (reset) level with the arrow keys.

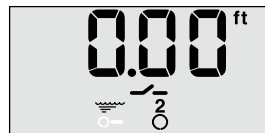
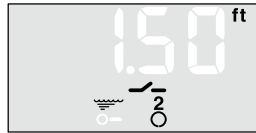

Select the time delay.

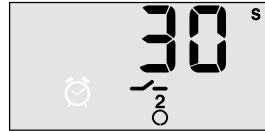

Select relay mode.
(‘n.c.’ = normally closed,
‘n.o.’ = normally open).

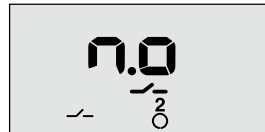
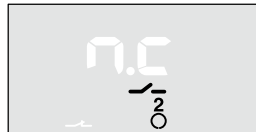

Shuttle® reverts to normal read-out.



System alarm on relay 2

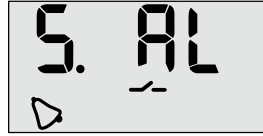
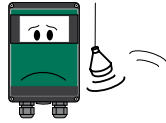

In this menu the time delay is set for the activation of relay 1 when a system error occurs together with the reset position of the relay (normally open / normally closed):

Select the desired time delay.

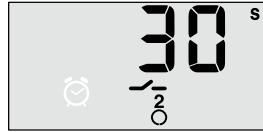

Select relay mode.
(*'n.c.'* = normally closed,
'n.o.' = normally open).

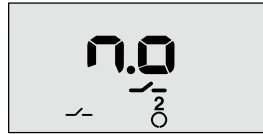
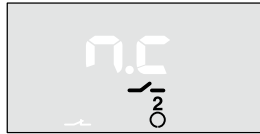

Note: If *'n.c.'* is selected, Shuttle® will also give alarm in case of power failure.

Shuttle® reverts to normal read-out.





Start of the learning function

First time activation

With this function Shuttle® learns if there are any disturbances in the well or tank that could appear as a true echo. Disturbances can result from inlet pipes, the pump installation, a slanted bottom, etc.

Shuttle® stores the levels of the false echoes, which will practically eliminate the chance of locking on a false echo.

Shuttle® will look for a maximum of 15 echos.

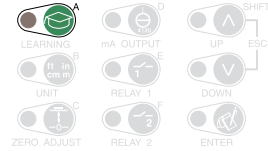

Select the function with the arrow keys.

Note: Only this selection is available if the learning function settings have been erased earlier or the function has never been activated before.



Shuttle® starts to investigate the tank / well for disturbances. The investigation is finished when all segments in the bar graph are lit.

Note: According to the number of disturbing elements, this process may take several minutes.



In this example, Shuttle® has found two false echos ① (the inlet) and ② (from the pump installation) and also the correct echo from the bottom of the well / tank.

Select the level closest to the correct level +/- 6 in (③).

If none of the echos are from a true level measurement, but are all false echos (e.g. a slanted well bottom), select 'nf' (= none found).

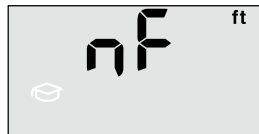
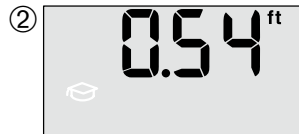
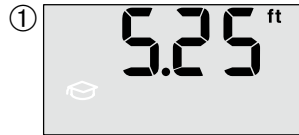
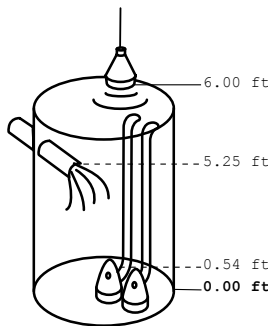

Shuttle® now reverts to normal read-out.

Note: If 'nf' was selected as explained above, Shuttle® will normally indicate system error until a varying echo from a true level surface is detected.



Activating the learning function

Activation / deactivation

This function activates or deactivates the learning function.

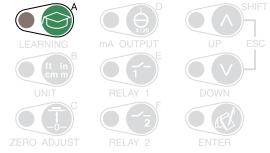

Select with the arrow keys.

If 'OFF' (deactivation) is selected, Shuttle® will still remember the levels of the false echos but will not take them into consideration.

If 'ON' (activation) is selected, Shuttle® will take the false echo levels into consideration.

If 'LRN' is selected, Shuttle® will start a new learning process.

Note: All levels found earlier will be erased.

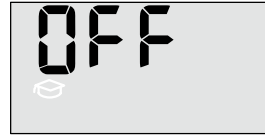

If 'OFF' (or later 'ON') is selected, Shuttle® will revert to normal read-out.



Settings

User settings

Learning function: Off On

Measuring unit: m in ft mm cm

Sensor / zero point distance: _____
Level read-out setting: _____

mA output: 4 mA = _____
20 mA = _____

Relay outputs:

	1	2
Off:	<input type="checkbox"/>	<input type="checkbox"/>
Pump control:	<input type="checkbox"/>	<input type="checkbox"/>
Level control:	<input type="checkbox"/>	<input type="checkbox"/>
System alarm:	<input type="checkbox"/>	<input type="checkbox"/>
Start level:	_____	_____
Stop level:	_____	_____
Relay delay:	_____	_____ sec.
NO/NC:	<input type="checkbox"/> (NC)	<input type="checkbox"/> (NC)

bA Bar graph read-out: Off mA output Level read-out

rA Active measuring range: _____

rE Response time: _____ mm/s

AP Measuring method: 1 2 3

S.Err mA signal at system error: Freeze Fixed signal, _____mA

LE Calibration of level read-out: _____

Factory settings

Off

ft

± 0

± 0

Zero point
4 in from sensor

1	2
<input checked="" type="checkbox"/>	<input checked="" type="checkbox"/>
-	-
-	-
-	-

Zero point
4 in from sensor

30 sec. 30 sec.

(NC) (NC)

Off

From zero point to
14 in from sensor

100 mm/sec.
(4 in/sec)

1 (Fluid)

Freeze

± 0

Possible settings

Learning function: On / Off
 Measuring unit: m / in / ft / mm / cm

① Sensor / zero point distance: ± 99.99 ft
 Level read-out setting: ① ± 99.99 ft

② mA output: ① ± 45 ft minus 4 in
 ② ± 45 ft _____

Start level: From (zero point + distance to sensor) to (max. range - zero point)
 Stop level: From (zero point + distance to sensor) to (max. range - zero point)
 Relay delay: 0 to 300 sec.
 NO/NC: NO / NC

Bar graph read-out: Off / mA output / level read-out

Active measuring range: 4 in to max. range

Response time: 0.1 to 300 mm/sec. (4/1000 to 11.8 in)

Measuring method 1 (Fluid) / 2 (Sludge and granulate) / 3 (Rapid level changes)

mA signal at system error: Freeze / Fixed signal. (Fixed signal can be set from 3,5 to 20 mA)

Calibration of level read-out: ± 5.9 in

Trouble shooting

General

Almost all system errors are due to the echo from the ultrasonic sensor being either too weak or missing. This is normally caused by incorrect installation of the ultrasonic sensor, a faulty ultrasonic sensor or by faults on the cable between the ultrasonic sensor and the Shuttle® level meter. Other factors also have an influence on the ultrasonic level measurement. But always check first that the ultrasonic sensor is installed correctly and is working properly. See also the fault finding table on the facing page.

Indications on system errors

First, Shuttle® will indicate that the echo is too weak or missing. After 5 minutes Shuttle® displays 'S.Err', and if one of the relays is set to be activated on a system error, the relay will be activated after the delay time. At the same time the signal from the mA output will be either locked on the last known value or provide a preset signal value (3.5 - 20.5 mA). Other valid error types are temperature errors, internal stack errors and EE-PROM errors (see below).

If the problem disappears, Shuttle® will change back to normal read-out. At the same moment, the relay output set as alarm output will switch back to its normal position and the mA output will provide a normal signal.

Normal read-out

Shuttle® receives an echo that has sufficient strength for a safe and reliable level measurement.

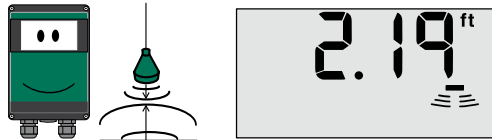

Too weak or missing echo

The received echo is too weak for Shuttle® to perform a safe and reliable level measurement.

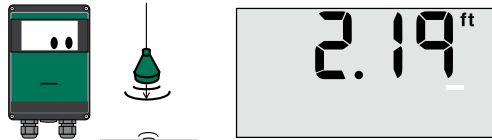

System (sensor) error

If echo is still weak after 5 minutes, Shuttle® enters system error mode and sends an alarm. Also, relays configured for pump control will be deactivated.



Temperature error

Contact an MJK service representative, if a temperature error appears.

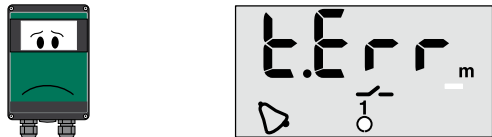

Internal stack error

Contact an MJK service representative, if an internal stack error appears.

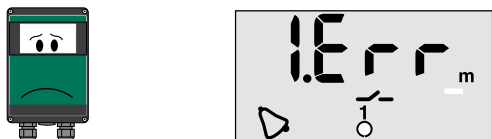

EE-PROM error

Contact an MJK service representative, if an EE-PROM error appears.

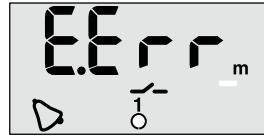

Power failure

If one of the relay outputs is set to NC (normally closed), an external alarm is immediately sent out at power failure.

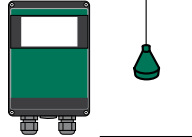

Trouble shooting table

Problem	Cause	Remedies
The display is not lit	Power supply	Wire mounting Is min. 0.4 in (13/32 in) of the insulation removed and firmly mounted?
		AC supply Is correct live voltage present between terminals L and N? Is the right-hand fuse (40 mA@230 VAC, 100 mA@115 VAC) intact? Exchange if necessary.
		DC supply Is 10 - 30 VAC present between terminals 10 and 12, and is the polarity correct? Is the left-hand fuse (200 mA) intact? Exchange if necessary.
Shuttle® indicates system error	Liquid surface	Measuring method (Shift + D) Is the liquid surface foamy? Try changing the setting for measuring method from 'AP 1' to 'AP 2'.
	Ultrasonic sensor	Wire mounting Is a minimum of 0.4 in (13/32 in) of the insulation removed and the wires firmly mounted? Are the wires connected to the correct terminals? See the connection diagram.
		Cable extensions Are there water in the connections, and are the extensions made correctly?
		Condition Is the black part of the sensor discoloured or cracked? Discolouring indicates that the sensor is not suited for the environment on the installation site.
		Function Is the sensor transmitting clicking sounds? If not, the sensor is faulty.
		Sensor mounting Is the sensor mounted ABSOLUTELY VERTICAL? It is extremely important that the sensor is firmly mounted in a vertical position. See the section 'Mechanical mounting of sensor'.
		Measuring distance Is the sensor mounted so that the measuring distance is less than the deadband and more than the max. range? The max./min. measuring range must not be exceeded.

Shuttle® indicates system error constantly	Shuttle®	Setting	Is the setting of the active measuring range (Shift + B) correct? The active measuring range must not be set lower than the max. possible level.
Level read-out is not changing	Ultrasonic sensor	Sensor mounting	Is the sensor mounted ABSOLUTELY VERTICAL? It is extremely important that the sensor is firmly mounted in a vertical position. See the section 'Mechanical mounting of sensor'.
		Installation site	Are there for example bit, fatty accumulations or other objects disturbing the ultrasonic signal?
		Setting	Has the learning function been activated? If the learning function has not been activated, Shuttle® may lock on a false echo.
Level read-out is wrong	Ultrasonic sensor	Sensor mounting	Is the sensor mounted ABSOLUTELY VERTICAL? It is extremely important that the sensor is firmly mounted in a vertical position. See the section 'Mechanical mounting of sensor'.
		Cable	Is the sensor cable extended with a not-approved cable type and/or extended beyond 300 ft?
		Installation	Does the ultrasonic sensor have the same temperature as the ambient air? Deviations will produce measuring errors!
	Shuttle®	Setting	Shuttle® level readout may need adjustment (zero-point adjustment)
Level read-out is unstable	Ultrasonic sensor	Sensor mounting	Is the sensor mounted ABSOLUTELY VERTICAL? It is extremely important that the sensor is firmly mounted in a vertical position. See the section 'Mechanical mounting of sensor'. Is the sensor mounted firmly? The sensor should be mounted on a suitable bracket.
		Installation site	Turbulence on the surface. Objects on the surface that disturb the measurement. Strong winds can bend off the echo, so it misses the ultrasonic sensor.
	Shuttle®	Setting	Response time (Shift + C) is set too low.

Ex Instructions



Quick Installation Guide - FM-approved MJK Ultrasonic Sensors

MJK Ultrasonic Sensor Installation

MJK Automation A/S offers a variety of FM-approved ultrasonic sensors for the MJK Shuttle® Level Converter, the MJK 704 Pump Controller and the MJK 713 Open Channel Flow Converter. This quick guide solely covers mounting and installation of the FM-approved MJK Shuttle sensors in hazardous locations.

- Shuttle® Ultrasonic Sensor Type 200630 - Extended Range w/ 39 ft. cable
- Shuttle® Ultrasonic Sensor Type 200631 - Extended Range w/ 150 ft. cable



Shuttle®Ultrasonic Sensor: 200630 (200631)	
Range:	75 ft. (fluids), 30 ft. (solids)
Frequency:	30 kHz
Spread:	6°
Deadband:	32"
Temperature:	- 5 °F to + 150 °F
Materials:	PBF/ceramic

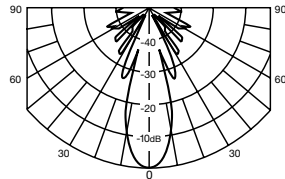

- Shuttle® Ultrasonic Sensor Type 200640 - Standard Range w/ 39 ft. cable
- Shuttle® Ultrasonic Sensor Type 200641 - Standard Range w/ 150 ft. cable



Shuttle®Ultrasonic Sensor: 200640 (200641)	
Range:	35 ft. (fluids), 15 ft. (solids)
Frequency:	40 kHz
Spread:	7°
Deadband:	14"
Temperature:	- 5 °F to + 150 °F
Materials:	PBF/ceramic

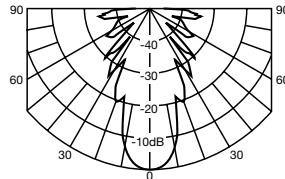

- Shuttle® Ultrasonic Sensor Type 200650 - Short Range w/ 39 ft. cable
- Shuttle® Ultrasonic Sensor Type 200651 - Short Range w/ 150 ft. cable



Shuttle®Ultrasonic Sensor: 200650 (200651)	
Range:	10 ft. (fluids), 4 ft. (solids)
Frequency:	75 kHz
Spread:	7°
Deadband:	14"
Temperature:	- 5 °F to + 150 °F
Materials:	PBF/ceramic

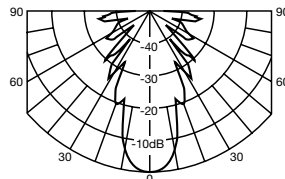

See comprehensive information about the MJK Shuttle® Level Converter, the MJK 704 Pump Controller and the MJK 713 Open Channel Flow Converter in their respective data sheets, installation and user manuals.

Sensor Installation in Class I, II and III, Div. 1 & 2, A, B, C, D, E, F, G Hazardous Locations

Quick Installation Guide - FM-approved MJK Ultrasonic Sensors

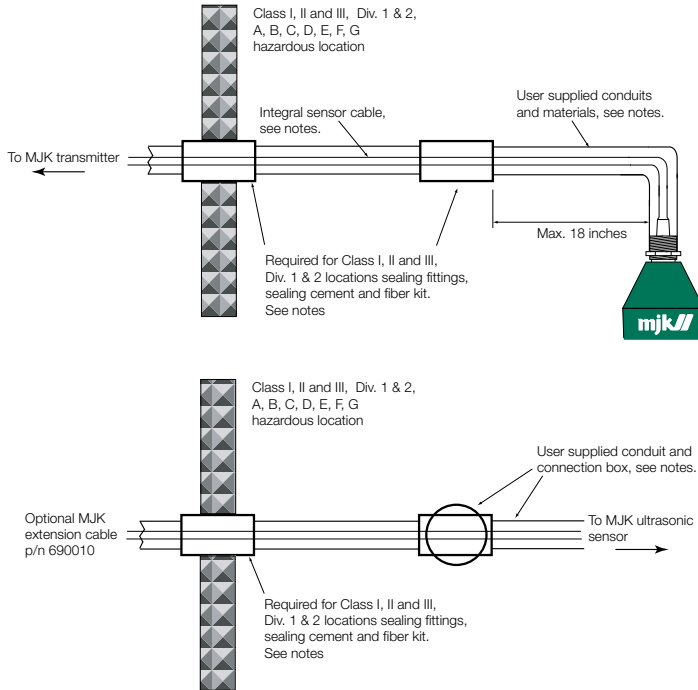

Notes for customer supplied materials and services

1. Cables, fittings and conduits must be installed by the customer in accordance with NEC 501-4, 502-4 or 503-3.
2. In Class I, II and III, Div. 1 & 2, A, B, C, D, E, F, G hazardous (classified) locations all seal fittings, sealing compounds, connections boxes, conduits, fittings, etc. must be certified and approved for use in the above mentioned locations.
3. Minimum thread engagement between all threaded joints must be a maximum of 5 full threads.
4. Interconnecting cable conduits and fittings must be grounded to a proper electrical ground. Bonding between all conduit connections must be provided and installed by the customer as part of installation.
5. The sensors are provided with an integral cable. An extension cable must MJK cable, part no. 690010.
6. The cable must be run in accordance with NEC (ANSI/NFPA 70), CEC pt. I and/or applicable local code requirements.
7. This installation guide is under MJK control, and modifications are not allowed without consent from the certifying authority.

MJK offices:	Denmark www.mjk.dk mjk@mjk.dk +45 45 56 06 56	The Netherlands www.mjk.com mjknl@mjk.com +31 251 672171	North America www.mjk.com mjkuasa@mjk.com +1 847 482 8655
	Norway www.mjk.no mjk@mjk.no +47 69 20 60 70	Sweden www.mjk.se kontoret@mjk.se +46 53 31 77 50	Australia www.mjk.com mjk@mjk.com +61 3 9755 1529

A Technical specifications

Shuttle® Level Transmitter	
Measuring range	0 - 75 ft
Span	From 0 - 4" to 0 - 75 ft
Power supply	115 / 230 V AC, 10 - 30 V DC
Consumption	2 W
Temperature	- 5 to + 150 °F
Input	From ultrasonic sensor
Accuracy	Better than $\pm 0,2\%$ ①
Outputs	Analogue: 1 pc. 4 - 20 mA, max. 500 Ω loop impedance. Digital: 2 pcs. relays with connect or disconnect function (NO/NC). Max. 50 V DC, 1 A ohmic / 50 V AC, 50 VA.
Display	LCD with 4 digits and symbols
Operation	Function keys behind the front cover
Enclosure	NEMA 4X
CE approvals	EN 50081-1, EN 50082-1

① The accuracy is stated for the selected measuring range with the sensor mounted 14 in above highest possible level and with subsequent calibration of level readout as explained on page 52 and when measuring on an even surface without foam build-up or other disturbing objects.

Dimensions

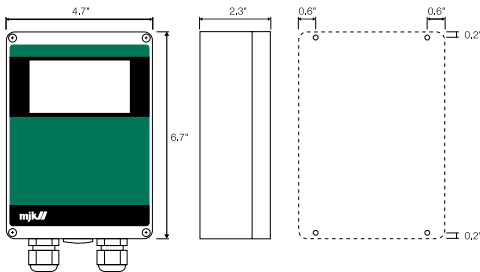

Shuttle® Level Transmitter

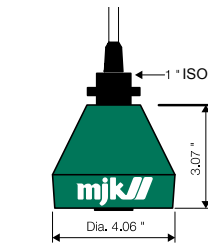

Shuttle® Ultrasonic Sensor

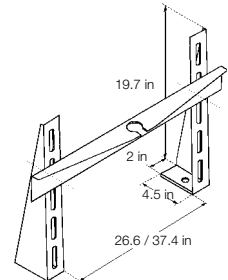
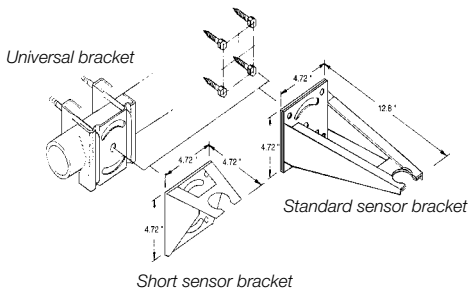

Sensor bracket for channel or flume

Shuttle® Ultrasonic Sensors

Standard Range Version



Shuttle® Ultrasonic Sensor Type 200570	
Measuring range	45 ft (liquids), 18 ft (solids)
Frequency	30 KHz
Spread	3 °
Dead band	14 in
Sensitivity	See figure below
Temperature	- 5 to + 150 °F
Materials	PP (green), POM (black)
Cable	Shielded, insulated with oil resistant PVC, length 39 ft (Max. 300 ft with 690010 cable)
Enclosure	NEMA 6P, water-proof, withstands submerging, max. 1 bar
CE approvals	EN 50081-1, EN 50082-1

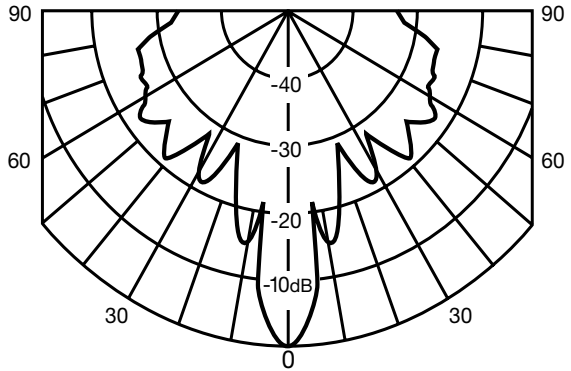

Standard Range Version/FM Approved



Shuttle® Ultrasonic Sensor Types 200640 / 200641	
Measuring range	35 ft (liquids), 15 ft (solids)
Frequency	40 KHz
Spread	7 °
Dead band	14 in
Sensitivity	See figure below
Temperature	- 5 to + 150 °F
Materials	VALOX
Cable 200640:	Shielded, insulated with oil resistant PVC, length 39 ft.
Cable 200641:	Shielded, insulated with oil resistant PVC, length 150 ft (Max. 300 ft with 690010 cable)
Enclosure	NEMA 6P, water-proof, withstands submerging, max. 1 bar
CE approvals	EN 50081-1, EN 50082-1
Ex approvals	FM Class 1, Div. 1, Group A-G

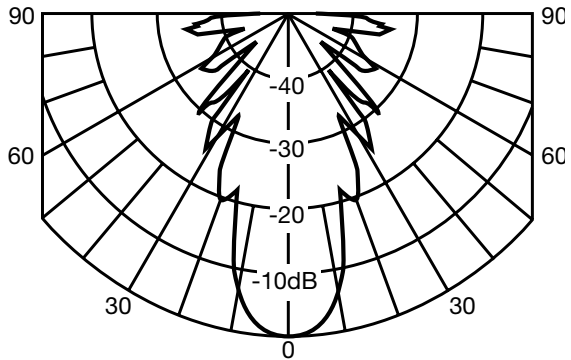

Extended Range Version



Shuttle® Ultrasonic Sensor Types 200630 / 200631	
Measuring range	75 ft (liquids), 30 ft (solids)
Frequency	30 KHz
Spread	6 °
Dead band	32 in
Sensitivity	See figure below
Temperature	- 5 to + 150 °F
Materials	VALOX
Cable 200630:	Shielded, insulated with oil resistant PVC, length 39 ft.
Cable 200631:	Shielded, insulated with oil resistant PVC, length 150 ft (Max. 300 m with 690010 cable)
Enclosure	NEMA 6P, water-proof, withstands submerging, max. 1 bar
CE approvals	EN 50081-1, EN 50082-1
Ex approvals	FM Class 1, Div. 1, Group A-G

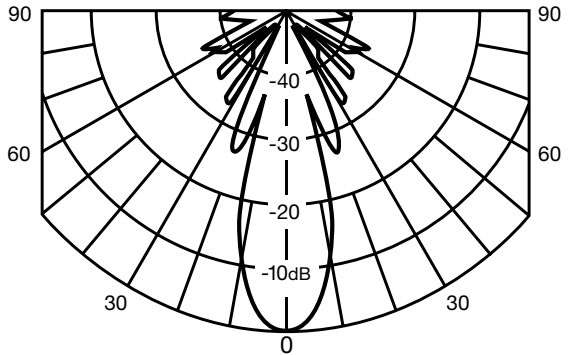

Chemical Resistant Version



Shuttle® Ultrasonic Sensor Type 200660	
Measuring range	30 ft (liquids), 15 ft (solids)
Frequency	50 KHz
Spread	6 °
Dead band	14 in
Sensitivity	See figure below
Temperature	- 5 to + 150 °F
Materials	PP, PVDF
Cable	Shielded, insulated with oil resistant PVC, length 39 ft (Max. 300 ft with 690010 cable)
Enclosure	NEMA 6P, water-proof, withstands submerging, max. 1 bar
CE approvals	EN 50081-1, EN 50082-1

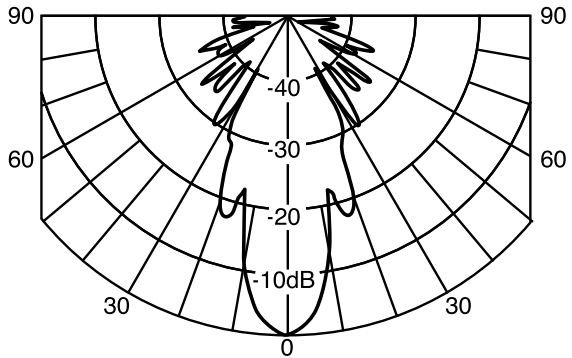

B Changing supply voltage

- 1: Remove the lid, detach the wires from the terminal blocks and remove the four screws that hold the electronics in the cabinet.



- 2: Take out the electronics and turn it around.

Look at the upper left corner and look if two soldering brackets (pos. B) are mounted and if the conducting branch (pos. A) is broken or not.

- two soldering bridges are mounted (pos. B) and the conducting branch (pos. A) is broken: Shuttle® is intended for 115 V AC.
- no soldering bracket is mounted (pos B) and the conducting branch (pos. A) is not broken: Shuttle® is intended for 230 V AC.

Conversion from 115 to 230 V AC

Remove the two soldering brackets between the soldering points (pos. B). Close the conducting branch (pos A). Turn around the electronics and exchange the *rightmost* fuse to a 40 mA fuse.

Conversion from 230 to 115 V AC

Mount two soldering brackets between the soldering points (pos. B) and break the conducting branch or drill out the soldering point (pos A).

Turn around the electronics and exchange the *rightmost* fuse to a 100 mA fuse.



The rightmost fuse should be rated 100 mA @ 115 VAC or 40 mA @ 230 VAC.

- 3: Mount the electronics in the cabinet, mount the wires in the terminal blocks and mount the lid.

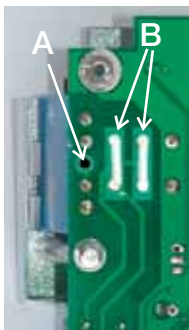

115 V AC

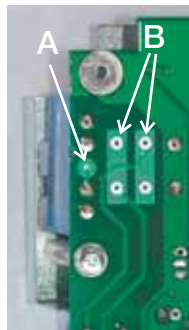

230 V AC

C Sensor mounting considerations

General

The ultrasonic sensor is characterized by a very narrow spread of the ultrasonic signal (3° - 7° depending on the type of sensor), which makes it possible to use the ultrasonic sensor under very tight conditions, i.e. in narrow wells or tanks. 80 % of the ultrasonic signal is concentrated within this area, which will give a sufficient echo in the far most cases.

It is required though, that the ultrasonic signal is not being muffled or disturbed by gratings, pipes, cables etc., and that the ultrasonic sensor is not mounted so the ultrasonic signal is sent too close to a tank wall or well wall.

The spread of the ultrasonic signal

The illustration to the left shows the spread of the ultrasonic sensor in conjunction with the measuring distance, the ultrasonic signal spread will be **23 in** at a measuring distance of **30 ft**.

Accordingly, as the measuring distance increases, the distance from the center line to a **smooth wall** should also be increased.

Distance (feet)	Spread (inch)			Min. dist. from wall (inch)		
	3°	6°	7°	at 3°	at 6°	at 7°
3	6	8	8	3	4	4
6	8	11	13	4	6	6
9	10	15	17	5	8	8
12	11	19	21	6	9	11
15	13	23	26	7	11	13
18	15	26	30	8	13	15
21	17	30	34	8	15	17
24	19	34	39	9	17	19
27	21	37	43	10	19	21
30	23	41	47	11	21	24
33	24	45	52	12	22	26
36	26	49	56	13	24	28
39	28	52	60	14	26	30
42	30	56	65	15	28	32
45	32	60	69	16	30	34

Table 1: The ultrasonic signal spread along a smooth wall and minimum distance to center line in conjunction to the measuring distance.

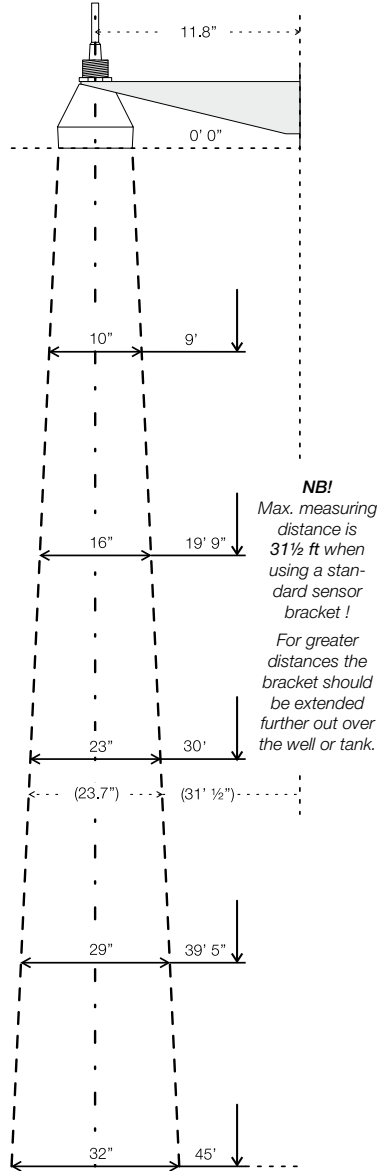

Figure 1: The signal spread in conjunction with the measurement distance. The signal spread should be increased by 50 - 100 % if the surface is not smooth!

Measurements

Along a wall / other surface

The values in table 1 assume the ultrasonic signal is sent along a *smooth surface like a wall or plane without any projections, joints, butts etc.*

If the surface is not smooth or has projections (i.e. joints on prefab elements), the ultrasonic signal will be impeded too much, and for that reason *the values for minimum distance to wall in table 1 should be increased with 50 to 100 % !*

Through a concrete deck

When the ultrasonic sensor is measuring through a concrete deck, the dimension of the opening should be made as shown below: (See table 1 for the sensor spread.)

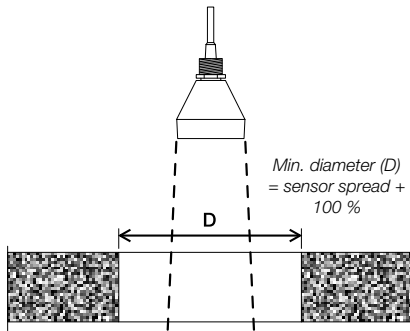

Measurement through a concrete deck with sharp edge.

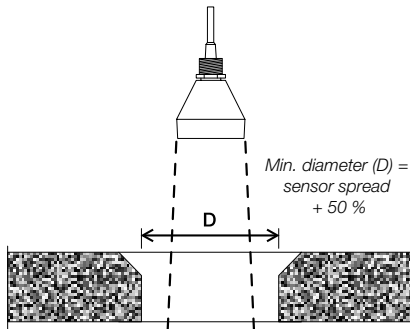

Measurement through a concrete deck with 45 - 60 ° edge cutoff.

In a tank / container

If the ultrasonic sensor is mounted for measurement of the level in a closed tank or container, it should measure through a pipe with a cutoff as shown below:

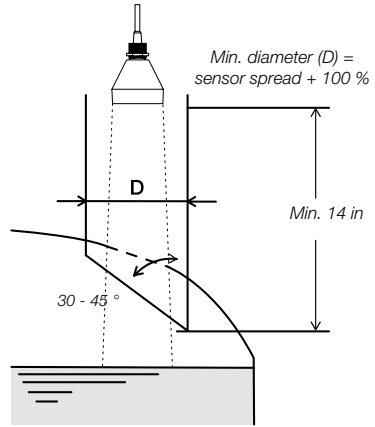

Measurement in a closed container or tank.

Through pipe for foam protection

When measuring on liquids prone to build up foam on the surface, it is often necessary to measure through a pipe, since the build up of foam rarely will occur inside the pipe.

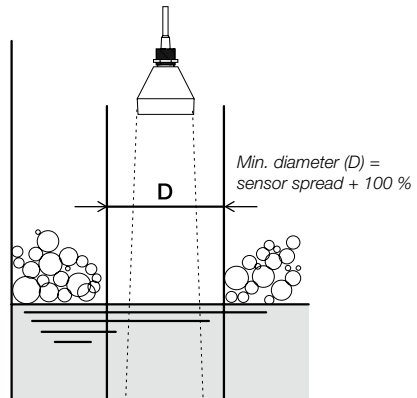

Measurement through a pipe for foam protection.

D Service menu

Shuttle® has a service menu that gives access to settings that normally are not altered by the user and therefore are protected by a password.

The service menu includes:

- adjustment of the 4-20 mA output
- adjustment of the temperature compensation
- functional control of keyboard and display
- relay check
- changing of serial number and hardware/software numbers
- self test function

Refer to 'Shuttle® Service Manual' for further information of the functions in the service menu.

E Special menus

Under certain circumstances it may be necessary to make adjustments and to make readings in the following special menus.

It is recommended that only experienced users and MJK service technicians make alterations in these menus.

The following menus are not protected with an access code:

- Bar graph read-out
- Active measuring range
- Response time
- Measurement method
- mA output value during system error
- Calibrator of level readout
- Offset level readout
- Indication of echo signal quality
- Indication of signal amplification
- Indication of period length without echo
- Selection of factory presets

The following menus are protected with an access code:

- Readout of version numbers
- Find zero level on next power-up
- Fixed mA signal
- Interval between investigative measurements
- System alarm delay
- Averaging the level measurement
- Max. amplification level
- Min. level for accept of ultrasonic echo
- Sensitivity of the learning function
- Changing the access code

Bar graph read-out

This function is used to select whether the bar graph should follow the analog output or the level read-out.

Changes will not have influence on the relay settings.

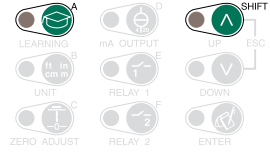

The bargraph follows the analog output.

Note: If the mA settings are inverted (the level reference at 4 mA is set higher than the level reference at 20 mA), the bar graph will increase when the level decreases and vice versa.

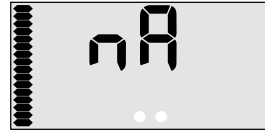

The bar graph follows the level read-out.

Note: If the active measuring range has been decreased to i.e. 4.50 - 9 ft (see next page), the range of the bar graph will be changed accordingly (all segments lit at 9 ft and all segments off at 4.5 ft.)

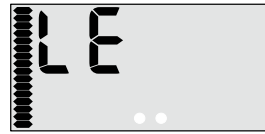

The bar graph is deactivated.



Shuttle® reverts to normal read-out.



Active measuring range

Shuttle®'s measuring range is normally set automatically to a distance corresponding to the ultrasonic sensor's distance to zero level + 1.5 ft.

It may become necessary to decrease the active measuring range so it corresponds to the highest and lowest possible levels in the well /tank - especially if the ultrasonic sensor is mounted above a steel grating or an opening in a well cover.

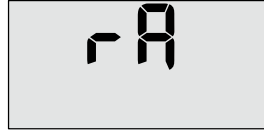
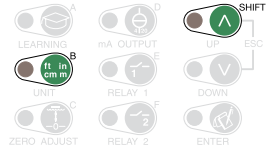

In this example, the Shuttle®'s active measuring range are decreased from **14 in - 45 ft** to **4.50 - 9 ft** measured from the sensor - that is **9.00 ft** from the bottom to **4 in** below the grating or cover.

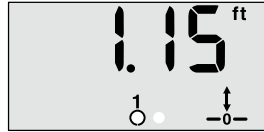

Set the start distance of the measuring range measured from the ultrasonic sensor (i.e. the highest possible level).

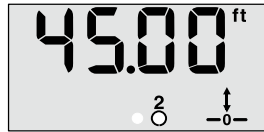
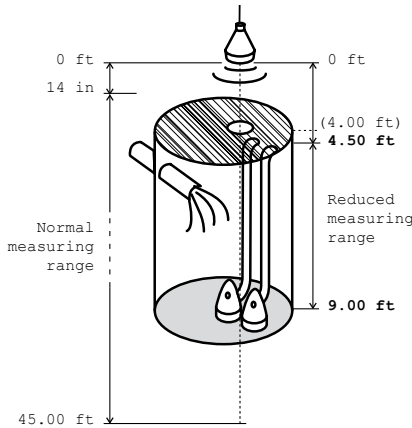
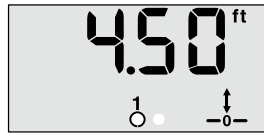

Set the stop distance of the measuring range measured from the ultrasonic sensor (i.e. the lowest possible level).

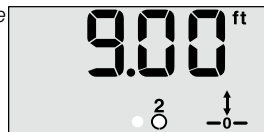

Shuttle® reverts to normal read-out.



Response time

When the level changes, the display read-out will change accordingly with a pre-programmed delay.

The response time is set to 100 mm/sec. (= 4 in./sec.) from the factory, which means that an actual level change will not be shown in the display at a faster rate than 4 in per second.

When measuring on turbulent surfaces, it may become necessary to increase the response time in order to obtain a more stable level measurement and also relay function.

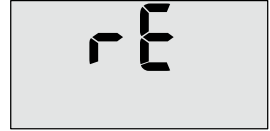
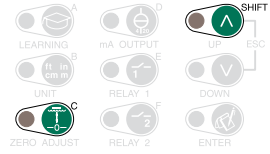

Select the desired response time with the arrow keys.

Note: Changing the response time will also change the response time for the mA output and the time for exceeding the set/reset levels.

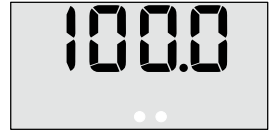

Shuttle® reverts to normal read-out.



Measuring method (application)

Shuttle®'s high accuracy is partly obtained by controlling the strength of the ultrasonic pulse based on the strength of the received echo. (AP 1)

When performing level measurements on foaming surfaces, granulate, sludge etc., the received echo is generally so weak that it would be better to let Shuttle® send out the ultrasonic pulses with full strength constantly. (AP 2)

Also, when performing level measurements on surfaces with very rapid level changes, it can be necessary to moderate the influence of the learning function (see also page 28) to prevent Shuttle® from locking on false echos. (AP 3)

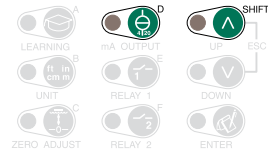

Select measuring method with arrow keys.

If 'AP 1' is selected, the ultrasonic pulse will be controlled in accordance with the strength of the received echo.

'AP 1' should normally be selected for fluid applications.

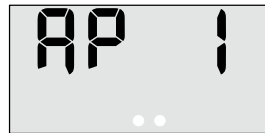

If 'AP 2' is selected, Shuttle® will transmit with full strength constantly.

'AP 2' should normally be selected for sludge / granulate applications.

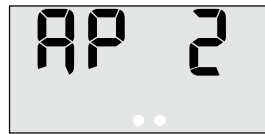

If 'AP 3' is selected, Shuttle® will be better to catch rapid level changes.

'AP 3' should normally be selected for measuring in sludge containers, grating matter or other aqueous matter.

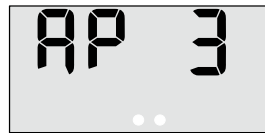

Shuttle® reverts to normal read-out.



mA output signal during system error

This function determines how the mA output should act in case of a system error.

System errors are most often caused by a weak or missing ultrasonic echo, but may also occur by failure of the ultrasonic sensor or failure in Shuttle®'s internal circuits.

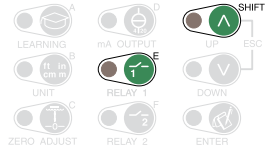

Select the desired condition with the arrow keys.

The mA output will be locked on the last known value when a system error occurs.

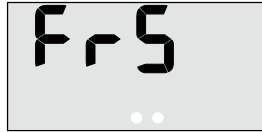

The mA output will give a fixed signal when a system error occurs.

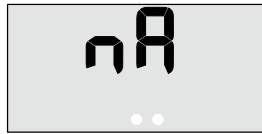

Select the desired value (0.35 to 20.5 mA) of the fixed signal with the arrow keys.



Shuttle® *reverts to normal read-out.*



Calibration of the level measurement

If the distance of the ultrasonic sensor above the surface is known, it will be possible make a calibration of Shuttle®'s level read-out.

The calibration will only have influence on the level read-out - not on relay setpoints for pump control, alarms etc.

Note: *Because of the built-in temperature compensation, it is important that the ultrasonic sensor has the same temperature as the surrounding air. Leave the sensor in the surrounding air for minimum 1 hour.*

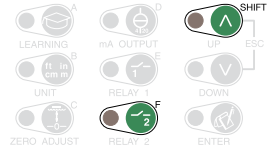

Select the desired correction with the arrow keys.



If the learning function has been activated, Shuttle® will deactivate the learning function and erase the suspicious levels that were found last time the learning function was activated.

The learning function must therefore both be started and reactivated again.

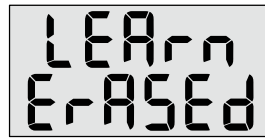

If the relay outputs are configured for pump control, the relays will be deactivated, but their limit settings will not be erased. Also, delay settings and other settings will not be erased.

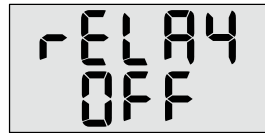

Shuttle® reverts to normal read-out.



Offset level readout

Shuttle® can display the levels with reference to a selectable offset level (datum).

This means that the normal zero level (when the tank is empty) is displaced up or down.

Note: *It is very important, that the distance from sensor to zero is set correctly (see page 18), and that the active measuring range (see page 48) is set to a distance, that corresponds to the longest measuring distance that can occur.*

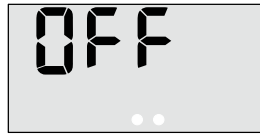
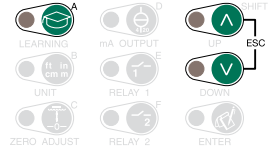

Shuttle® will now display the level as the distance from sensor to zero.

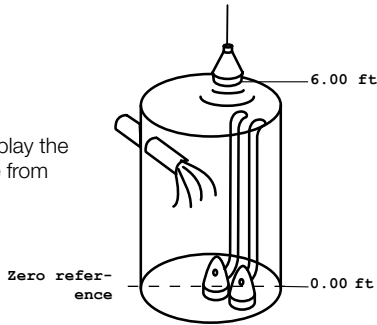

Select the desired zero reference with the arrow keys and confirm with 'Enter'.

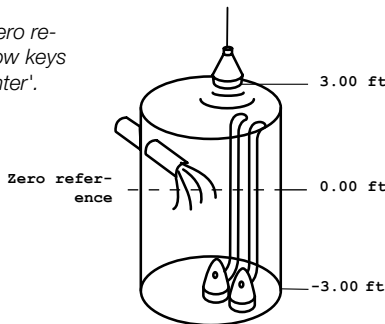

Shuttle® reverts to normal read-out. Every 5 seconds the display indicates that the level readouts are displaced from zero.



Indication of echo quality

This menu is used to indicate the strength of the received ultrasonic echo.

If there are frequent system errors (see page 32), this function can be used to check if the ultrasonic echo is being weakened too much under the current working conditions - i.e. foam, waves etc.

There are no specific limits indicating that the echo is too weak, since it depends highly on the current working conditions. Please contact MJK for advice.

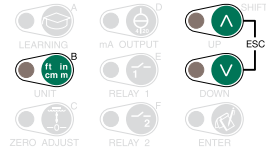

*The strength of the received ultrasonic echo is displayed immediately.
(The strength is shown in percent.)*



Shuttle® reverts to normal read-out.



Indication of signal amplification

This menu is used to display the amplification level of the received ultrasonic echo. The function can give an indication of the strength of the received echo.

If the amplification level is low (below. 20 dB), the echo strength is good and vice versa.

A high amplification level (max. 50 dB) indicate that the ultrasonic echo is weak (foam or waves).

High amplification may in certain situations create other problems with electrical noise from other equipment at the installation site.

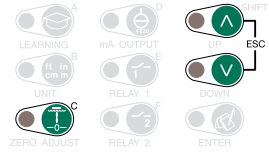

*The amplification level is displayed immediately.
(The level is displayed in dB)*



Shuttle® reverts to normal read-out.



Indication of time period without echo

This menu is used to display the longest time period during which Shuttle® has been missing an acceptable echo, and also how many days has passed since this occurred.

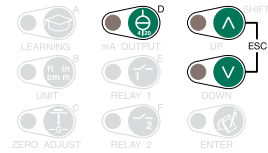

The longest time period that Shuttle® has been missing an acceptable echo is displayed immediately. (In seconds.)



Next, the number of days since the occurrence is displayed. The longest period with echo failure will be erased after 14 days.



Shuttle® reverts to normal read-out.



Select factory settings

All settings - except calibration of the level measurement - made after initial startup will be reset to factory settings with this function.

The zero point setting will also be adjusted to the immediate level in the well / tank. Furthermore, the mA output is set to 4 mA at the current zero point and 20 mA at a level corresponding to a distance of 14 in from the ultrasonic sensor.

Note: The function will cause Shuttle® to start up the same way it did when the supply power was turned on for the first time.

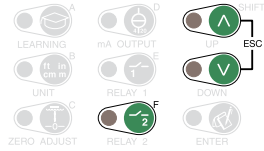

Select 'ON' with the arrow keys.

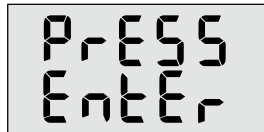

This is shown in the display until Shuttle® detects a valid echo again.

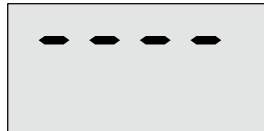

... after which Shuttle® returns to normal read-out.



Access code

To gain access to the remaining menus, an access code is required.

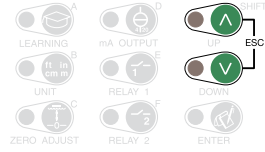

Press and hold 'Escape' in minimum 5 seconds:



The access code can now be selected:

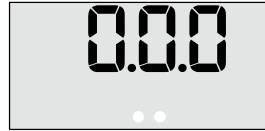

Use the arrow keys to select...
(Standard access code is 100:)

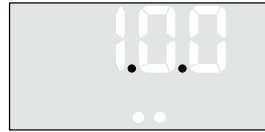

...and confirm with 'ENTER':

All password protected menus can now be selected.
Shuttle® will display the current level readings between menu selections.



Shuttle® will revert to normal readout if:

- 1: the keyboard has not been used within 5 minutes.
- 2: 'Escape' is pressed.

The access code must then be entered again for access to the password protected menus.



Readout of version numbers

Enter the access code (see page 58) and press 'A':

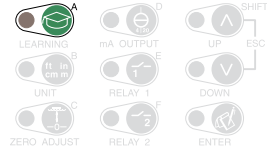

This menu is used to display version numbers for software and hardware and the unit's serial number.

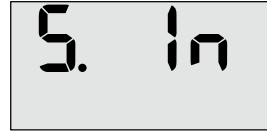

The hardware version number is displayed first:
(Ex.: HW version 838003)
Use the up-arrow to proceed.



The software version number is displayed next:
(Ex.: SW version 838014)
Use the arrows to proceed.

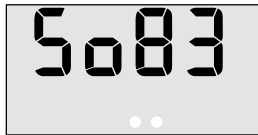

At last the Shuttle®'s serial number is displayed:
(Ex.: serial no. 029400)
Use the down-arrow to proceed.

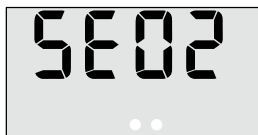

Shuttle® is ready for a new selection of a password protected menu after pressing 'Enter'.
(Re-entering the access code is not necessary if a menu selection is made within 5 minutes.)



Press 'Escape' if no further password protected menu selections are needed ...

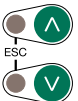

... or confirm with 'Enter' that the changes should be saved, whereupon Shuttle® revert to normal read-out, and the next password protected menu can be selected.
(Press 'Escape' if the changes should not be saved.)



Find zero level at next power-up

Enter the access code (see page 58) and press 'B':

This menu is used to force Shuttle® to start up with an automatic zero level setting at the next power-up. (See page 14.)

The function is useful if ie. Shuttle® has been build into a control panel and has been set-up for a particular application. Shuttle® will then start up as it would when delivered from the factory, but the selected functions and setpoints will not be reset.

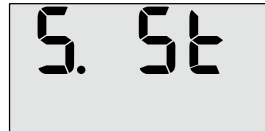
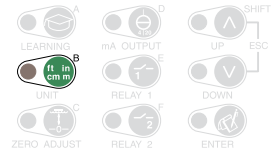

Use the arrow keys to select:



Confirm the new setting:



Shuttle® is ready for a new selection of a password protected menu after pressing 'Enter'.
(Re-entering the access code is not necessary if a menu selection is made within 5 minutes.)



Press 'Escape' if no further password protected menu selections are needed ...

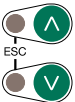

... or confirm with 'Enter' that the changes should be saved, whereupon Shuttle® revert to normal read-out, and the next password protected menu can be selected.
(Press 'Escape' if the changes should not be saved.)



Fixed mA signal

Enter the access code (see page 58) and press 'C'.

This menu is used to make Shuttle® give out a constant 12 mA signal independent of the actual level readout.

The function can be useful during trouble shooting on external equipment.

Note: The output signal is constant 12 mA as long as this display is shown:

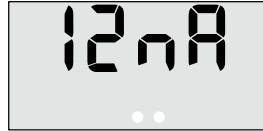
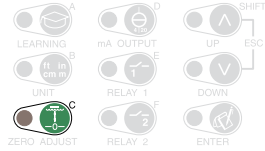

Shuttle® is ready for a new selection of a password protected menu after pressing 'Enter'.

(Re-entering the access code is not necessary if a menu selection is made within 5 minutes.)



Press 'Escape' if no further password protected menu selections are needed ...

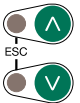
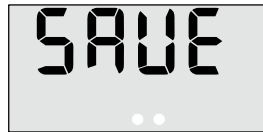

... or confirm with 'Enter' that the changes should be saved, whereupon Shuttle® revert to normal read-out, and the next password protected menu can be selected.

(Press 'Escape' if the changes should not be saved.)



Investigative measurement intervals

Enter the access code (see page 58) and press 'D':

Shuttle® will normally perform an investigative measurement every 5 minutes in order to ensure that the unit has not locked on a false echo - i.e. a level signal which is not the actual level.

If Shuttle® often locks onto solid objects within the normal interval, the interval for investigative measurements can be changed in this menu.

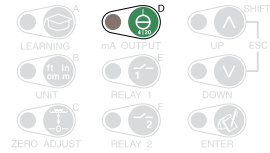

The actual setting is shown immediately:
(Value in seconds.)



Use the arrow keys to select a new value:



Confirm the new setting:



Shuttle® is ready for a new selection of a password protected menu after pressing 'Enter'.
(Re-entering the access code is not necessary if a menu selection is made within 5 minutes.)



Press 'Escape' if no further password protected menu selections are needed ...

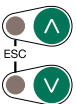

... or confirm with 'Enter' that the changes should be saved, whereupon Shuttle® revert to normal read-out, and the next password protected menu can be selected.
(Press 'Escape' if the changes should not be saved.)



System alarm delay

Enter the access code (see page 58) and press 'E':

Shuttle® will give a system alarm (see page 32), if an acceptable echo has not been present within a preset period of time.

If it is very important to know that the level measurement is valid at all times, the delay should eventually be decreased.

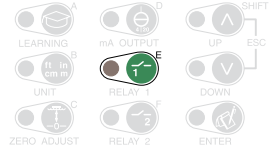

The actual setting is shown immediately:
(Value in seconds.)

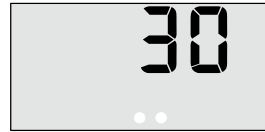

Use the arrow keys to select a new value:



Confirm the new setting:



Shuttle® is ready for a new selection of a password protected menu after pressing 'Enter'.

(Re-entering the access code is not necessary if a menu selection is made within 5 minutes.)



Press 'Escape' if no further password protected menu selections are needed ...



... or confirm with 'Enter' that the changes should be saved, whereupon Shuttle® revert to normal read-out, and the next password protected menu can be selected.

(Press 'Escape' if the changes should not be saved.)



Averaging the level measurement

Enter the access code (see page 58) and press 'F':

When measuring on very turbulent liquid surfaces, it may be needed to average the level changes in order to gain a more steady level readout and level signal.

This menu is used to set the time from a level change is measured and until the reading will be 99 % of the level change.

See also page 49, 'Response time'.

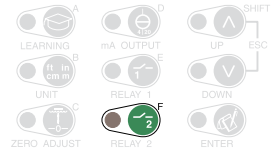

The actual setting is shown immediately:
(Value in seconds.)

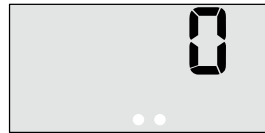

Use the arrow keys to select a new value:



Confirm the new setting:

Note: The variation on the mA output will change accordingly.



Shuttle® is ready for a new selection of a password protected menu after pressing 'Enter'.
(Re-entering the access code is not necessary if a menu selection is made within 5 minutes.)



Press 'Escape' if no further password protected menu selections are needed ...

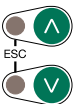

... or confirm with 'Enter' that the changes should be saved, whereupon Shuttle® revert to normal read-out, and the next password protected menu can be selected.
(Press 'Escape' if the changes should not be saved.)



Max. amplification level

Enter the access code (see page 58) and press 'Shift' + 'A':

If Shuttle® periodically has a system error and/or the level readout jumps to a high or low level during measuring in favourable conditions, it may be necessary to limit the amplification of the received echo. (See also page 66.)

The effect from electrical noise can also be reduced or eliminated with this function.

Note: A reduction in the amplification level may affect the maximum measuring range.

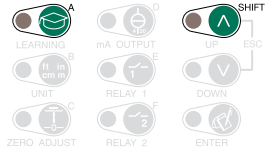

The actual setting is shown immediately:
(Value in dB.)



Use the arrow keys to select a new value:
(5 dB increments.)



Confirm the new setting:



Shuttle® is ready for a new selection of a password protected menu after pressing 'Enter'.

(Re-entering the access code is not necessary if a menu selection is made within 5 minutes.)



Press 'Escape' if no further password protected menu selections are needed ...



... or confirm with 'Enter' that the changes should be saved, whereupon Shuttle® revert to normal read-out, and the next password protected menu can be selected.

(Press 'Escape' if the changes should not be saved.)



Min. level for accept of ultrasonic echo

Enter the access code (see page 58) and press 'Shift' + 'B':

If Shuttle® periodically has a system error and/or the level readout jumps to a high or low level during measuring in favourable conditions, it may be necessary to increase the limit for accept of the ultrasonic echo. (See also page 65.)

On the contrary, it can be necessary to decrease the limit, if it is difficult to get a good echo, e.g. long measuring distances on difficult surfaces.

Note: Changes may affect the possible measuring range.

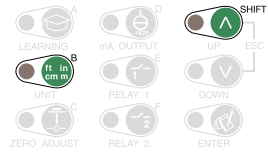

The actual setting is shown immediately:
(Value in seconds.)



Use the arrow keys to select a new value:



Confirm the new setting:



Shuttle® is ready for a new selection of a password protected menu after pressing 'Enter'.
(Re-entering the access code is not necessary if a menu selection is made within 5 minutes.)

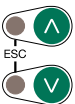

Press 'Escape' if no further password protected menu selections are needed ...



... or confirm with 'Enter' that the changes should be saved, whereupon Shuttle® revert to normal read-out, and the next password protected menu can be selected.
(Press 'Escape' if the changes should not be saved.)



Sensitivity of the learning function

Enter the access code (see page 58) and press 'Shift' + 'C':
 If Shuttle® periodically is locked on a false echo, even if the learning function has been activated (see page 28), it may be necessary to increase the sensitivity of the acoustic image that was stored in Shuttle® during the learning process.

On the contrary, under rare occasions it may be necessary to decrease the sensitivity under particular acoustic occasions, where double echos may occur that causes Shuttle® to lock.

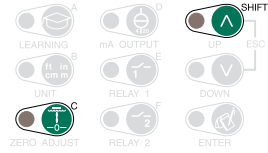

The actual setting is shown immediately:
 (Value in percent.)

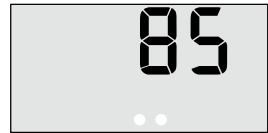

Use the arrow keys to select a new value:



Confirm the new setting:



Shuttle® is ready for a new selection of a password protected menu after pressing 'Enter'.
 (Re-entering the access code is not necessary if a menu selection is made within 5 minutes.)

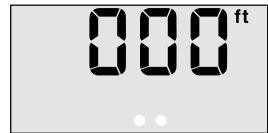

Press 'Escape' if no further password protected menu selections are needed ...

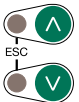

... or confirm with 'Enter' that the changes should be saved, whereupon Shuttle® revert to normal read-out, and the next password protected menu can be selected.
 (Press 'Escape' if the changes should not be saved.)



Changing the access code

Enter the access code (see page 58) and press 'Shift' + 'D'

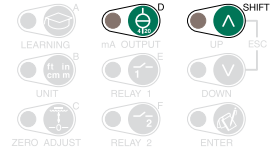

The actual setting is shown immediately:



Use the arrow keys to select a new access code:



Confirm the new setting:



Shuttle® is ready for a new selection of a password protected menu after pressing 'Enter'.

(Re-entering the access code is not necessary if a menu selection is made within 5 minutes.)



Press 'Escape' if no further password protected menu selections are needed ...

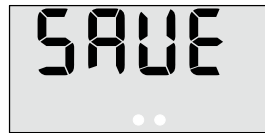
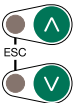

... or confirm with 'Enter' that the changes should be saved, whereupon Shuttle® revert to normal read-out, and the next password protected menu can be selected.

(Press 'Escape' if the changes should not be saved.)



F New sensor / changing sensor

Shuttle® will be shipped and delivered from about July 1, 2007 with 1 of 4 different sensor types.

If, at some other time, the sensor is to be replaced by another or a newer type, the following procedure can successfully be applied to re-configure the level transmitter.

Technical specifications are located on pages 37 - 41.

Open the choose sensor menu

Press 'Esc' + 'E'.

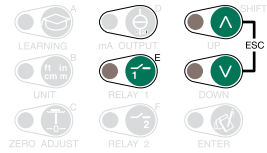

Consequently the (previously) selected sensor type is displayed (here: **20** and **0570** for sensor type 200570):



Press the 'Up' or 'Down' arrow key repeatedly until the following static display appears (**no sensor**):

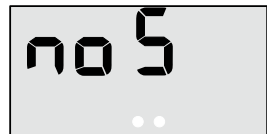

Press 'Enter' twice whereafter the following menu travels across the screen (**Choose Sensor Press Enter**):



Shuttle is now in the opening menu for a Shuttle delivered without a sensor.

Press 'Enter' to enter the choose sensor menu, and press the 'Up' or 'Down' arrow key repeatedly, until the required sensor type appears.

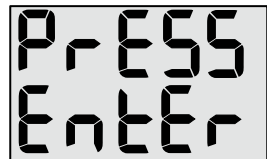

Press 'Enter' to finish the configuration.

See also page 14, 'Get started'.

Note: Once a sensor type has been selected, the factory settings will not alter this selection.



Warranty

MJK products carry a one-year limited warranty against defects in materials or workmanship and that they will comply with written specifications supplied by MJK current at the time of shipment to the customer. The Warranty period begins once the product is installed or otherwise put into operation or 90 days after the date of delivery to the buyer, whichever is soonest. MJK products are not warranted against abuse, misuse, or normal wear and tear. MJK will at MJK's discretion, repair or exchange defective product covered under warranty at no cost to the buyer provided the buyer returns the item, freight prepaid to MJK with a return authorization issued by MJK. The buyer is liable for expenses and risks, associated with return delivery to our company. MJK is not liable for direct or indirect damages due to product failure under warranty or out of warranty.

Liability

MJK North America Inc., an Illinois Corporation, is a subsidiary of the manufacturer, and is the wholesale seller of record, not the retail seller of record. MJK's liability is limited to the costs of its products and services, unless otherwise indicated by state law.

MJK Automation A/S is liable to the common rules of Danish law on product liability, however, the liability is reduced to coverage of our public liability insurance of products. To the extent where nothing else follows in lines of invariable rules of law, we are not liable for loss of profits and working deficits or other indirect losses.

Return of goods

Products custom manufactured to the specifications of a customer cannot be returned, nor can an order for custom products be cancelled except with written permission from MJK. Standard products can only be returned with a return goods authorization issued by MJK. Returns of goods ordered in error or for stock reduction purposes, which are returned unused in their original packaging and in their original condition, will be accepted when return authorization is obtained and with acknowledgement that the buyer will be assessed a 10% restocking charge based on the purchase price of the product. Product credit less the restocking charge will be issued upon inspection of the returned goods by MJK. The buyer is responsible for expenses and risks of return delivery to our company.

Changes

As our products are developed continuously, we reserve the right to make any alterations without prior notice.

MJK North America Inc.
37 Sherwood Terrace, #126
Lake Bluff, IL 60044
Tel.: 847-482-8655
877-MJK-LINK
Fax: 847-482-8654
mjkusa@mjk.com
www.mjk.com