

DRVD PN16, PN25 and PN40

Pressure regulator

Technical Data Sheet



Description

The pressure regulator DRVD maintains automatically the downstream to the set point pressure. The DRVD is insensitive to variations in upstream pressure. It is suitable with water and it is particularly recommended for collective or industrial installations.

- Permissible working pressure adjustment range: 1.5 to 6 bar (standard) or: 2 to 8 bar and 4 to 12 bar
- Model with balanced valve and piston, guaranteeing a very high reliability and longevity
- Body ductile cast iron covered epoxy vanish 250µ
- NBR valve seal
- Flanged connections according to EN 1092-2



DRVD PN16, PN25 and PN40

DN mm	Adjustment range	PFA in bar	PN	Part no.
50	1,5 – 6 bar	16	16	0504053
65	1,5 – 6 bar	16	16	0504068
80	1,5 – 6 bar	16	16	0504083
100	1,5 – 6 bar	16	16	0504103
125	1,5 – 6 bar	16	16	0504128
150	1,5 – 6 bar	16	16	0504153
200	1,5 – 6 bar	16	16	0504203
50	2 – 8 bar	16	16	0504054
65	2 – 8 bar	16	16	0504069
80	2 – 8 bar	16	16	0504084
100	2 – 8 bar	16	16	0504104
125	2 – 8 bar	16	16	0504129
150	2 – 8 bar	16	16	0504154
200	2 – 8 bar	16	16	0504204
50	4 - 12 BAR	16	16	0504055
65	4 - 12 BAR	16	16	0504070
80	4 - 12 BAR	16	16	0504085
100	4 - 12 BAR	16	16	0504105
125	4 - 12 BAR	16	16	0504130
150	4 - 12 BAR	16	16	0504155
200	4 - 12 BAR	16	16	0504205
50	1,5 - 6 BAR	25	25	0504050
65	1,5 - 6 BAR	25	25	0504065
80	1,5 - 6 BAR	25	25	0504080
100	1,5 - 6 BAR	25	25	0504100
125	1,5 - 6 BAR	25	25	0504125
150	1,5 - 6 BAR	25	25	0504150
200	1,5 - 6 BAR	25	25	0504200
50	2 - 8 BAR	25	25	0504051
65	2 - 8 BAR	25	25	0504066
80	2 - 8 BAR	25	25	0504081
100	2 - 8 BAR	25	25	0504101
125	2 - 8 BAR	25	25	0504126
150	2 - 8 BAR	25	25	0504151
200	2 - 8 BAR	25	25	0504201
50	4 - 12 BAR	25	25	0504052
65	4 - 12 BAR	25	25	0504067
80	4 - 12 BAR	25	25	0504082
100	4 - 12 BAR	25	25	0504102
125	4 - 12 BAR	25	25	0504127
150	4 - 12 BAR	25	25	0504152
200	4 - 12 BAR	25	25	0504202

50	1,5 - 6 BAR	40	40	0504056
65	1,5 - 6 BAR	40	40	0504071
80	1,5 - 6 BAR	40	40	0504086
100	1,5 - 6 BAR	40	40	0504106
125	1,5 - 6 BAR	40	40	0504131
150	1,5 - 6 BAR	40	40	0504156
<hr/>				
50	2 - 8 BAR	40	40	0504057
65	2 - 8 BAR	40	40	0504072
80	2 - 8 BAR	40	40	0504087
100	2 - 8 BAR	40	40	0504107
125	2 - 8 BAR	40	40	0504132
150	2 - 8 BAR	40	40	0504157
<hr/>				
50	4 - 12 BAR	40	40	0504058
65	4 - 12 BAR	40	40	0504073
80	4 - 12 BAR	40	40	0504088
100	4 - 12 BAR	40	40	0504108
125	4 - 12 BAR	40	40	0504133
150	4 - 12 BAR	40	40	0504158

Important notice :

The temperature and pressure indications given are under no circumstances a guarantee that they are suitable for your system. Therefore, it is essential to validate the use of the products under given operating conditions with our technical department.

Technical features

Operating temperature	Max: 80°C
Permissible operating pressure (PFA) in water	See table above
Setting range	See table above
Connection	Flanged according to EN1092-2
Gauge connection	Female 8x13 (1/4")
Mediums	Water, other mediums: consult us

Nomenclature and materials

N°	Description	Materials	EURO
1	Body	Cast iron	EN-GJS 400-15
2	Cover	Cast iron	EN-GJS 400-15
3	Flange	Cast iron	
4	Spring disc	Carbon steel galvanized	S235JR
5	Seal support	Brass	CW612N
6	Closing system	Brass	CW612N
7	Sleeve	Bronze	CuSn5zn5Pb-5
8	Ring	Bronze	CuSn5zn5Pb-5
9	Seat	Bronze	CuSn5zn5Pb-5
10	Setting screw	Steel galvanized	
11	Spring	Steel 55 Si 7	
12	Brace washer	NBR	
13	Lip seal	NBR	
14	Steal	NBR	
15	Cover screw	Stainless steel	X5Crni18-10
16	Nut	Steel galvanized	
17	Plug	Brass	CW614N

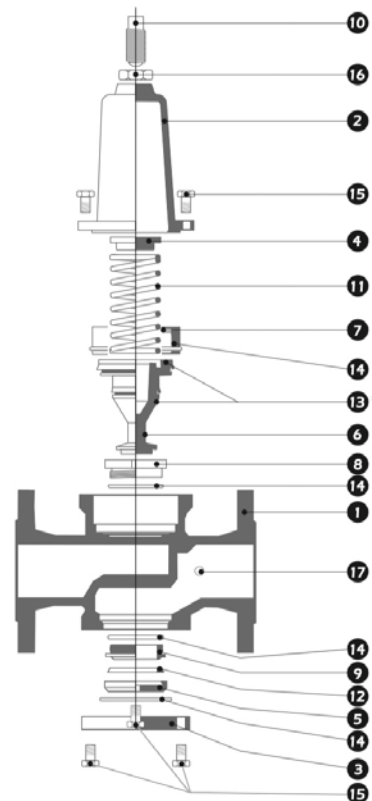

Approvals

ACS

International Construction Standards :

NF EN12266

Flanged connections according to EN1092-2, ISO7005-2

Application

For the protection of cold water and drinking water networks.

The device reduce and stabilize the pressure a the set value whatever the upstream pressure variations and flow in pipes.

The DRVD is ideal for any main pressure reducing or regulation of secondary circuits.

Installation

Check that the piping on which the pressure reducing valve must be installed is clean of welding residues or other waste. It is recommended to install a filter immediately upstream of the pressure regulator and the isolating valves upstream and downstream.

The DRVD has to be installed in horizontal position, respecting the flow rate direction indicated on the valve. We advise to use the horizontal installation to avoid the risk of gasket weakening.

In order to carry out the setting of reduction unit or its maintenance provide sufficient space.

Operation

The downstream pressure acts directly in the control chamber under the upper part of the valve through a particular orifice.

The downstream pressure is balanced at all times by the action of the spring, which causes the valve to move when network flow or pressure varies.

Setting

Adjustable outlet pressure :

- 1,5 at 6,0 bar
- 2,0 at 8,0 bar
- 4,0 at 12,0 bar

The setting of the downstream pressure must be conducted at flow zero.

Loosen the lock nut to release the adjustment screw (N°10 on the nomenclature). Turn the screw in a clockwise direction for more pressure and anticlockwise direction to lower the pressure.

The gauge plugs of the device are in female 8 x 13 (1/4")

Maintenance

It is recommended to ask a professional to check regularly the device.
The device is designed for easy maintenance. Disassembly operations are conducted without removing the device.
Periodically clean the filter placed immediately upstream of the DRVD.

1 - All the internal parts of the DRVD are accessible after removing the cover and the bottom flange (No. 3 on the diagram).

2 - The piston removable by unscrewing the piston screw (or nut piston depending on the diameter of the DRVD) accessible through the bottom flange on the bottom.

Provide a locking plier (e.g.: FACOM N ° 500 Locking plier or a clamp) to maintain the piston with the DRVD body. Assembly the piston-maintained with the locking plier, you can unscrew the piston screw.

3 - Piston screw loose with a standard pipe wrench (e.g.: wrench FACOM N°72) except for the DRVD diameter 125, 150 and 200 where a pipe wrench type "Nervus" is necessary (e.g.: key Nervus FACOM N°92).

The table below shows you the size of the piston screw.

Spring kits (2 at 8 bar)

DN		Designation	Ref.
mm	"		Spare parts
50		DF 8/DRVD 50	166921
65		DF 8/DRVD 65	166923
80		DF 8/DRVD 80	162928
100		DF 8/DRVD 100	162931
150		DF 8/DRVD 150	202166
200		DF 8/DRVD 200	176162

Spring kits (4 at 12 bar)

DN		Designation	Ref.
mm	"		Spare parts
50		DF 12/DRVD 50	167028
65		DF 12/DRVD 65	166924
80		DF 12/DRVD 80	166926
100		DF12/DRVD 100	166927
125		DF 12/DRVD 125	166928
150		DF 12/DRVD 150	167092
200		DF 12/DRVD 200	167103

Seal kits PN16 and PN25

DN		Designation	Ref.
mm	"		Spare parts
50		JT/DRVD	166922
65		JT/DRVD	202174
80		JT/DRVD	162935
100		JT/DRVD	167069
125		JT/DRVD	166929
150		JT/DRVD	162947
200		JT/DRVD	166930

Maintenance kits shown in the table above are available; to order it, is necessary to indicate all information shown on the metal plate placed on the body of the DRVD.

Dimensioning

The sizing is done according to the flow.

Choose the DN which corresponds to speed in the device of 1,5 m/s at the regarded flow.

The speed inside the valve does not have to reach an excessive value that can cause vibrations, noises, head loss or cavitation.

Moreover the exercise temperature have to stay between 0°C and 80 °C.

For a right dimensioning it's necessary to know the followings parameters:

- Upstream hydrostatic pressure
- Required downstream pressure
- Flow rate Q

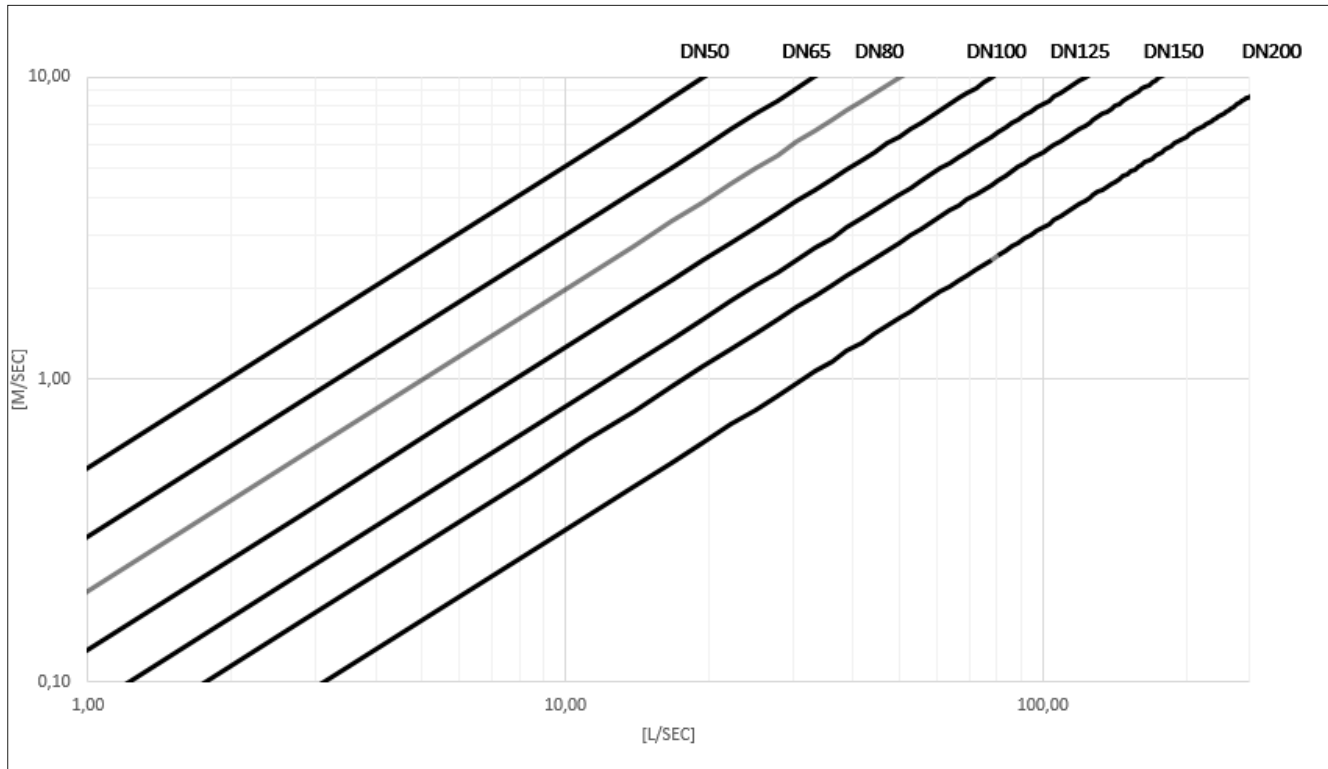

Operating characteristics

DRVD - Headloss chart

Pressure regulator DRVD - 50 and 65

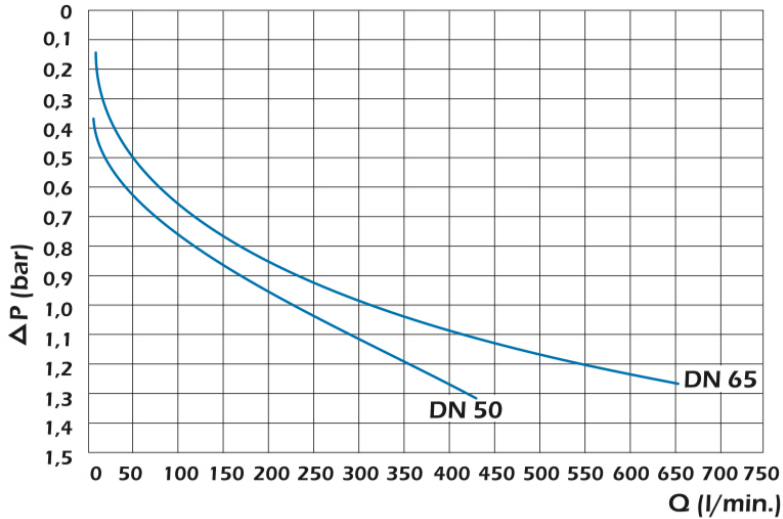

Pressure regulator DRVD - 80 and 100

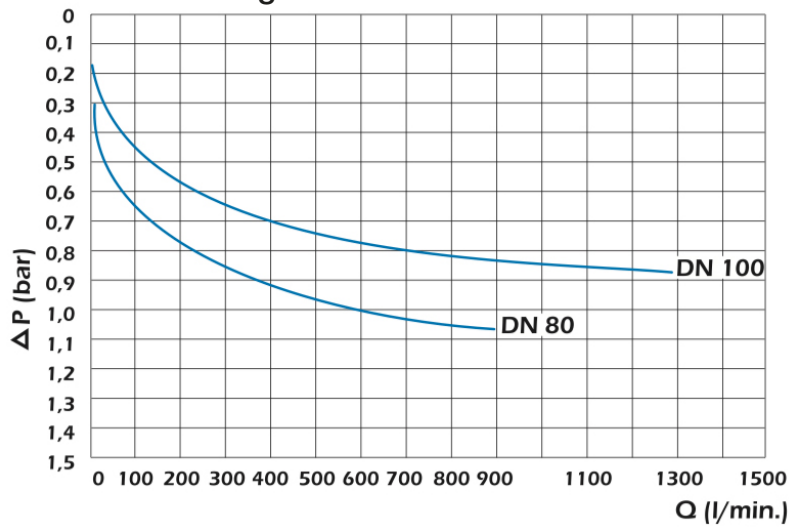

Pressure regulator DRVD - 125, 150 and 200

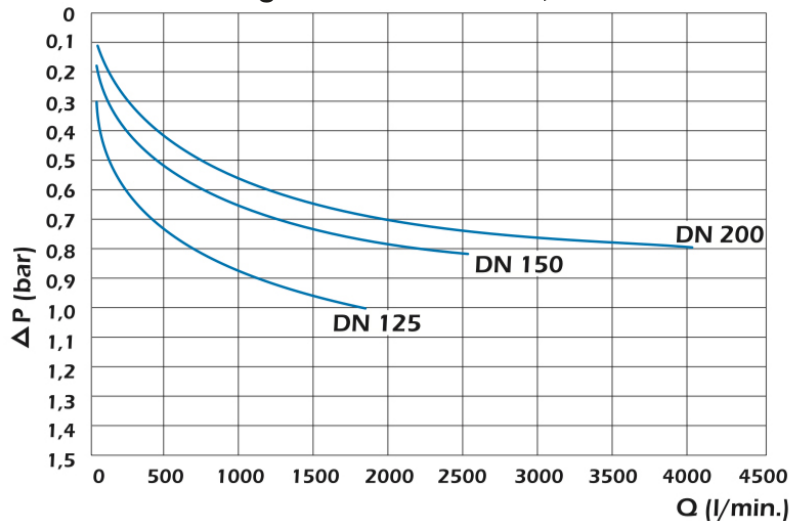

Cavitation

Checking if the differential of pressure, between the upstream and the desired downstream pressure, is not too large is necessary to avoid cavitation risk. By putting in the graph hereafter, the upstream value and the desired downstream pressure, 3 results are possible :

- NO : The point is in the no-cavitation zone, normal duty
- Transitory : The point is in the risk of cavitation zone, the pressure reducing valve can be damaged in case of continuous operation. If the pressure reducing valve is to operate in this zone, contact us.
- Cavitation : The point is in the cavitation zone : continuous operation in this zone can cause rapid damage of the internal parts. The operation in this zone is unauthorized.

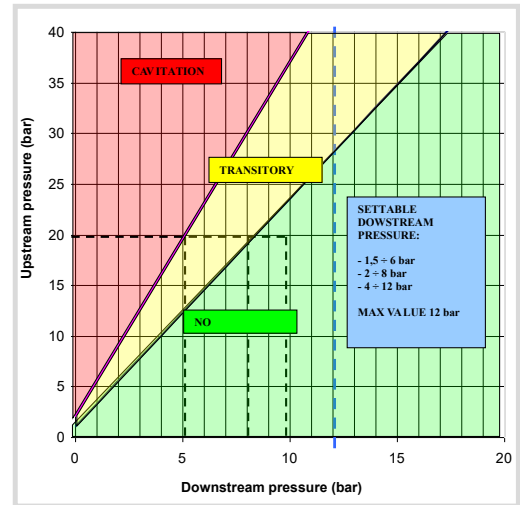

Sizing

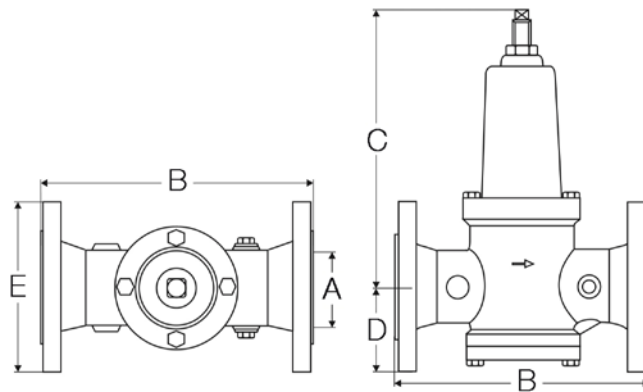

A	DN in mm	50	65	80	100	125	150	200
B	mm	230	290	310	350	400	450	550
C	mm	301	354	390	492	560	670	1050
D	mm	83	92,5	100	121	152	169	234
E PN16	mm	165	185	200	235	250	285	340
E PN25	mm	165	185	200	235	270	300	360
E PN40	mm	165	185	200	235	270	300	-
Weight	kg	15	22	27	37	77	98	191

The descriptions and photographs contained in this product specification sheet are supplied by way of information only and are not binding.

Watts reserves the right to carry out any technical and design improvements to its products without prior notice. Warranty : All sales and contracts for sale are expressly conditioned on the buyer's assent to Watts terms and conditions found on its website at www.wattswater.eu. Watts hereby objects to any term, different from or additional to Socla terms, contained in any buyer communication in any form, unless agreed to in a writing signed by an officer of Watts.



Watts Industries Italia S.r.l.

Via Brenno, 21 • 20853 Biassono (MB) • Italy
 Tel. +39 039 4986.1 • Fax +39 039 4986.222
infowattsitatia@wattswater.com • www.watts.com