

Uitloop DN 150 met geïntegreerde lippen dichting  
 Sortie DN 150 avec joint à lèvres intégré

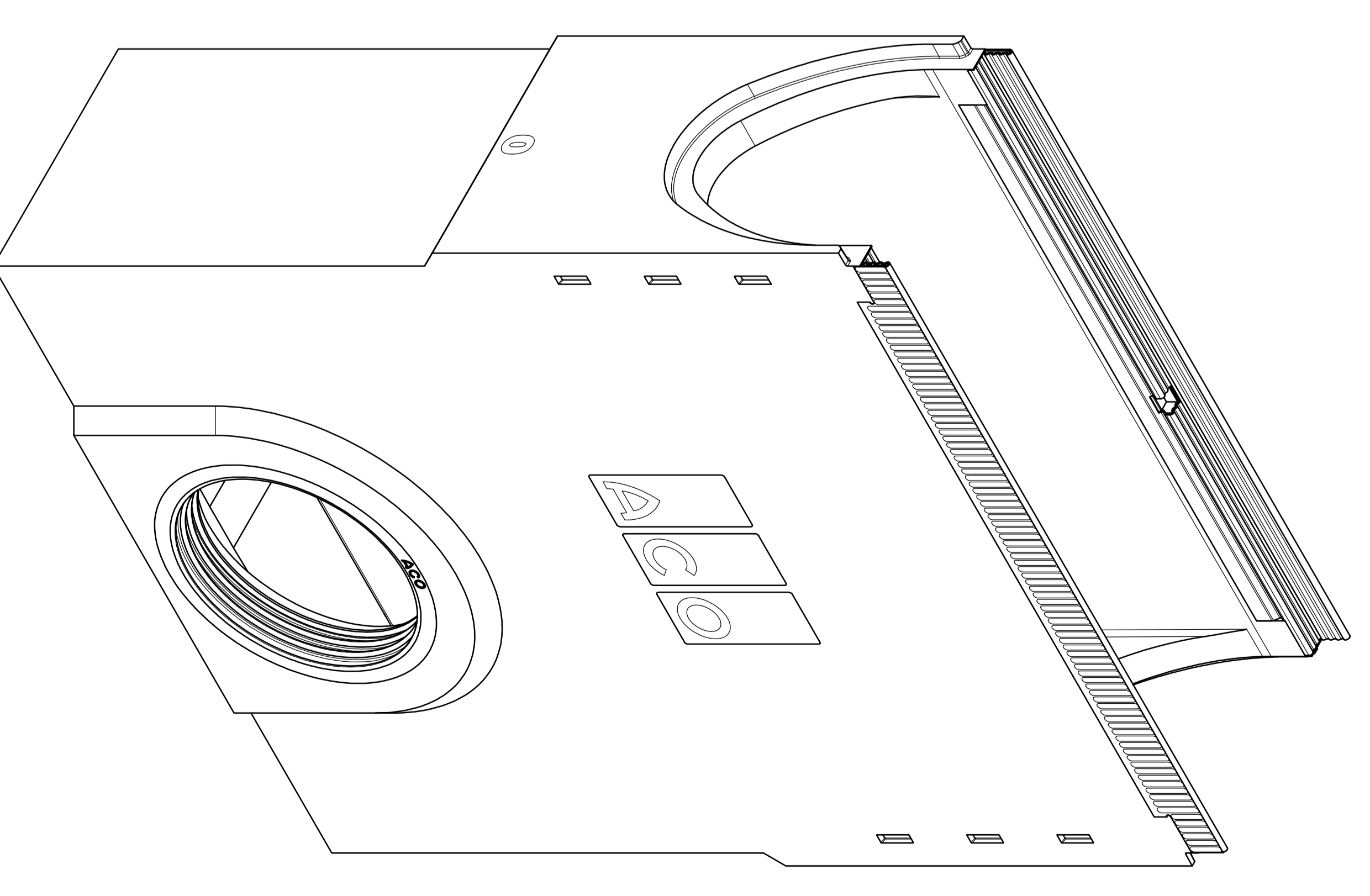

| voor kanaal /<br>pour canal /<br>type | h<br>(mm) | Randbescherming uit / Feuillure en  |                                       |
|---------------------------------------|-----------|-------------------------------------|---------------------------------------|
|                                       |           | Verzinkt staal /<br>Acier galvanisé | Roestvrij staal /<br>Acier inoxydable |
| 0.                                    | 185       | 133391                              | 133491                                |
| 5.                                    | 210       | 133392                              | 133492                                |
| 10.                                   | 235       | 133393                              | 133493                                |
| 20.                                   | 285       | 133394                              | 133494                                |

Multiline V 150 S "Seal in" (0. - 20.)  
 zandvanger  
 met geïntegreerde EPDM-aftichting thv tand/groef  
 désableur  
 avec joint EPDM incorporé à la connexion mâle/fem.  
 belastingsklasse A15 - E600 classe de résistance

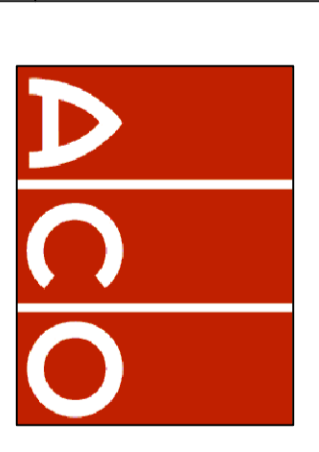

ACO Passavant NV/SA Tel.: 052/38.17.70  
 Preenakker 8 Fax.: 052/38.17.71  
 B - 1785 Merchtem info@aco.be  
 www.aco.be

| Name     | Date     |
|----------|----------|
| By SB    | 10/08/21 |
| Check DA | 10/08/21 |

Artikel-Nr. - N° d'article  
 zie tabel / voir tableau  
 Tekening Nr. - Dessin n°

Technische veranderingen voorbehouden - Sous réserve de changements techniques

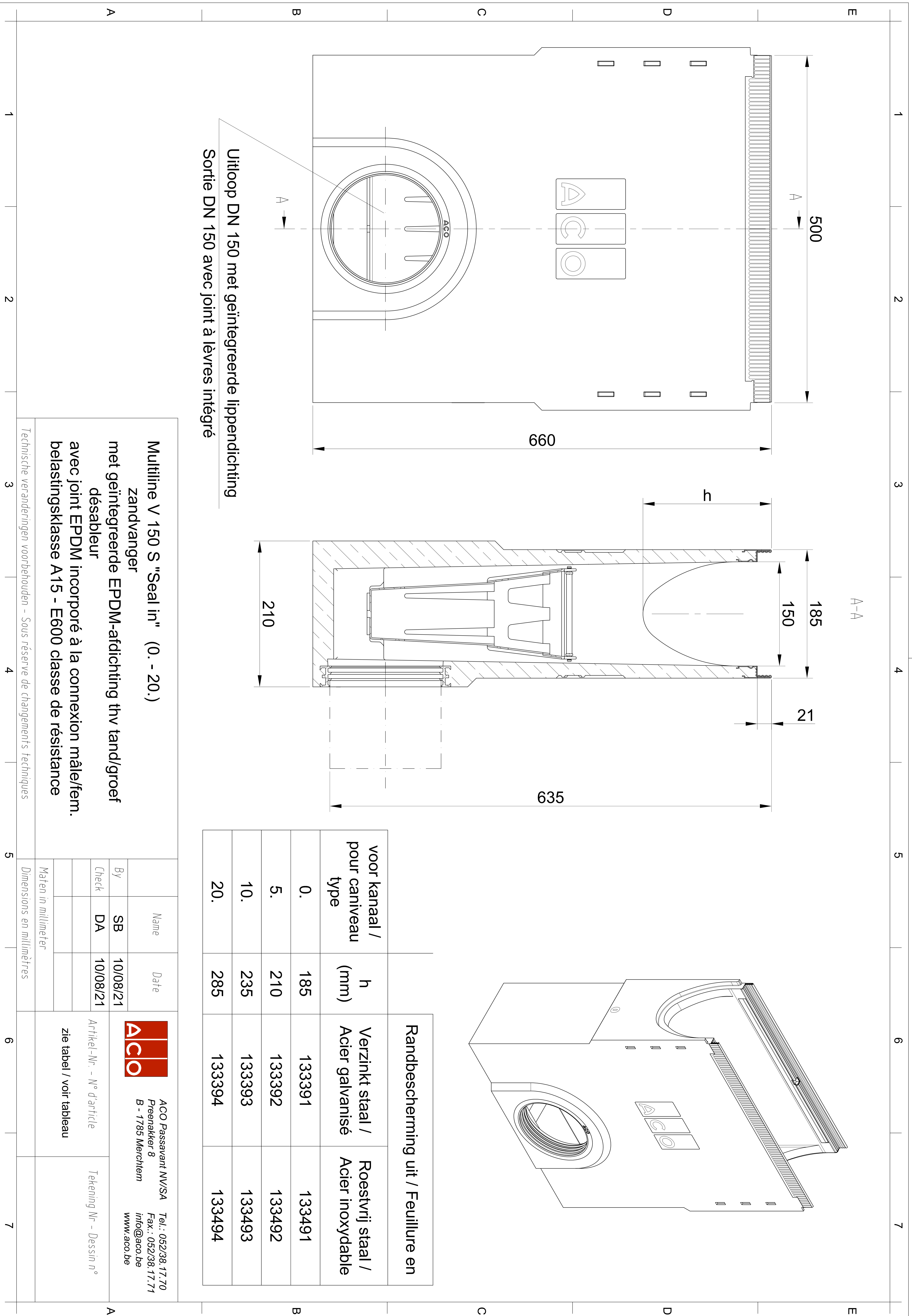

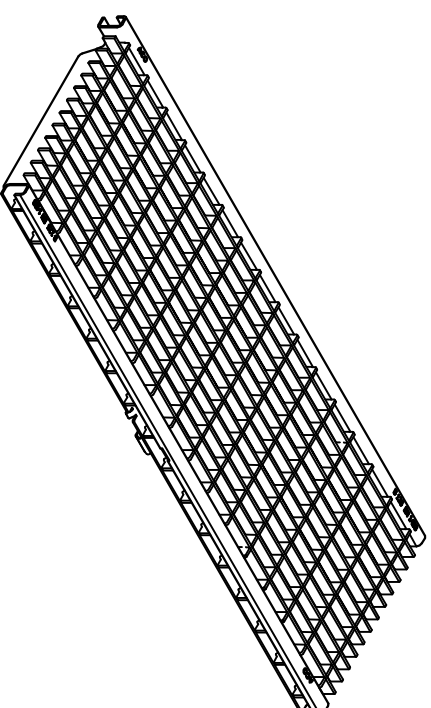
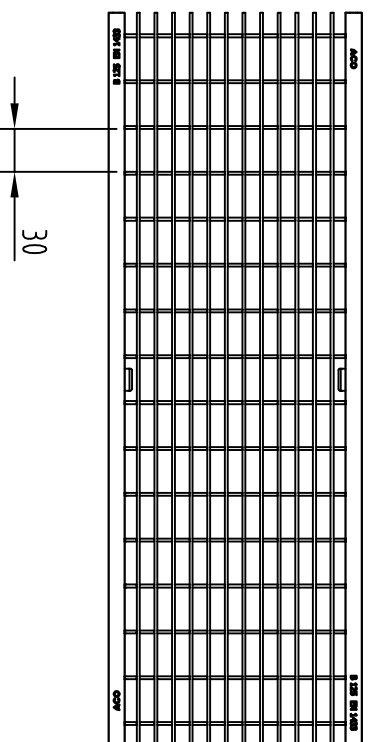
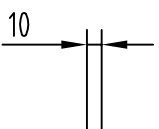
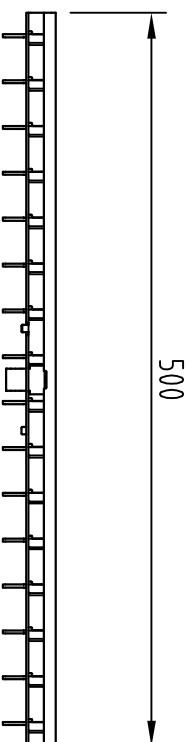
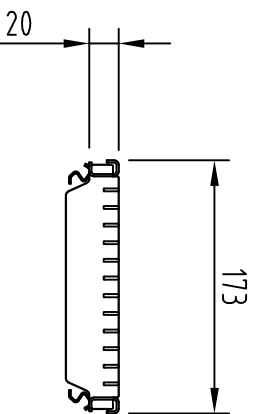
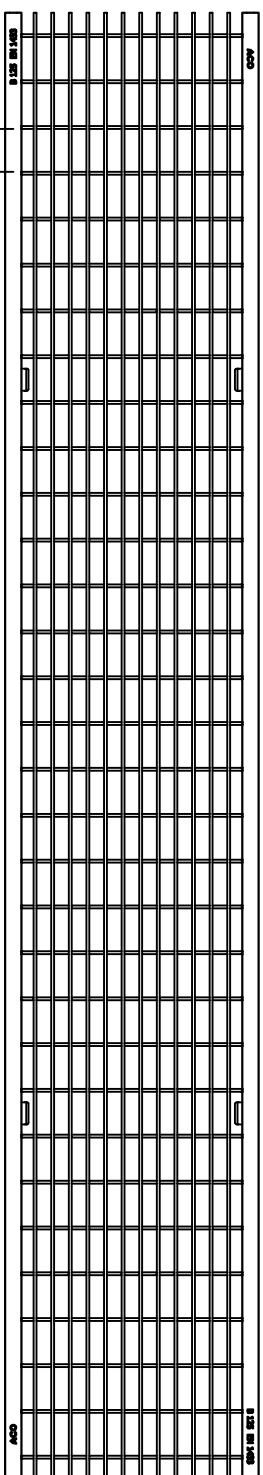
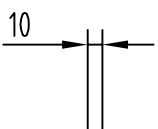
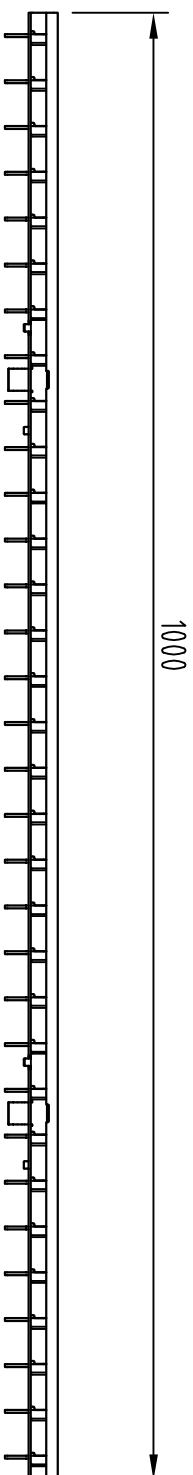
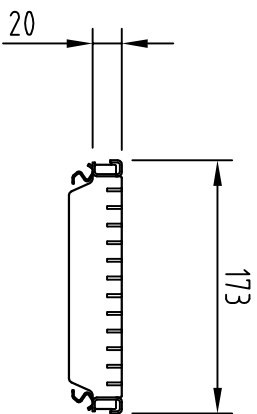

|       |                 |                 |
|-------|-----------------|-----------------|
| Rost  | Stahl verzinkt  | VZA             |
| 1,0 m | Art.-Nr. 133601 | Art.-Nr. 133603 |
| 0,5 m | 133602          | 133604          |

Benennung:  
 ACO DRAIN Multiline V 150 Maschenrost Q+, MW 30x10  
 VZA / Stahl verz., Kl. B125, L= 1,0 m / 0,5 m  
 Art.-Nr. 133601, 133602, 133603, 133604

|            |       |          |
|------------|-------|----------|
| Gez.       | Datum | Name     |
| 09.02.2017 |       | debeling |
| Upr.       |       |          |
| Norm       |       |          |

|   |  |                                |              |
|---|--|--------------------------------|--------------|
| ACO Tiefbau Vertrieb GmbH<br>24755 Bending, Postfach 209<br>Tel. 04331 / 351-500<br>FAX 04331 / 351-539<br>www.aco-tiefbau.de |  | Zeichnung-Nr.<br>G1-M01-1563-3 | Index<br>000 |
| Schutzvermerk gemäß DIN 34  |  | Ers. für:                      |              |

Technische Änderungen vorbehalten

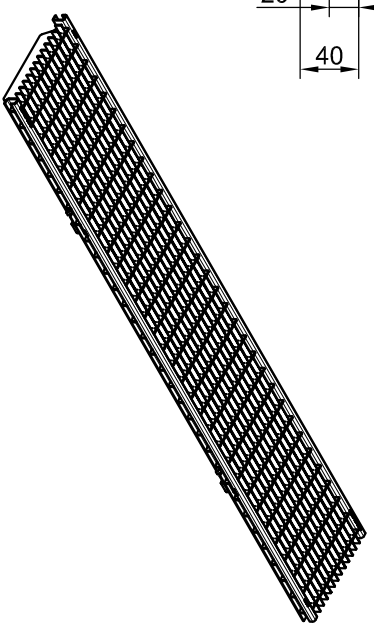
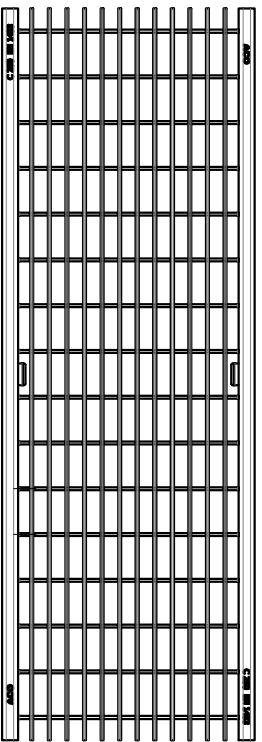
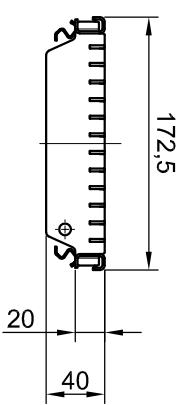
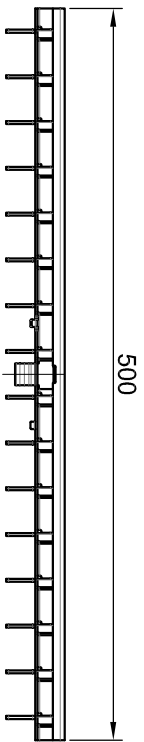
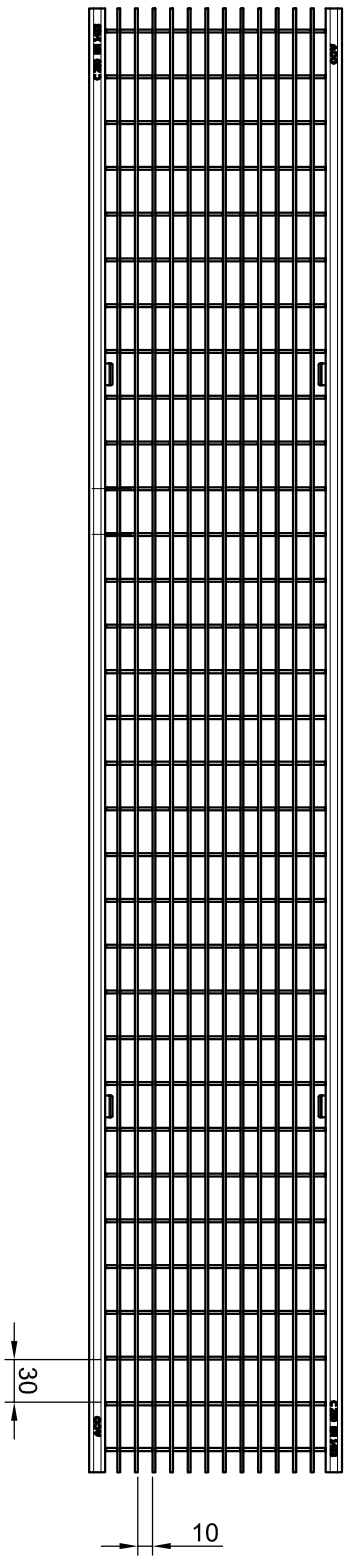
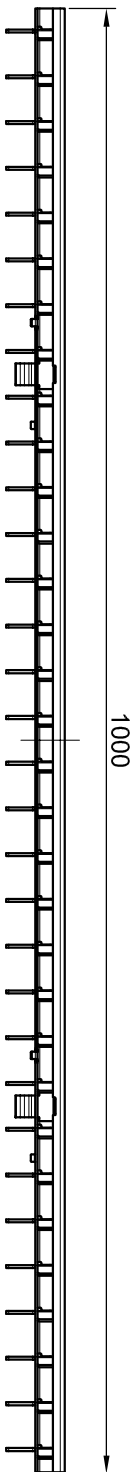

Inloopdoorsnede /  
absorption: 1182 cm<sup>2</sup>/m

|  |  |                            |  |   |  |   |  |   |
|--|--|----------------------------|--|---|--|---|--|---|
| <b>Naam - Nom</b><br><b>Multiline V 150</b><br>Q+ maastrooster uit verzinkt staal kl. C 250 KN<br>(mazen / mailles 30x10 mm)<br>Q+ grille caillabois en acier galvanisé cl. C 250 KN |  | <b>Name</b><br>SB<br>TS    |  | <b>Date</b><br>20/09/17<br>20/09/17                                 |  |  | ACO Passavant NV/SA<br>Peenrikker 8<br>B - 1785 Merchtem | Tel.: 052/38.17.70<br>Fax.: 052/38.17.71<br>info@aco.be<br>www.aco.be |
| <b>Technische veranderingen voorbehouden - Sous réserve de changements techniques</b>  |  | <b>Maten in millimeter</b> |  | <b>Artikel-Nr. - N° d'article</b><br>133605 (1 m)<br>133606 (0,5 m) |  |   |  |   |

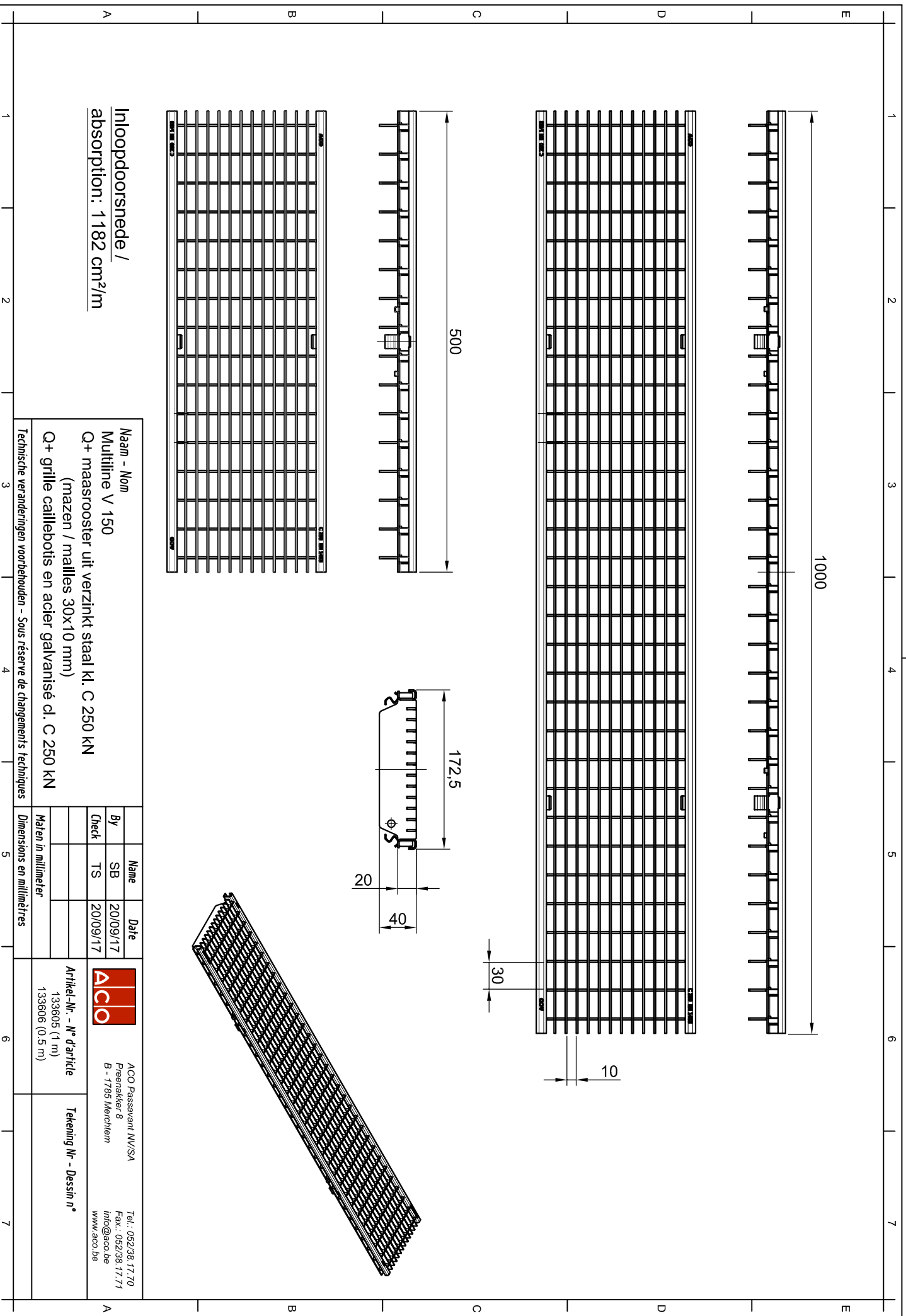

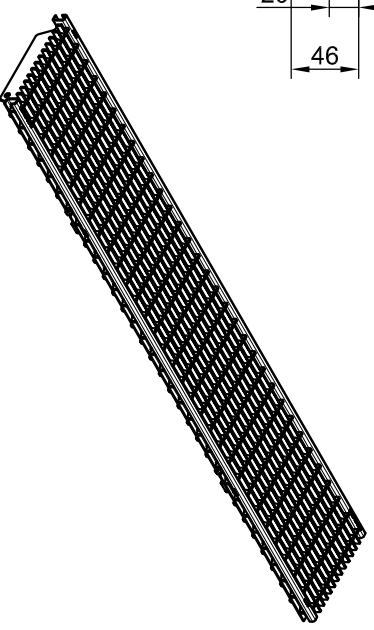
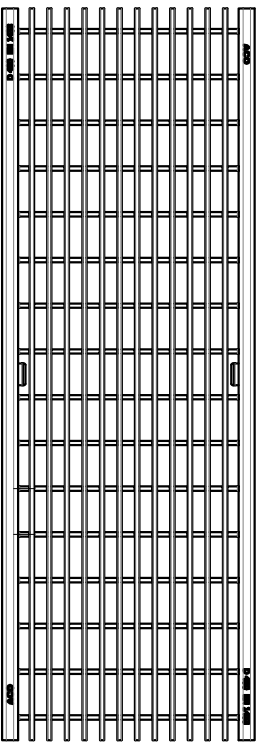
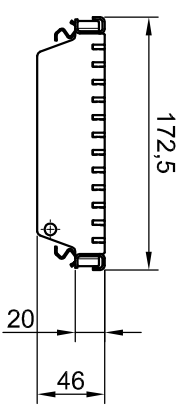
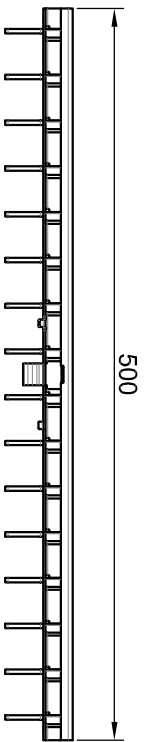
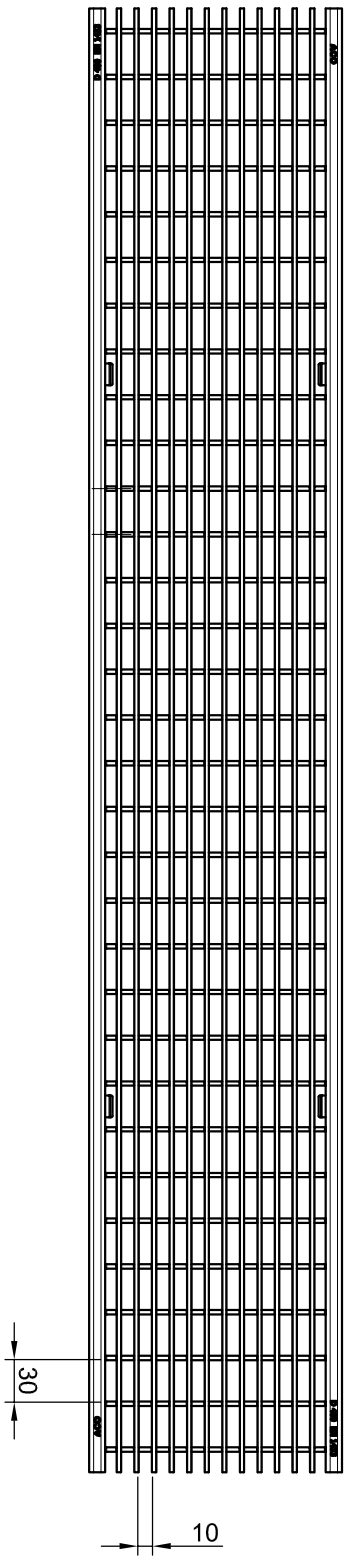
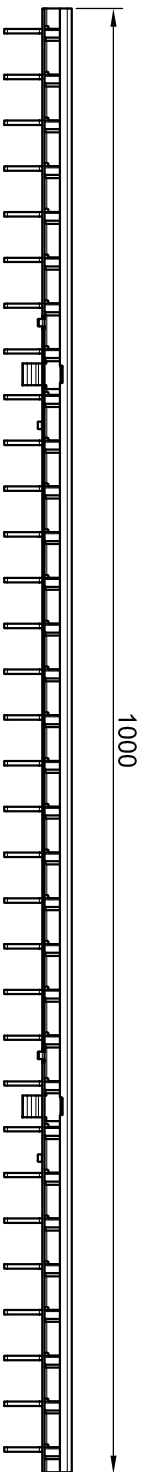

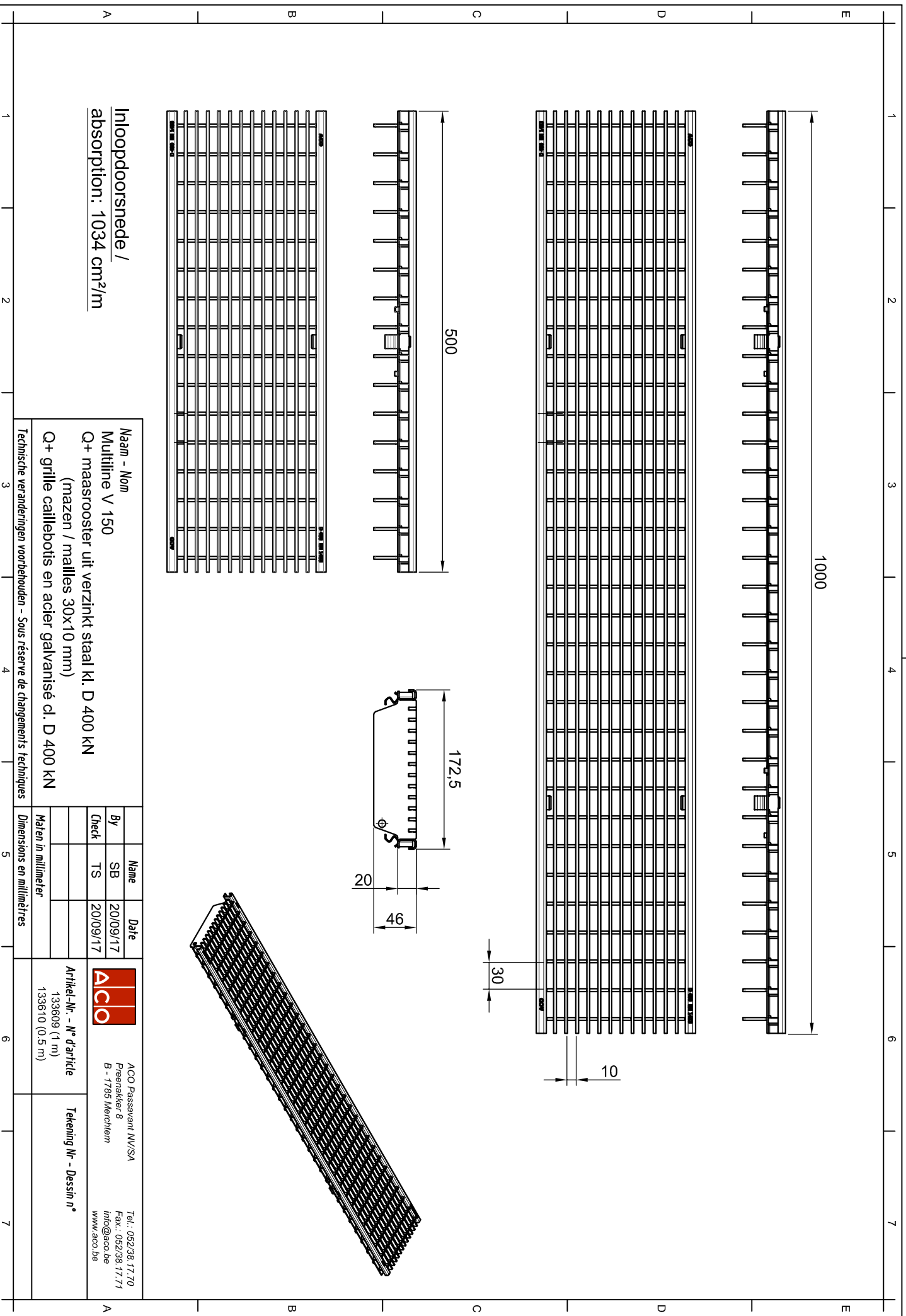

Inloopdoorsnede /  
absorption: 1034 cm<sup>2</sup>/m

|  |  |                            |  |                                     |  |   |  |  |
|--|--|----------------------------|--|-------------------------------------|--|---|--|--|
| <b>Naam - Nom</b><br><b>Multiline V 150</b><br><b>Q+ maastrooster uit verzinkt staal kl. D 400 KN</b><br>(mazen / mailles 30x10 mm)<br><b>Q+ grille caillabois en acier galvanisé cl. D 400 KN</b> |  | <b>Name</b><br>SB<br>TS    |  | <b>Date</b><br>20/09/17<br>20/09/17 |  |  | ACO Passavant NV/SA<br>Peenakker 8<br>B - 1785 Merchtem<br>info@aco.be<br>www.aco.be | <b>Tekening Nr - Dessin n°</b><br>133609 (1 m)<br>133610 (0,5 m) |
| <b>Technische veranderingen voorbehouden - Sous réserve de changements techniques</b>  |  | <b>Maten in millimeter</b> |  | <b>Dimensions en millimètres</b>    |  |   |  |  |

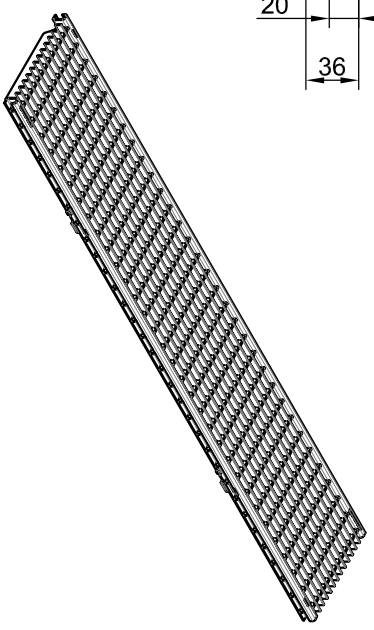
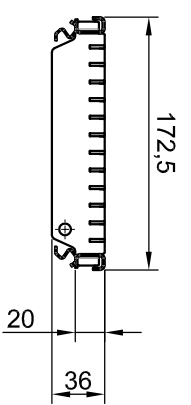
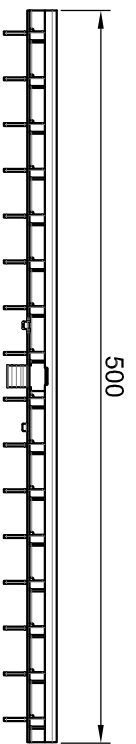
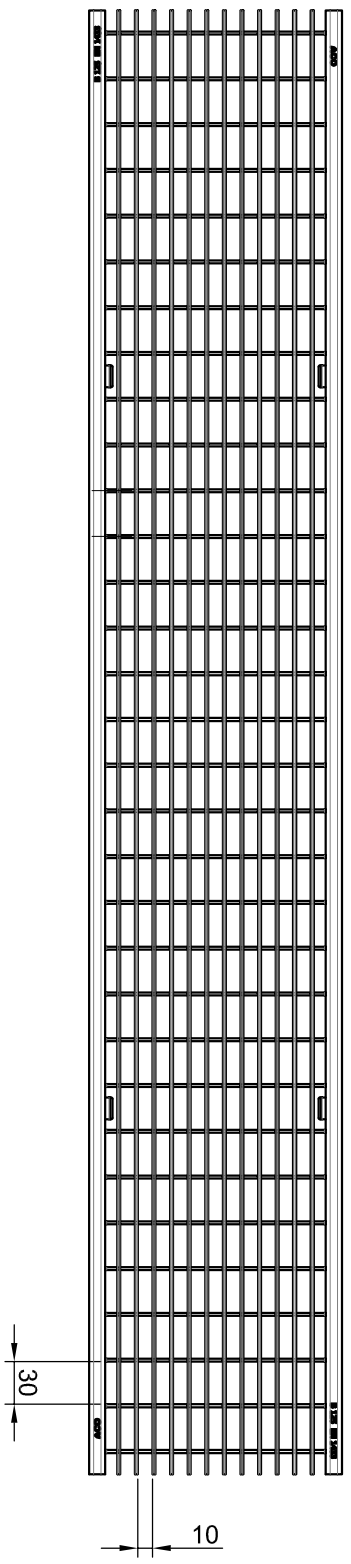
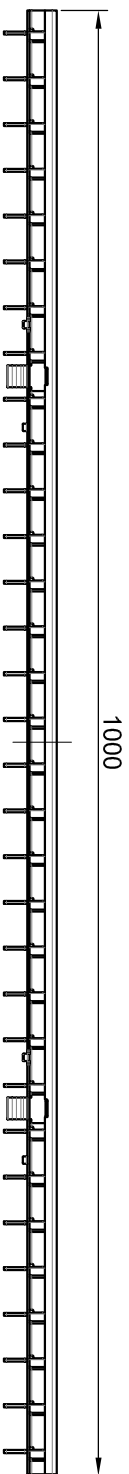



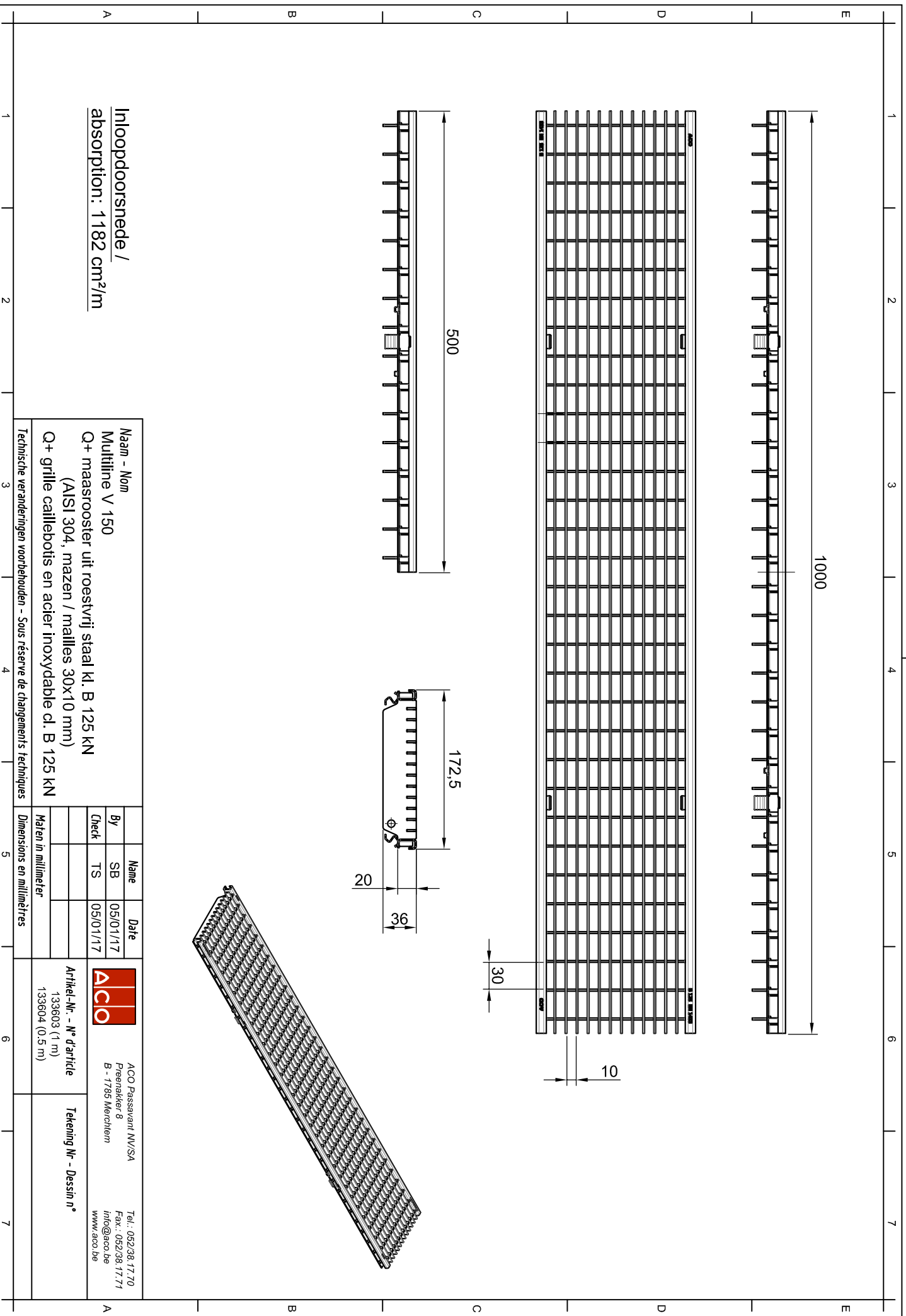

Inloopdoorsnede /  
absorption: 1182 cm<sup>2</sup>/m

|  |  |                            |  |   |  |   |   |
|--|--|----------------------------|--|---|--|---|---|
| <b>Naam - Nom</b><br>Multiline V 150<br>Q+ maastrooster uit roestvrij staal kl. B 125 kN<br>(AISI 304, mazen / mailles 30x10 mm)<br>Q+ grille caillaboits en acier inoxydable cl. B 125 kN |  | <b>Name</b><br>SB<br>TS    |  | <b>Date</b><br>05/01/17<br>05/01/17                                 |  |  | ACO Passavant NV/SA<br>Peenakker 8<br>B - 1785 Merchtem<br>Tel.: 052/38.17.70<br>Fax: 052/38.17.71<br>info@aco.be<br>www.aco.be |
| <b>Technische veranderingen voorbehouden - Sous réserve de changements techniques</b>  |  | <b>Maten in millimeter</b> |  | <b>Artikel-Nr. - N° d'article</b><br>133603 (1 m)<br>133604 (0,5 m) |  |   |   |

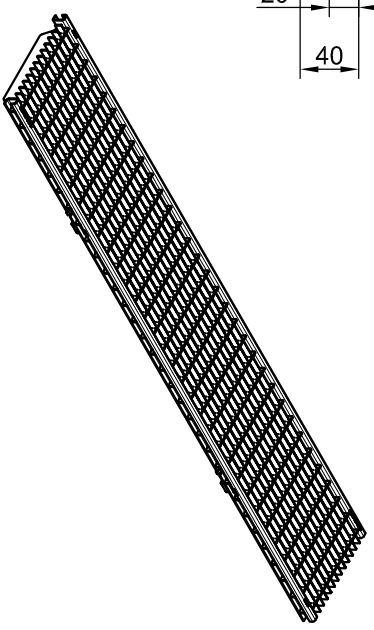
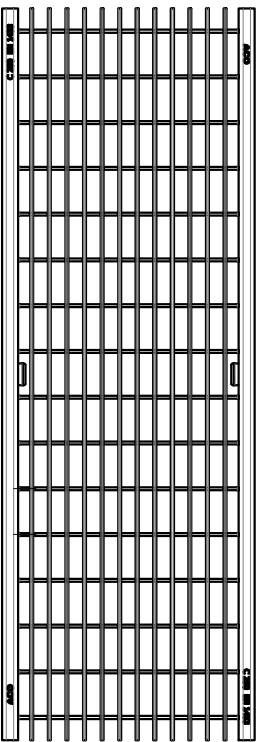
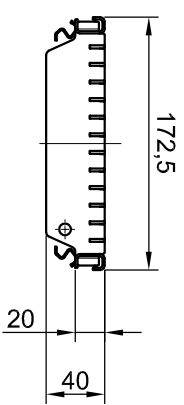
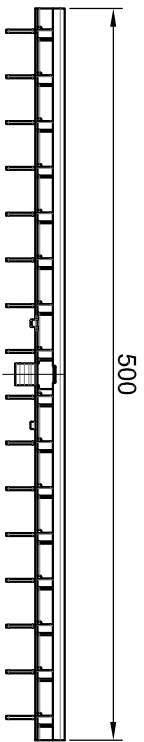
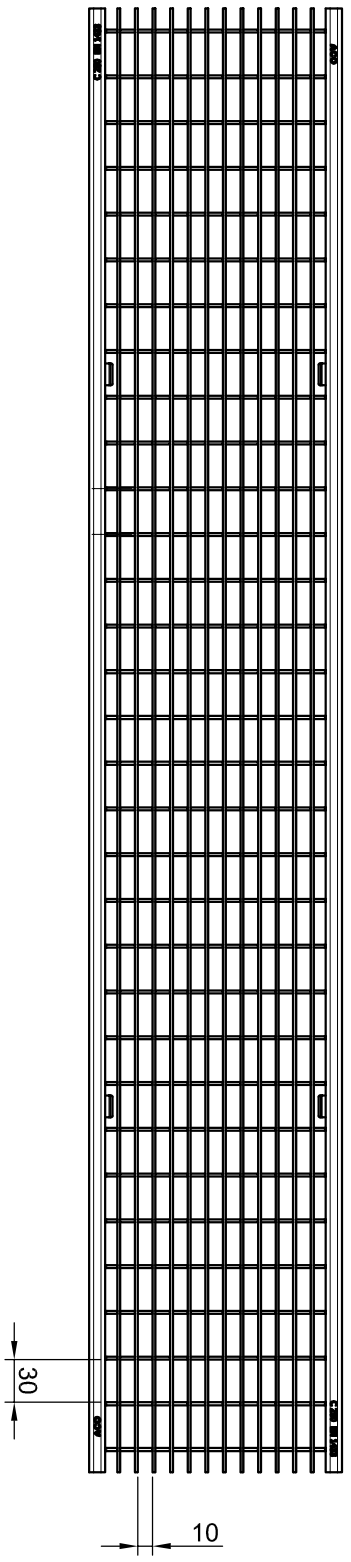
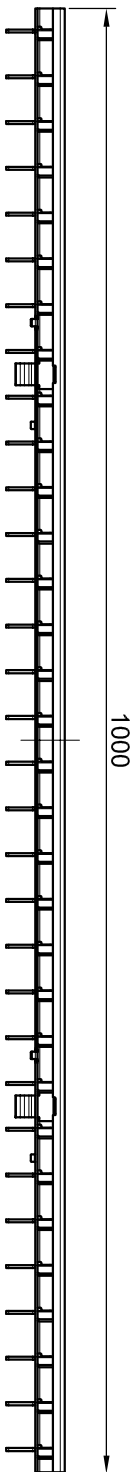



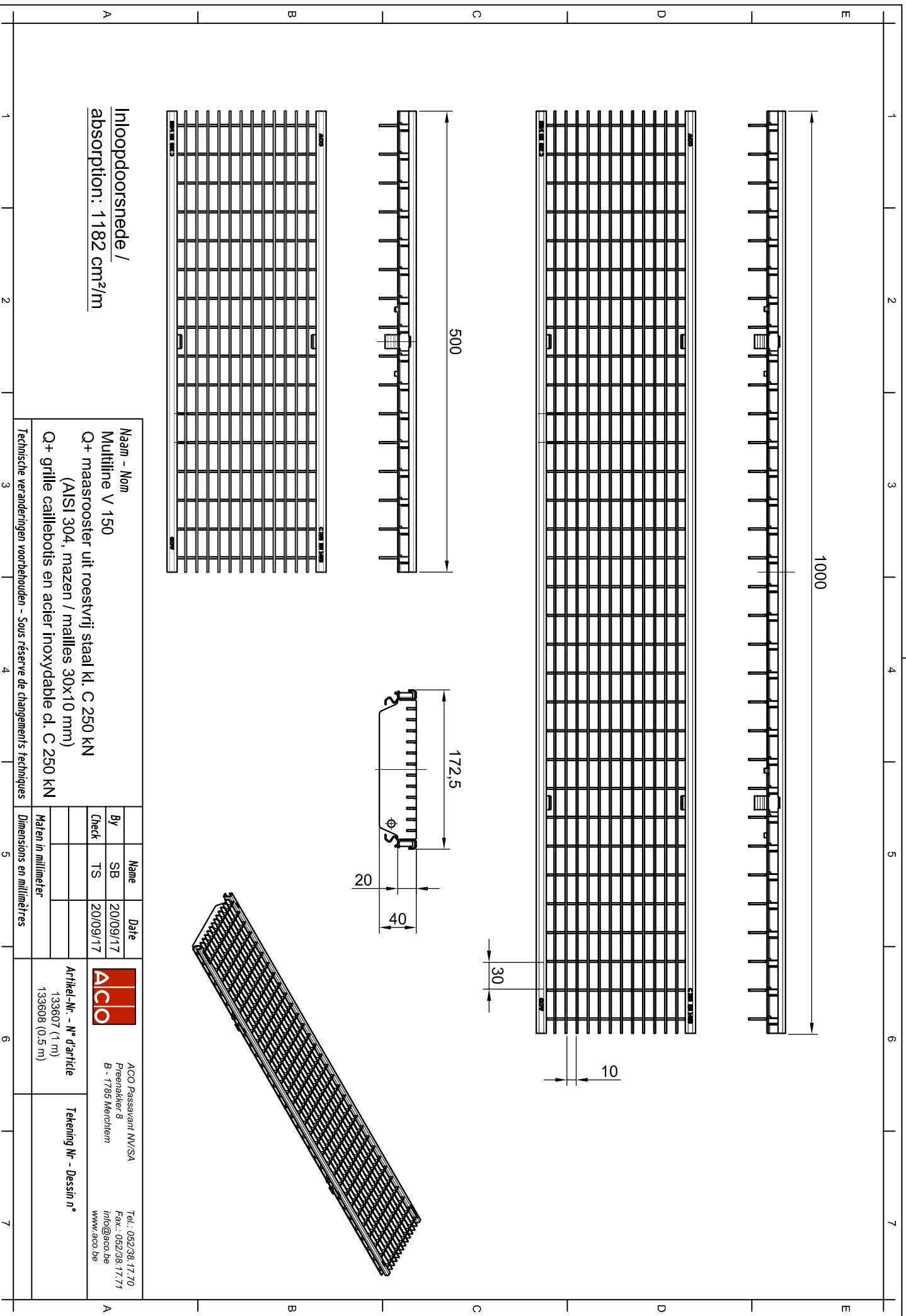

Inloopdoorsnede /  
absorption: 1182 cm<sup>2</sup>/m

|  |  |                            |  |   |  |   |  |   |
|--|--|----------------------------|--|---|--|---|--|---|
| <b>Naam - Nom</b><br>Multiline V 150<br>Q+ maasrooster uit roestvrij staal kl. C 250 kN<br>(AISI 304, mazen / mailles 30x10 mm)<br>Q+ grille caillabois en acier inoxydable cl. C 250 kN |  | <b>Name</b><br>SB<br>TS    |  | <b>Date</b><br>20/09/17<br>20/09/17                                 |  |  | ACO Passavant NV/SA<br>Peenrikker 8<br>B - 1785 Merchtem | Tel.: 052/38.17.70<br>Fax.: 052/38.17.71<br>info@aco.be<br>www.aco.be |
| <b>Technische veranderingen voorbehouden - Sous réserve de changements techniques</b>  |  | <b>Maten in millimeter</b> |  | <b>Artikel-Nr. - N° d'article</b><br>133607 (1 m)<br>133608 (0,5 m) |  |   |  |   |

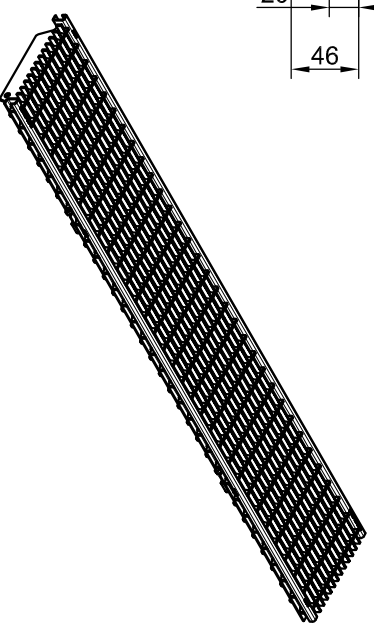
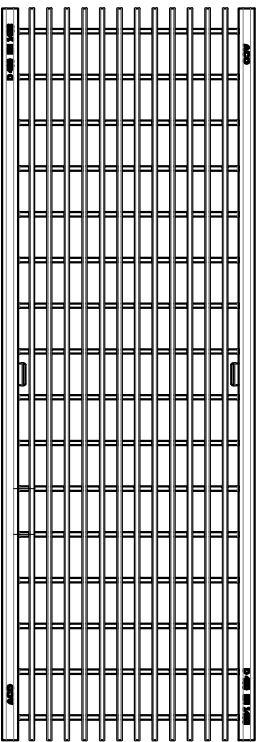
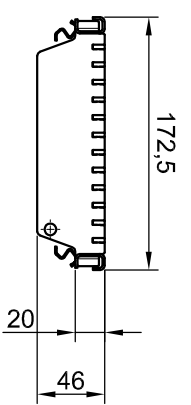
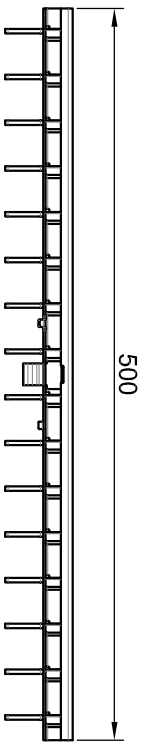
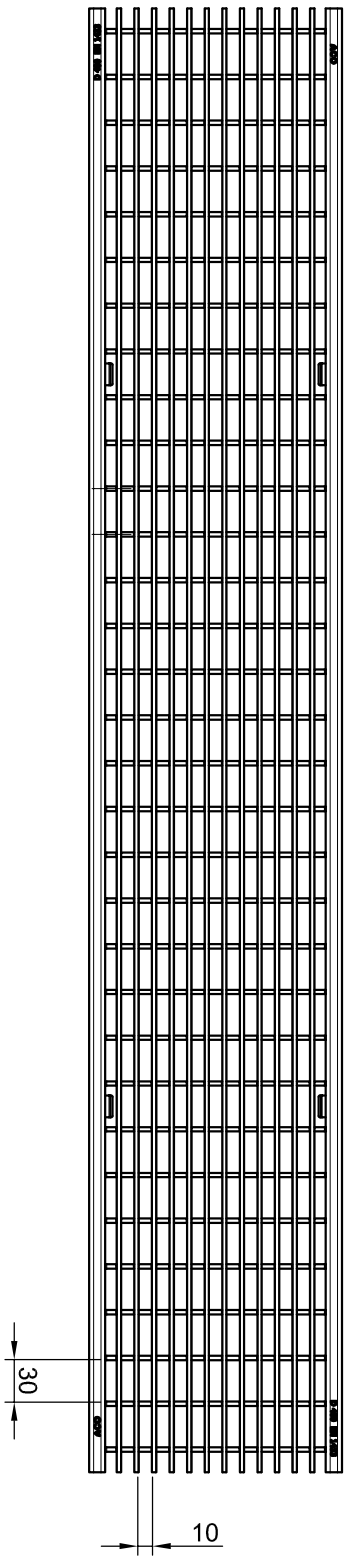
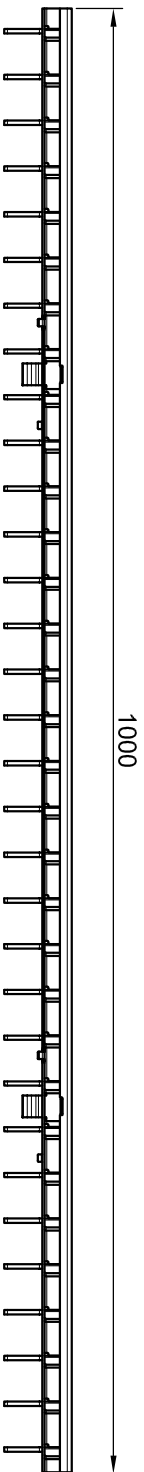



Inloopdoorsnede /  
absorption: 1034 cm<sup>2</sup>/m

|  |  |                            |  |                                     |  |   |  |  |
|--|--|----------------------------|--|-------------------------------------|--|---|--|--|
| <b>Naam - Nom</b><br>Multiline V 150<br>Q+ maastrooster uit roestvrij staal kl. D 400 kN<br>(AISI 304, mazen / mailles 30x10 mm)<br>Q+ grille caillaboits en acier inoxydable cl. D 400 kN |  | <b>Name</b><br>SB<br>TS    |  | <b>Date</b><br>30/08/17<br>30/08/17 |  |  | ACO Passavant NV/SA<br>Peenakker 8<br>B - 1785 Merchtem<br>info@aco.be<br>www.aco.be | <b>Tekening Nr - Dessin n°</b><br>133611 (1 m)<br>133612 (0,5 m) |
| <b>Technische veranderingen voorbehouden - Sous réserve de changements techniques</b>  |  | <b>Maten in millimeter</b> |  | <b>Dimensions en millimètres</b>    |  |   |  |  |

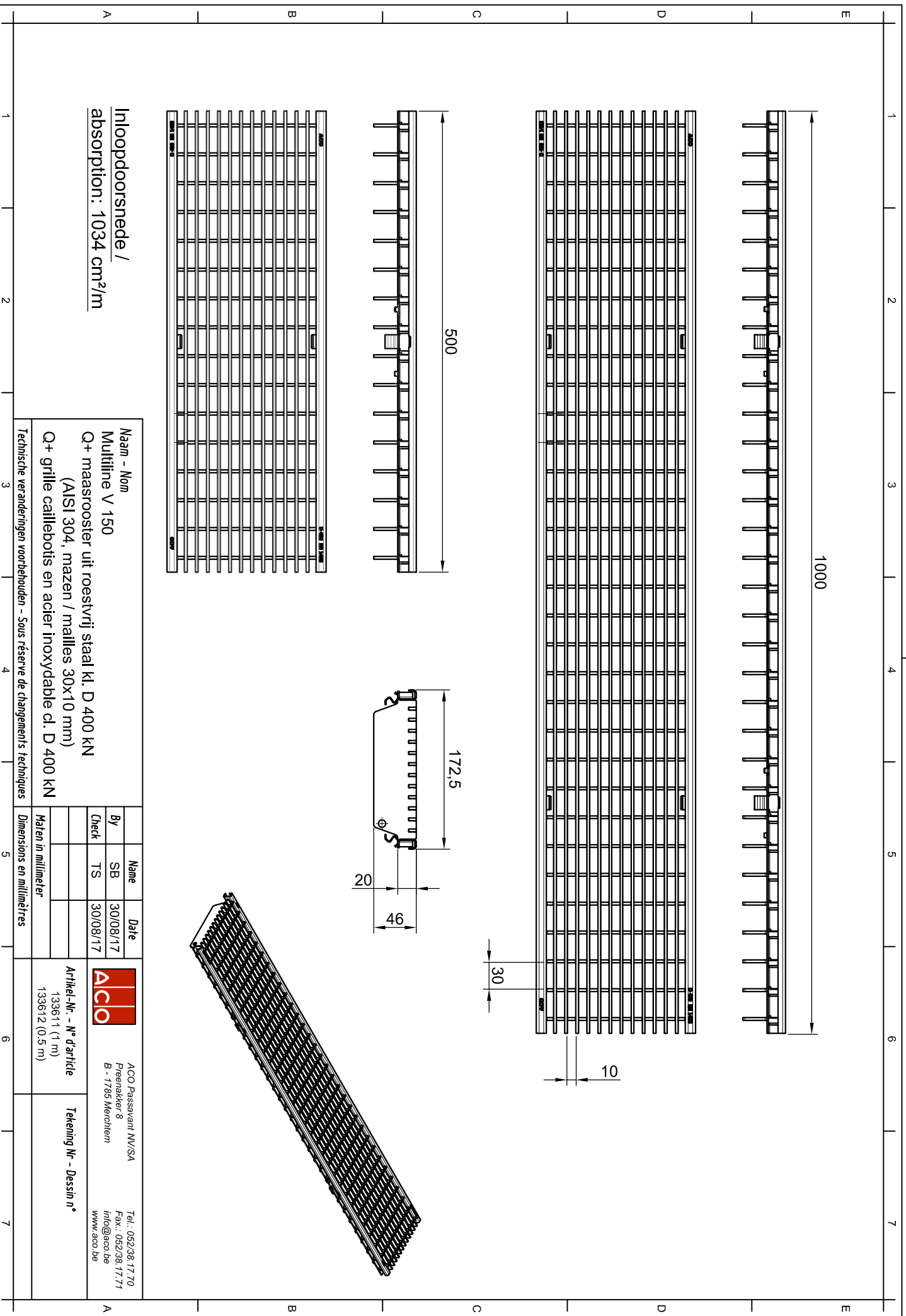

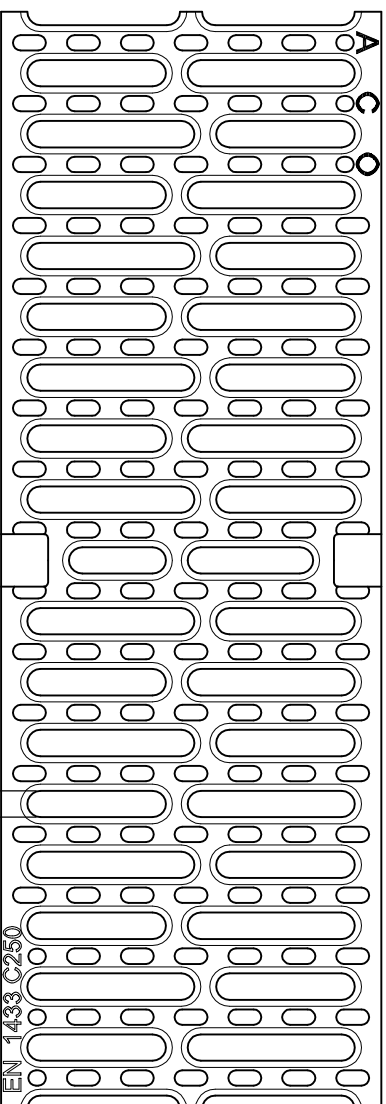
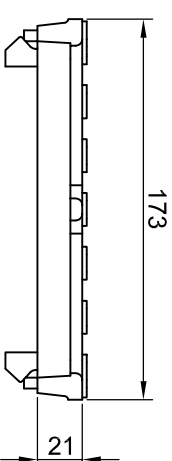
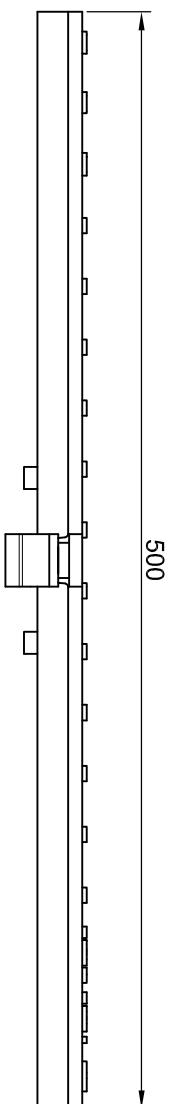

Inloopdoorsnede /  
absorption: 578 cm<sup>2</sup>/m

**Naam - Nom**  
Multiiline V 150  
sleufrooster uit gietijzer kl. C 250 KN  
grille passerelle en fonte cl. C 250 KN

*Technische veranderingen voorbehouden - Sous réserve de changements techniques*

| Maten in millimeter        |      | Dimensions en millimètres |  |
|----------------------------|------|---------------------------|--|
| By                         | Name | Date                      | <br>ACO Passavant NV/SA<br>Peenakker 8<br>B - 1785 Merchtem<br>Tel.: 052/38.17.70<br>Fax: 052/38.17.71<br>info@aco.be<br>www.aco.be |
| Check                      | SB   | 18/07/12                  |  |
|                            | SW   | 18/07/12                  |  |
| Artikel-Nr. - N° d'article |      | Tekening Nr - Dessin n°   |  |
| 13070                      |      |                           |  |



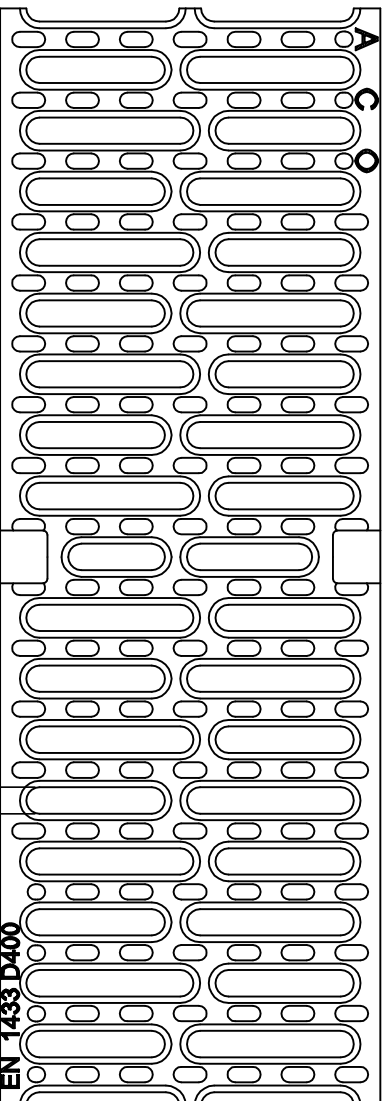
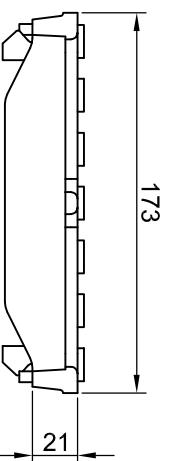
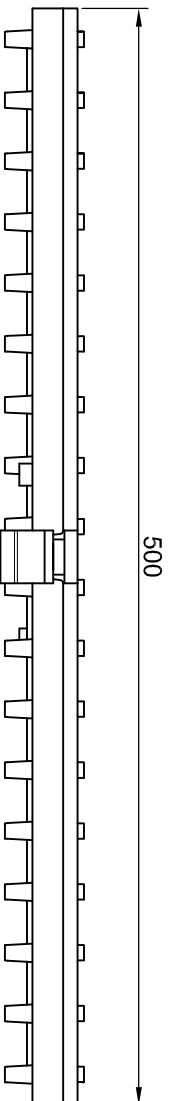

Inlooppdoorsnede /  
absorption: 578 cm<sup>2</sup>/m

**Naam - Nom**  
Multiiline V 150  
sleufrooster uit gietijzer klasse D 400 KN  
grille passerelle en fonte classe D 400 KN

| By    | Name | Date     |
|-------|------|----------|
| SB    | SB   | 12/02/18 |
| Check | SW   | 12/02/18 |

Maten in millimeter



ACO Passavant NV/SA  
Peebikker 8  
B - 1785 Merchtem

Tel.: 052/38.17.70  
Fax.: 052/38.17.71  
info@aco.be  
www.aco.be

Artikel-Nr. - N° d'article  
23164

Tekening Nr - Dessin n°

Technische veranderingen voorbehouden - Sous réserve de changements techniques

Dimensions en millimètres

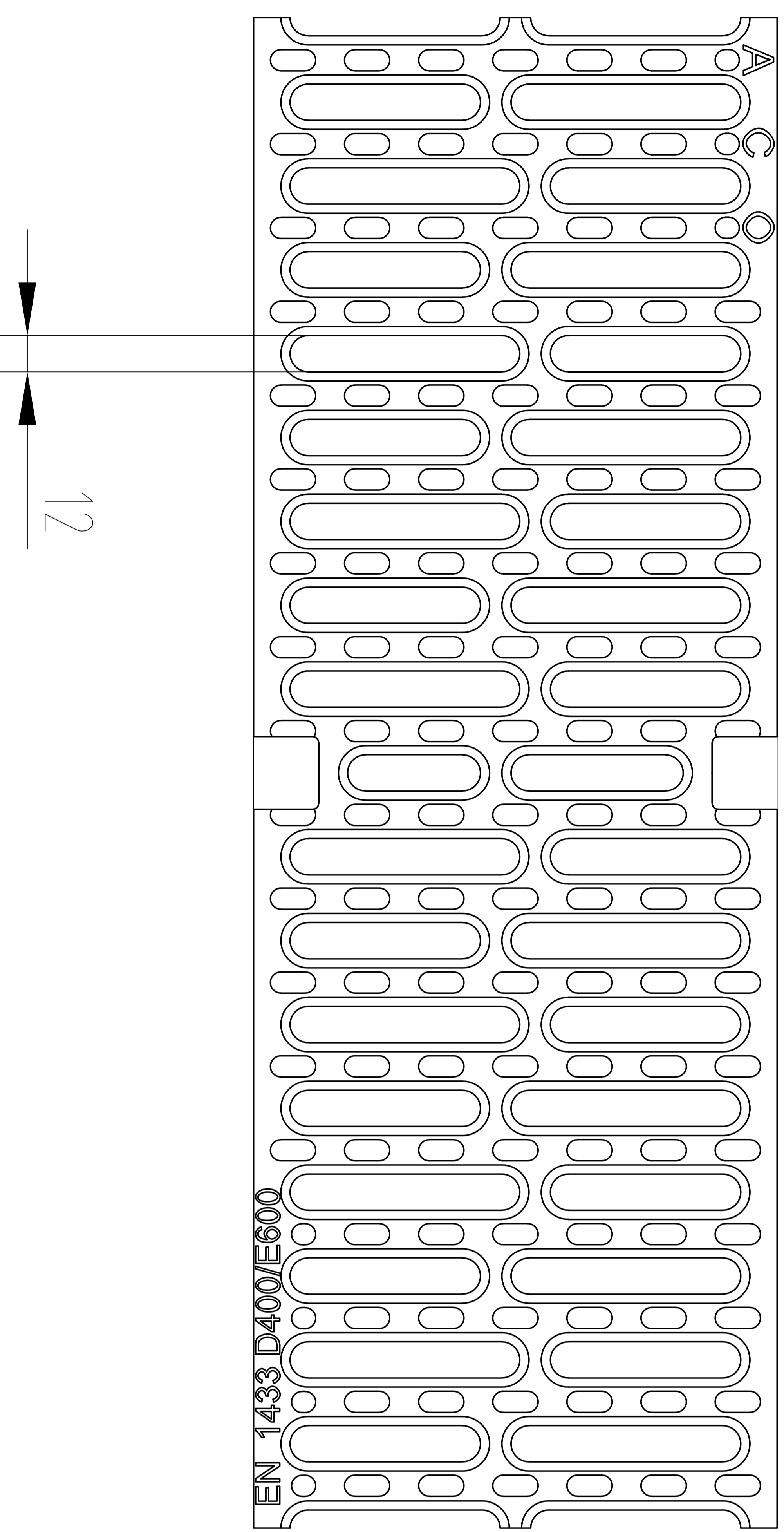
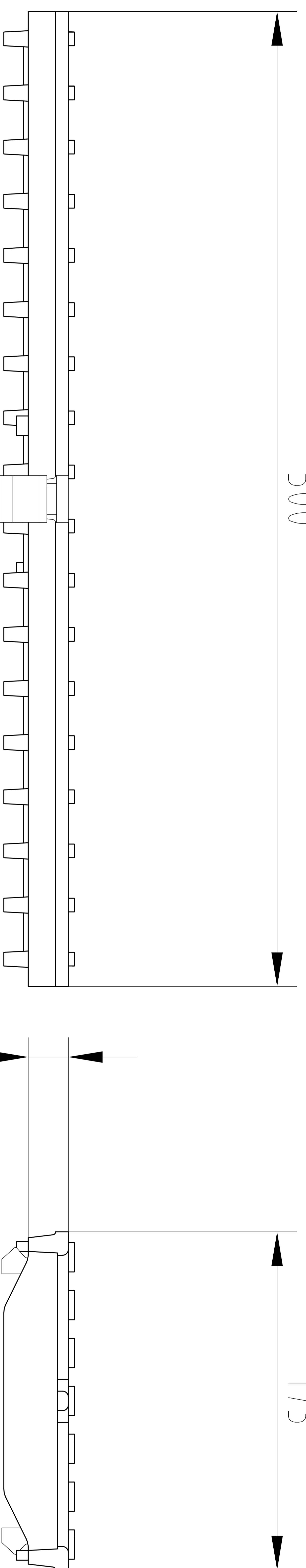

Inloopdoorsnede /  
absorption: 578 cm<sup>2</sup>/m

Multiline V 150  
sleufrooster uit gietijzer kl. E 600 KN  
grille passerelle en fonte cl. E 600 KN

Naam - Norm

|       |      |          |
|-------|------|----------|
| By    | Name | Date     |
| Check | TS   | 30/11/21 |

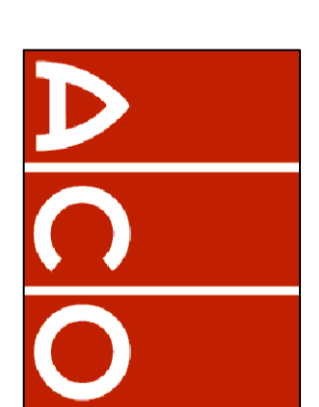

ACO Passavant NV/SA  
Preenakker 8  
B - 1785 Merchtem  
Tel.: 052/38.17.70  
Fax.: 052/38.17.71  
info@aco.be  
www.aco.be

|                     |  |
|---------------------|--|
| Maten in millimeter |  |
|                     |  |

Artikel-Nr. - N° d'article  
133660

Tekening Nr. - Dessin n°

Technische veranderingen voorbehouden - Sous réserve de changements techniques

Dimensions en millimètres

1 2 3 4 5 6 7

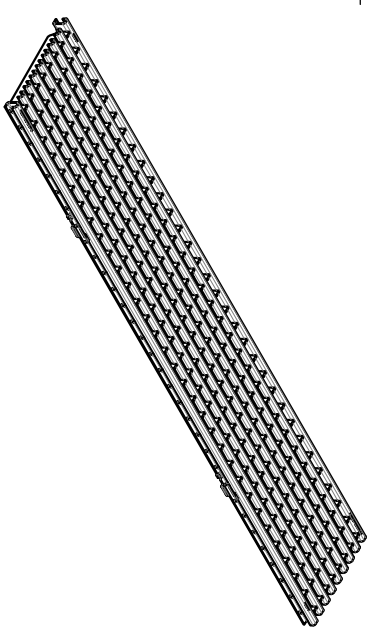
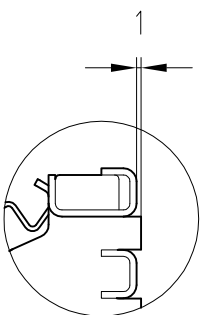
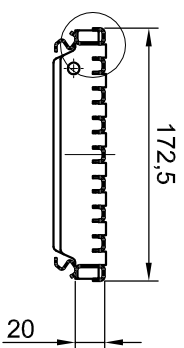
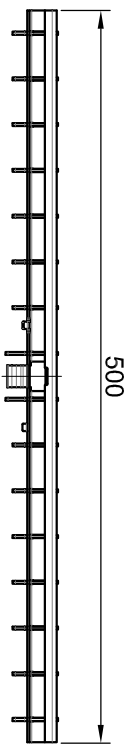
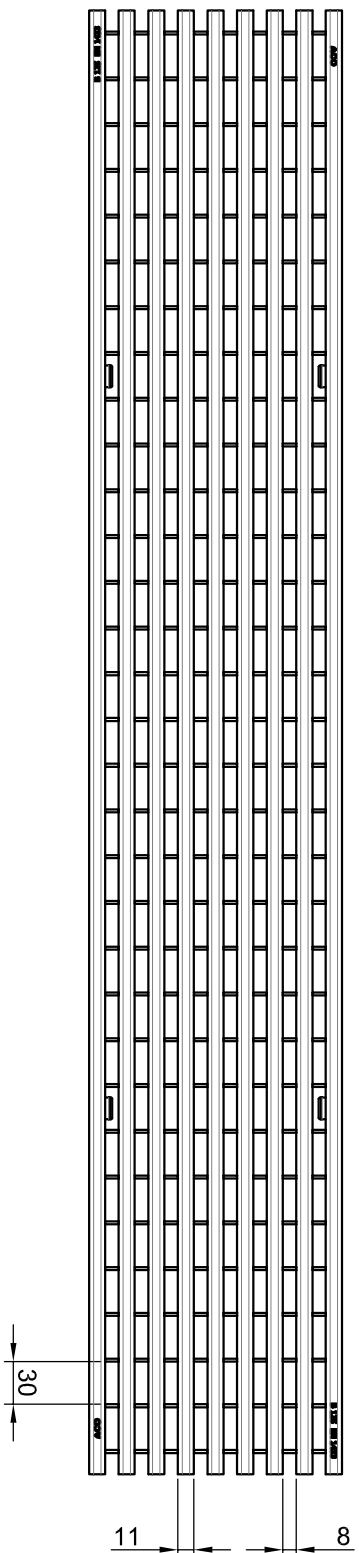
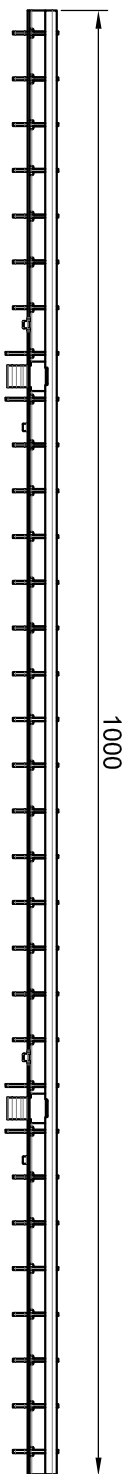

Inloopdoorsnede /  
absorption: 687 cm<sup>2</sup>/m

**Naam - Nom**  
Multiline V 150  
lengtestaafrooster uit verzinkt staal  
B 125 kN - profiel U profiel 8 mm  
grille passerelles longitudinales en acier galvanisé

*Technische veranderingen voorbehouden - Sous réserve de changements techniques*

| Name     | Date     |
|----------|----------|
| By SB    | 05/01/17 |
| Check TS | 05/01/17 |



ACO Passavant NV/SA  
Peeenikker 8  
B - 1785 Merchtem  
Tel.: 052/38.17.70  
Fax: 052/38.17.71  
info@aco.be  
www.aco.be

| Maten in millimeter |  |
|---------------------|--|
|                     |  |
|                     |  |
|                     |  |

Artikel-Nr. - N° d'article  
133625 (1 m)  
133626 (0,5 m)

Tekening Nr - Dessin n°

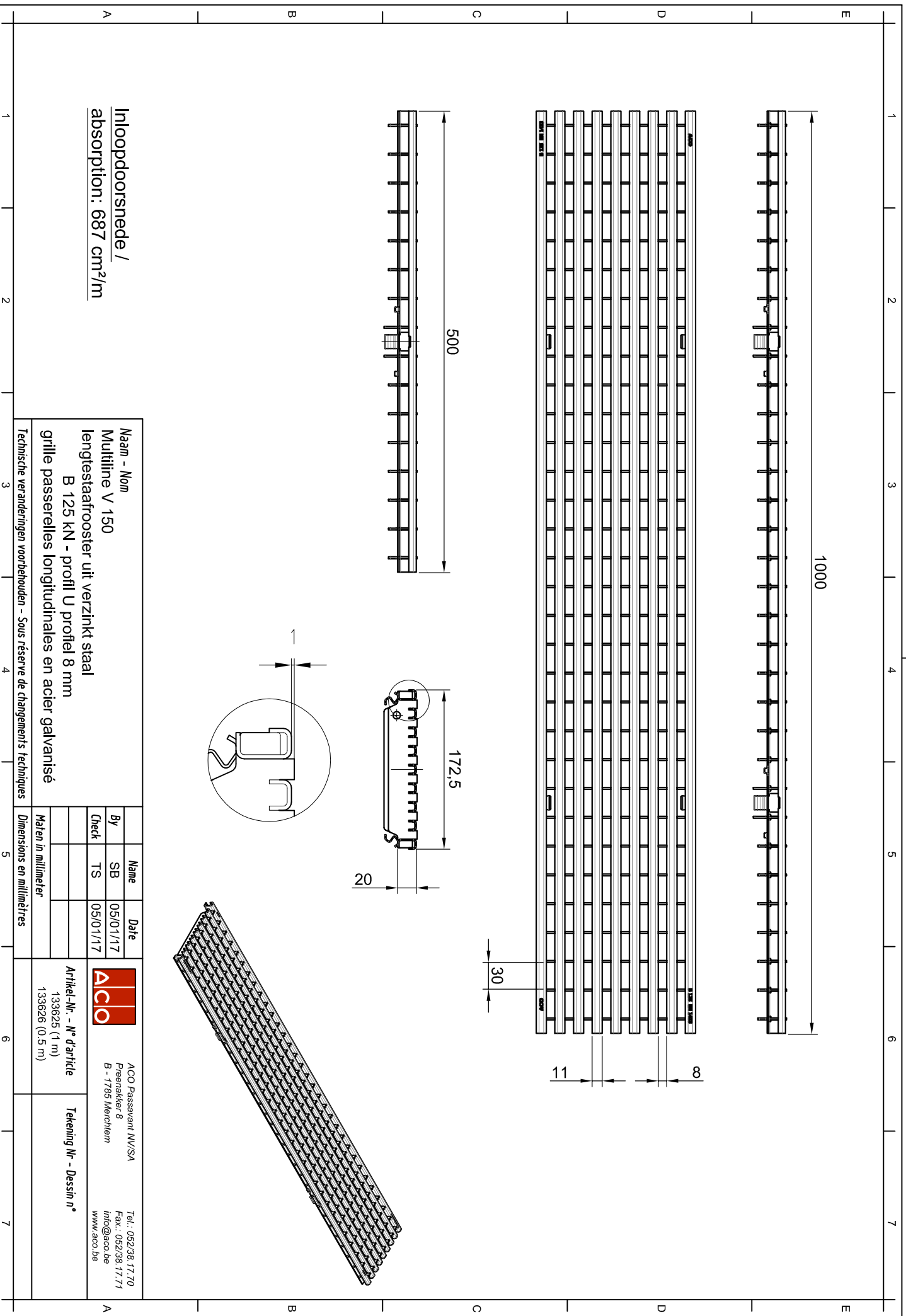

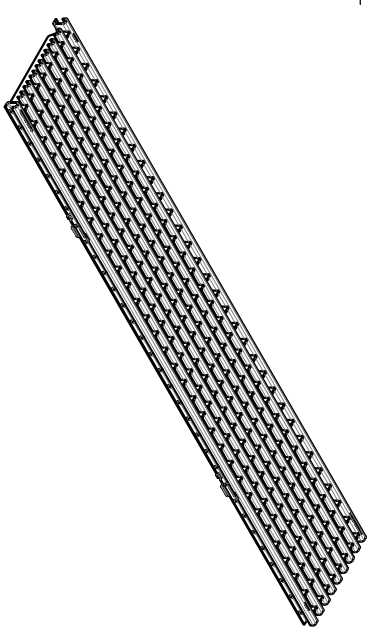
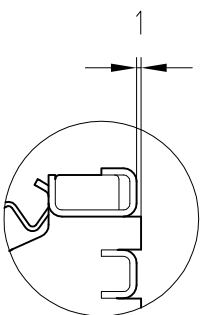
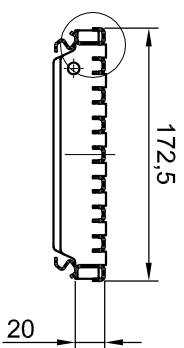
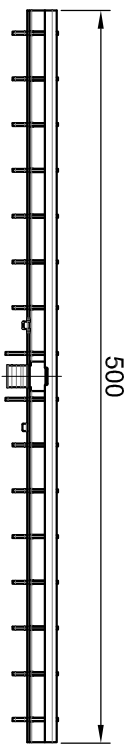
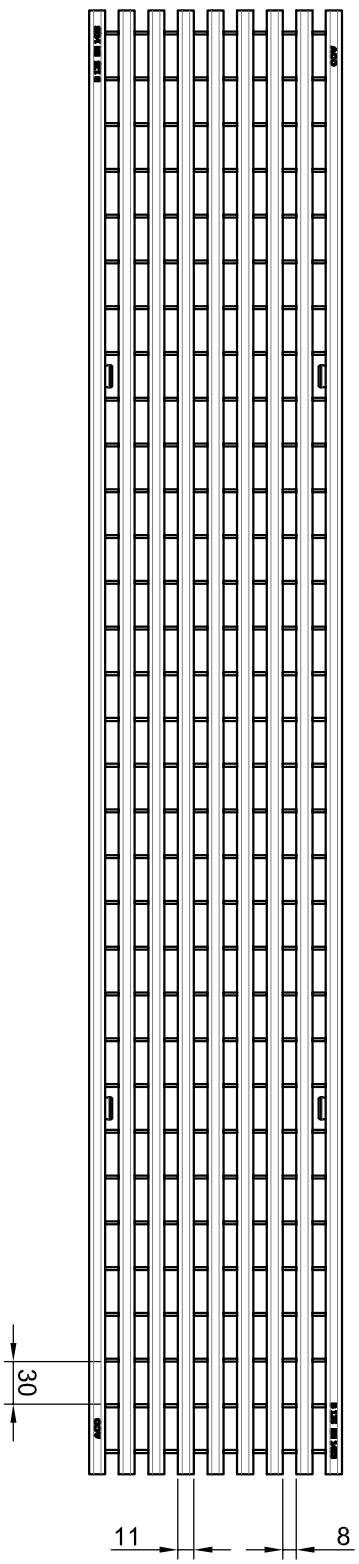
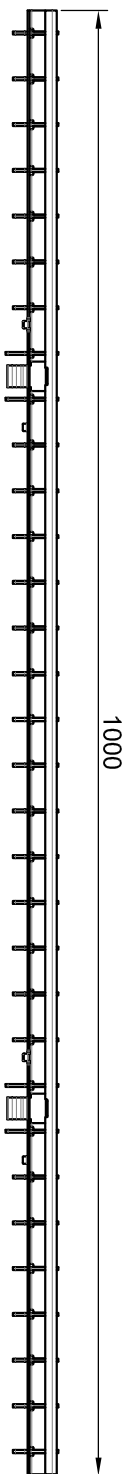

Inloopdoorsnede /  
absorption: 687 cm<sup>2</sup>/m

**Naam - Nom**  
Multiline V 150  
lengtestaafrooster uit roestvrij staal  
(AISI 304) - B 125 kN - profiel U profiel 8 mm  
grille passerelles longitudinales en acier Inoxydable

*Technische veranderingen voorbehouden - Sous réserve de changements techniques*

| Name     | Date     |
|----------|----------|
| By SB    | 05/01/17 |
| Check TS | 05/01/17 |



ACO Passavant NV/SA  
Peeenikker 8  
B - 1785 Merchtem  
Tel.: 052/38.17.70  
Fax: 052/38.17.71  
info@aco.be  
www.aco.be

| Maten in millimeter |  |
|---------------------|--|
|                     |  |
|                     |  |
|                     |  |

Artikel-Nr. - N° d'article  
133627 (1 m)  
133628 (0,5 m)

Tekening Nr - Dessin n°

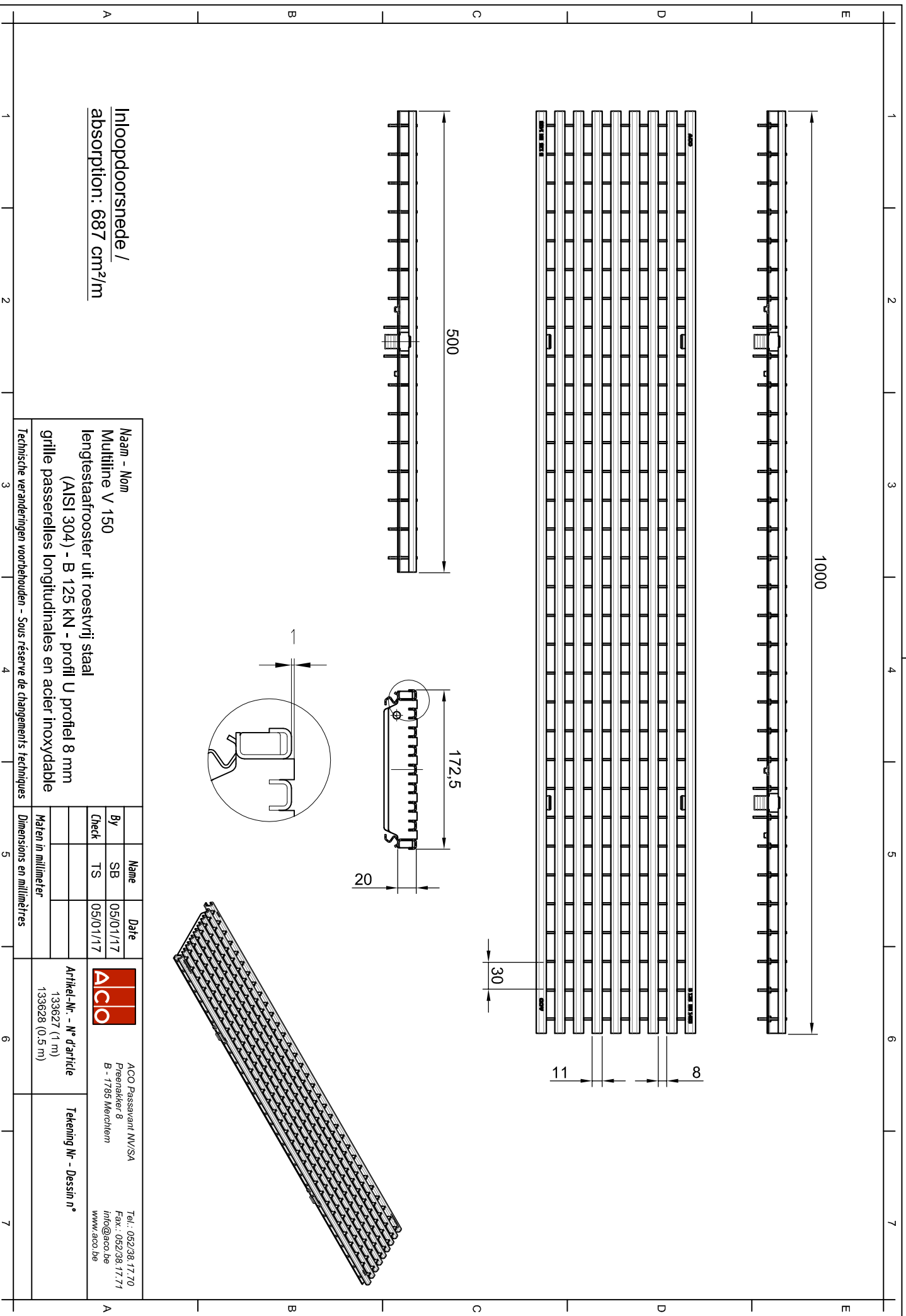

1 2 3 4 5 6 7

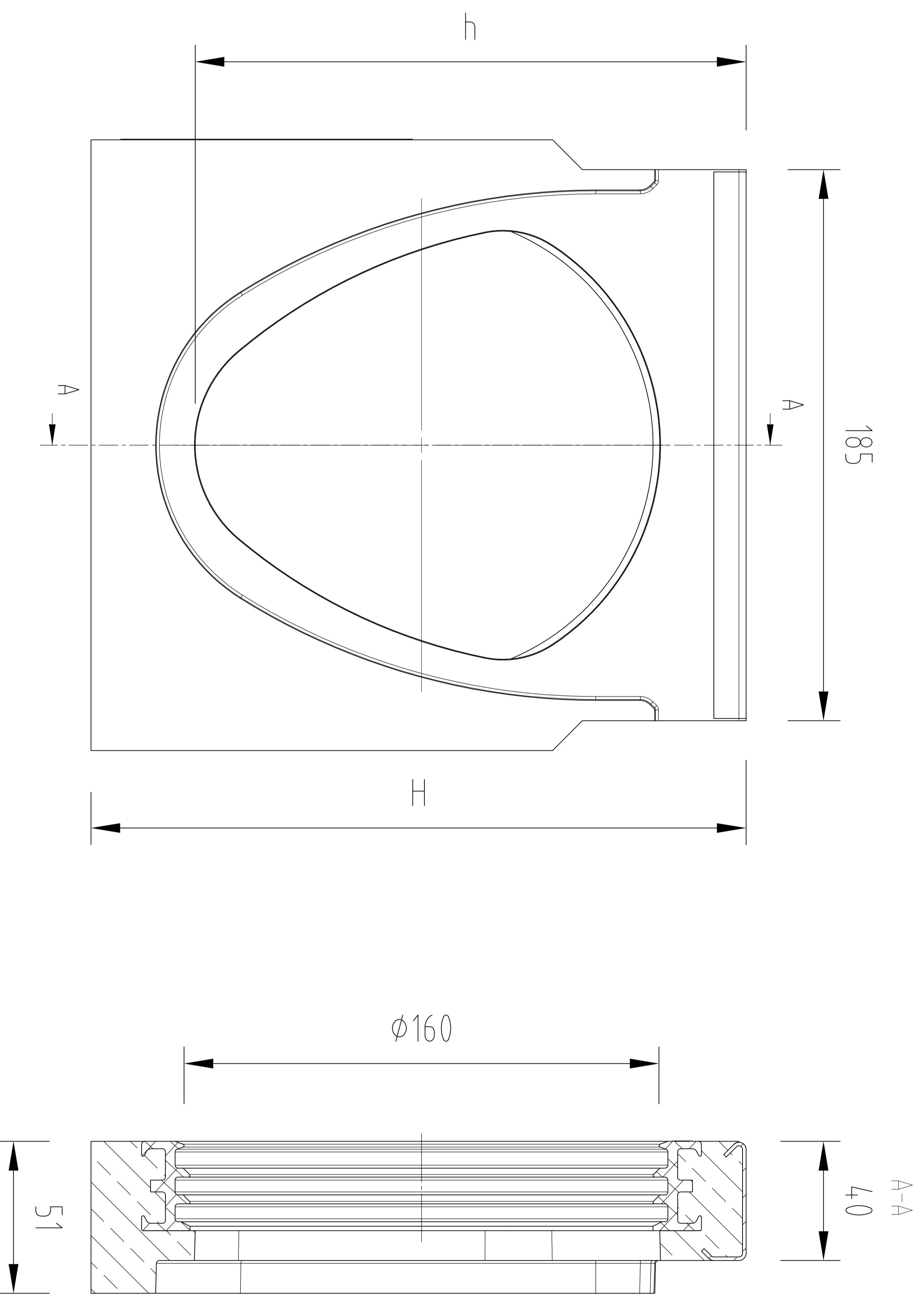
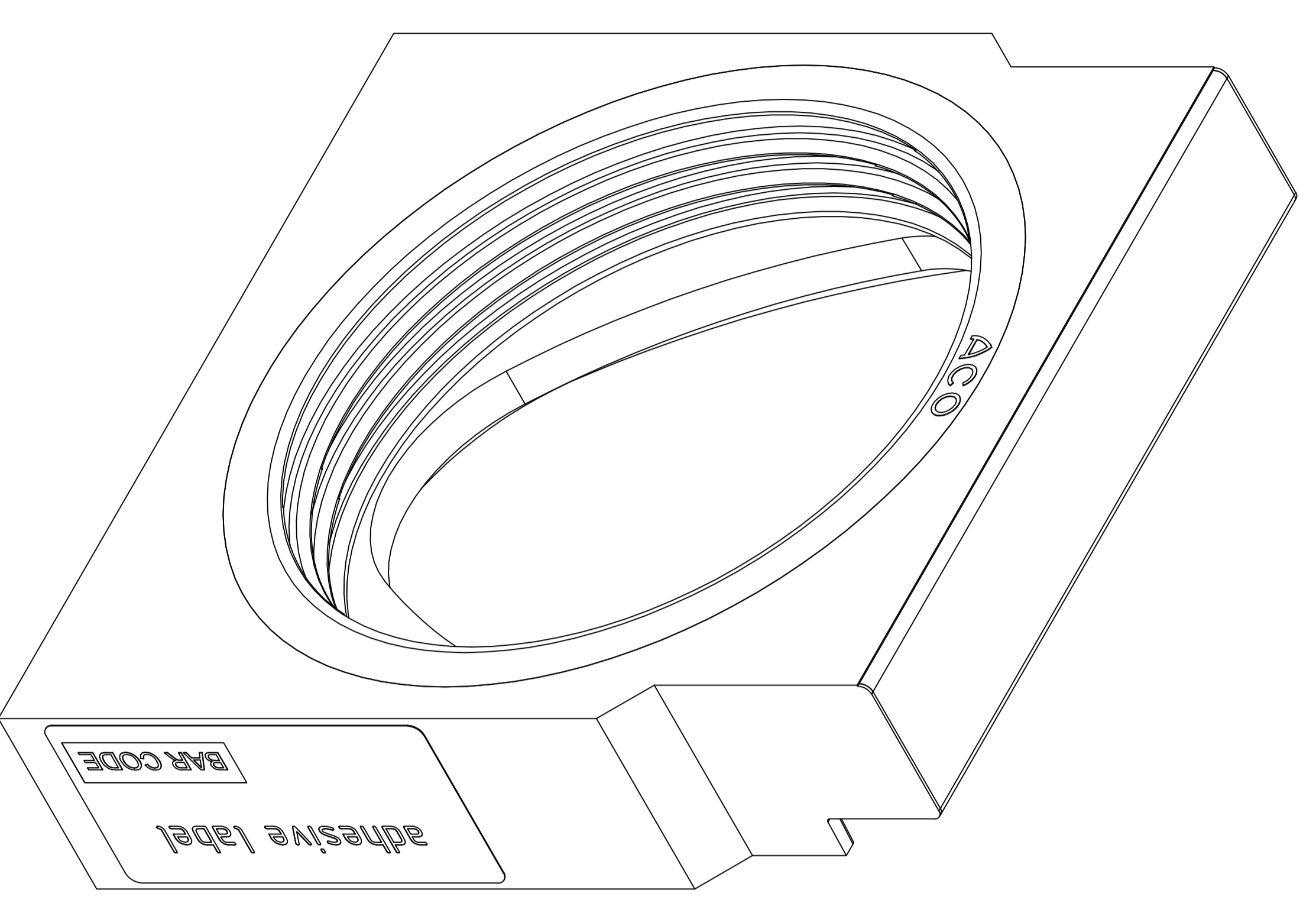

| Type      | H (mm) | h (mm) | Verzinkt staal<br>Acier galvanisé | Roestvrij staal<br>Acier inoxydable |
|-----------|--------|--------|-----------------------------------|-------------------------------------|
| Type 0.0  | 220    | 185    | 1333386                           | 133486                              |
| Type 5.0  | 245    | 210    | 1333387                           | 133487                              |
| Type 10.0 | 270    | 235    | 1333388                           | 133488                              |
| Type 20.0 | 320    | 285    | 1333389                           | 133489                              |

**Multiline V 150 S "Seal in" (0.0 - 20.0)**  
**Eindplaat met uitloop**  
**About avec sortie**

Technische veranderingen voorbehouden - Sous réserve de changements techniques

| Name         | Date     |
|--------------|----------|
| By <b>TS</b> | 19/11/21 |
| Check        |          |

Maten in millimeter

Dimensions en millimètres

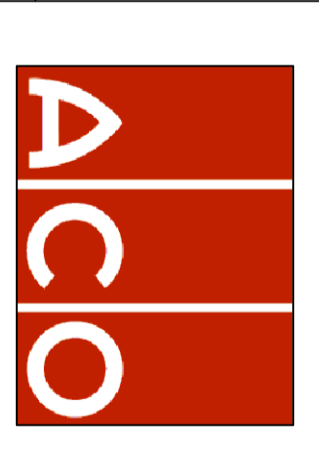

ACO Passavant NV/SA  
 Preenakker 8  
 B - 1785 Merchtem  
 Tel.: 052/38.17.70  
 Fax.: 052/38.17.71  
 info@aco.be  
 www.aco.be

Artikel-Nr. - N° d'article  
 zie tabel / voir tableau

Tekening Nr. - Dessin n°

1 2 3 4 5 6 7

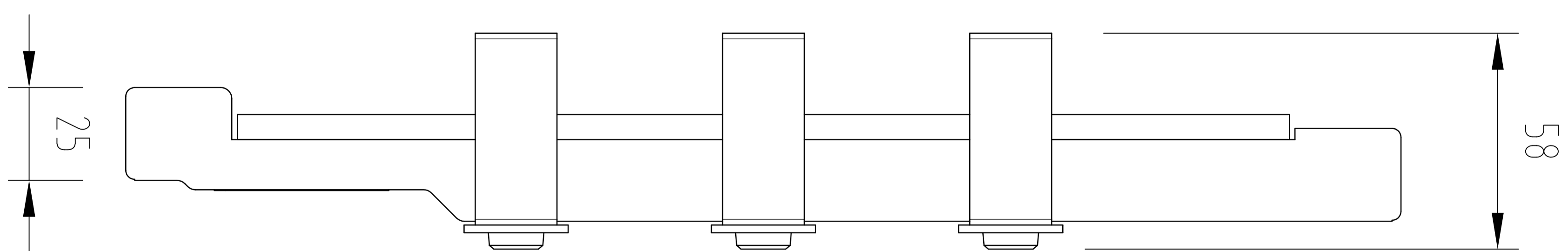
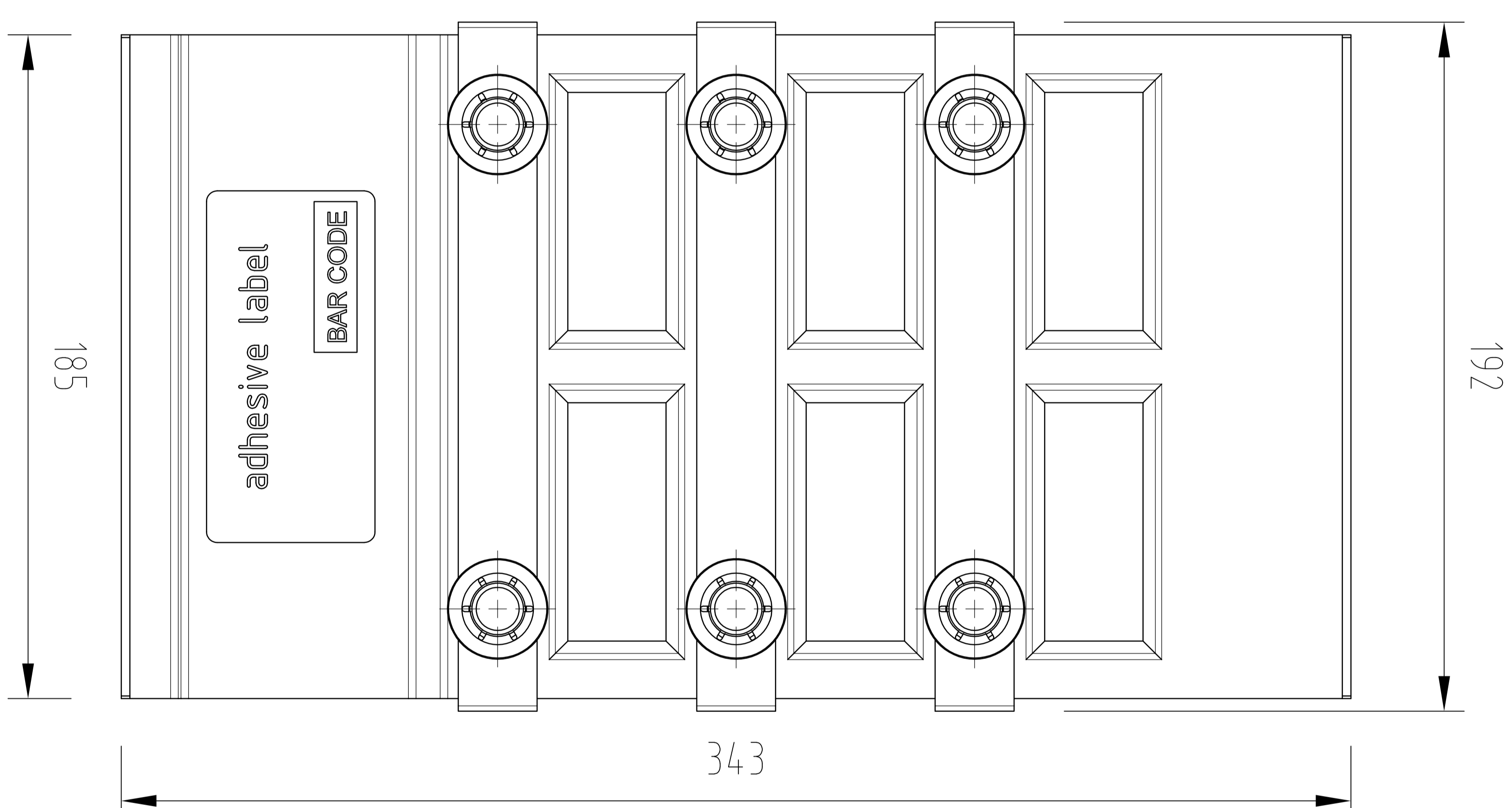
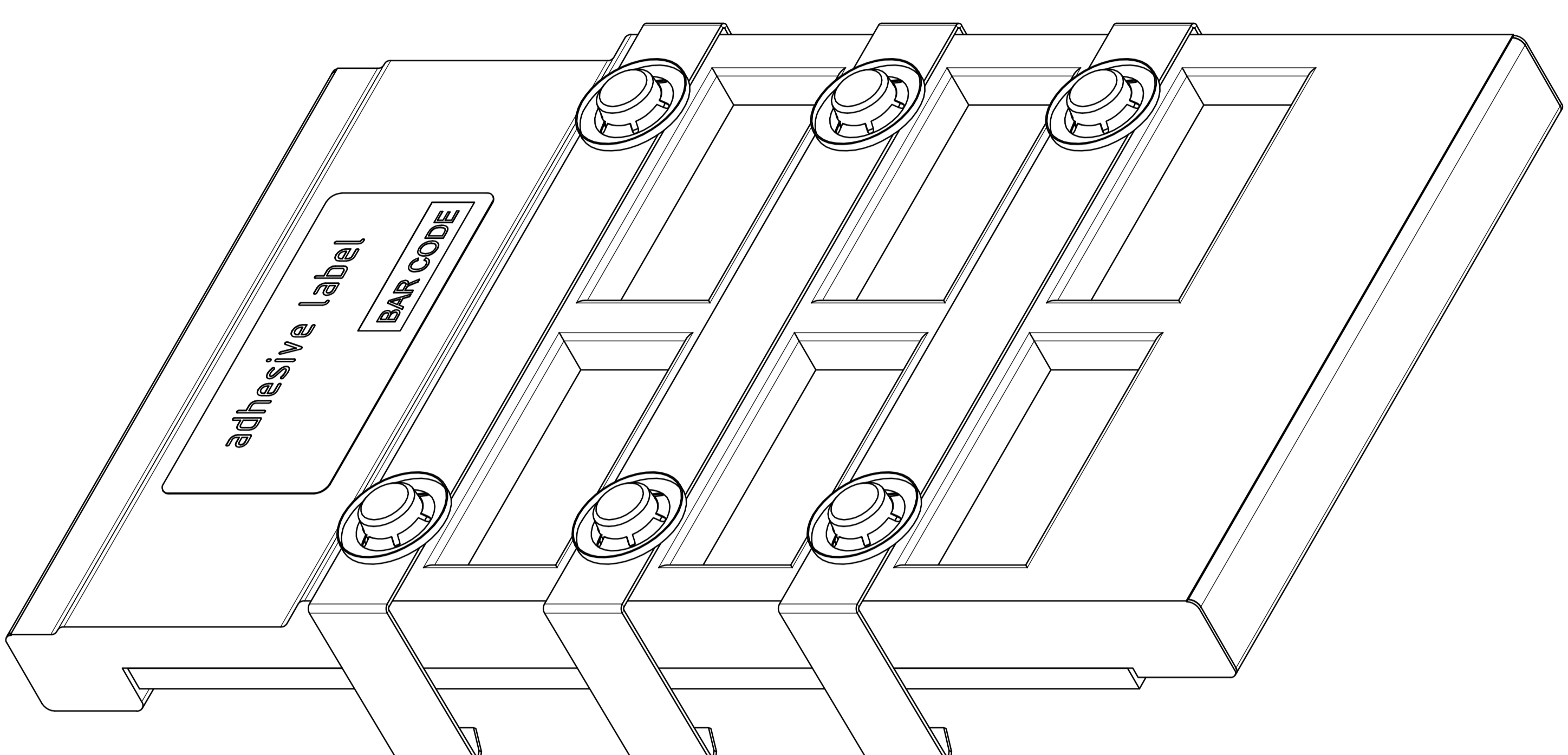

|                                   |             |                                     |             |
|-----------------------------------|-------------|-------------------------------------|-------------|
| Verzinkt staal<br>Acier galvanisé | Art. 133385 | Roestvrij staal<br>Acier inoxydable | Art. 133485 |
|-----------------------------------|-------------|-------------------------------------|-------------|

**Multiline V 150 S "Seal in" (0.0 - 20.0)**  
**Volle eindplaat - About plein**

Technische veranderingen voorbehouden - Sous réserve de changements techniques

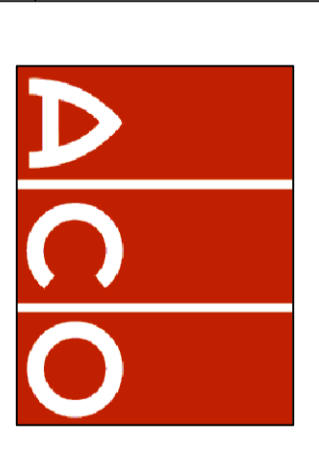

ACO Passavant NV/SA  
 Preenakker 8  
 B - 1785 Merchtem  
 Tel.: 052/38.17.70  
 Fax.: 052/38.17.71  
 info@aco.be  
 www.aco.be

|                            |          |                           |    |
|----------------------------|----------|---------------------------|----|
| Maten in millimeter        |          | Dimensions en millimètres |    |
| Name                       | Date     | By                        | TS |
| Check                      | 19/11/21 | Check                     |    |
| Artikel-Nr. - N° d'article |          | Tekenings Nr. - Dessin n° |    |
| zie tabel / voir tableau   |          |                           |    |

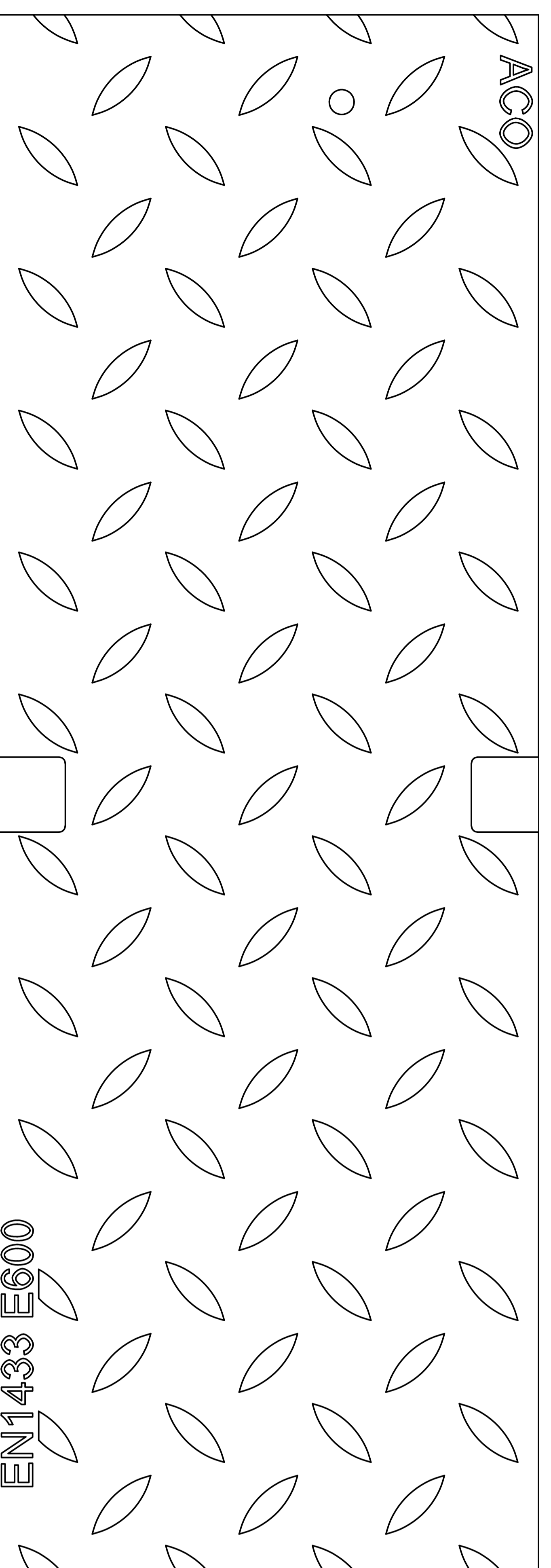
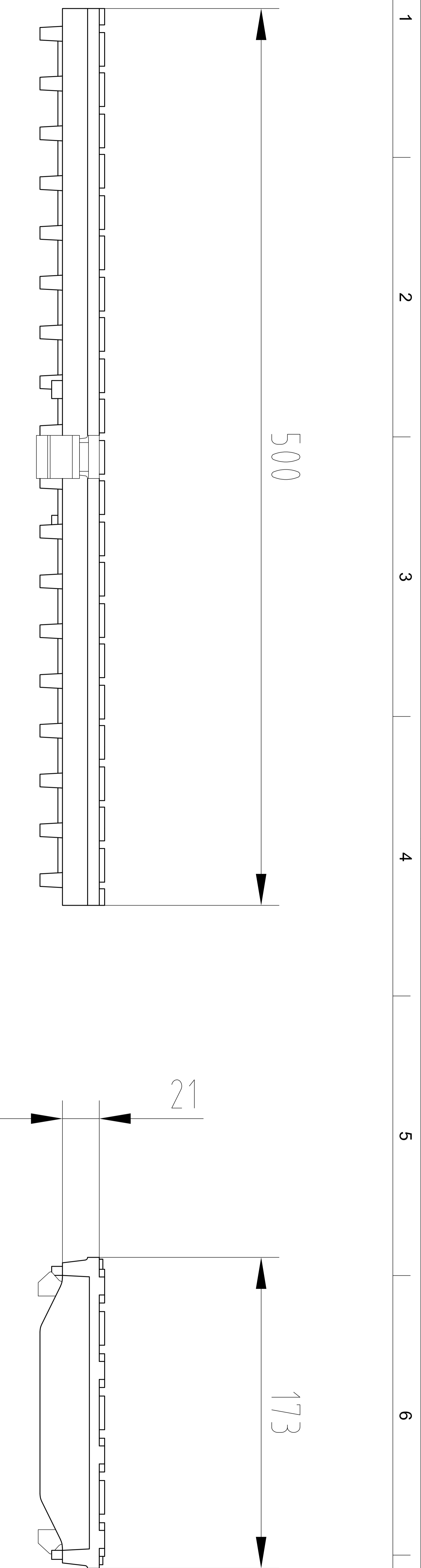

|  |  |      |  |          |  |                            |  |                        |  |
|--|--|------|--|----------|--|----------------------------|--|------------------------|--|
| Naam - Nom                             |  |      |  |          |  |                            |  |                        |  |
| Multiline V 150                        |  |      |  |          |  |                            |  |                        |  |
| volle plaat uit gietijzer Kl. E 600 KN |  |      |  |          |  |                            |  |                        |  |
| tôle larmée en fonte cl. E 600 KN      |  |      |  |          |  |                            |  |                        |  |
| Maten in millimeter                    |  | Name |  | Date     |  | ACCO                       |  | ACO Passavant NV/SA    |  |
| By                                     |  | TS   |  | 30/11/21 |  | Artikel-Nr. - N° d'article |  | Preenakker 8           |  |
| Check                                  |  |      |  |          |  | 133664                     |  | B - 1785 Merchtem      |  |
| Maten in millimeter                    |  |      |  |          |  |                            |  | Telling Nr - Dessin n° |  |
| Dimensions en millimètres              |  |      |  |          |  |                            |  | Tel.: 052/38.17.70     |  |
|  |  |      |  |          |  |                            |  | Fax.: 052/38.17.71     |  |
|  |  |      |  |          |  |                            |  | info@aco.be            |  |
|  |  |      |  |          |  |                            |  | www.aco.be             |  |

Technische veranderingen voorbehouden - Sous réserve de changements techniques

1 2 3 4 5 6 7

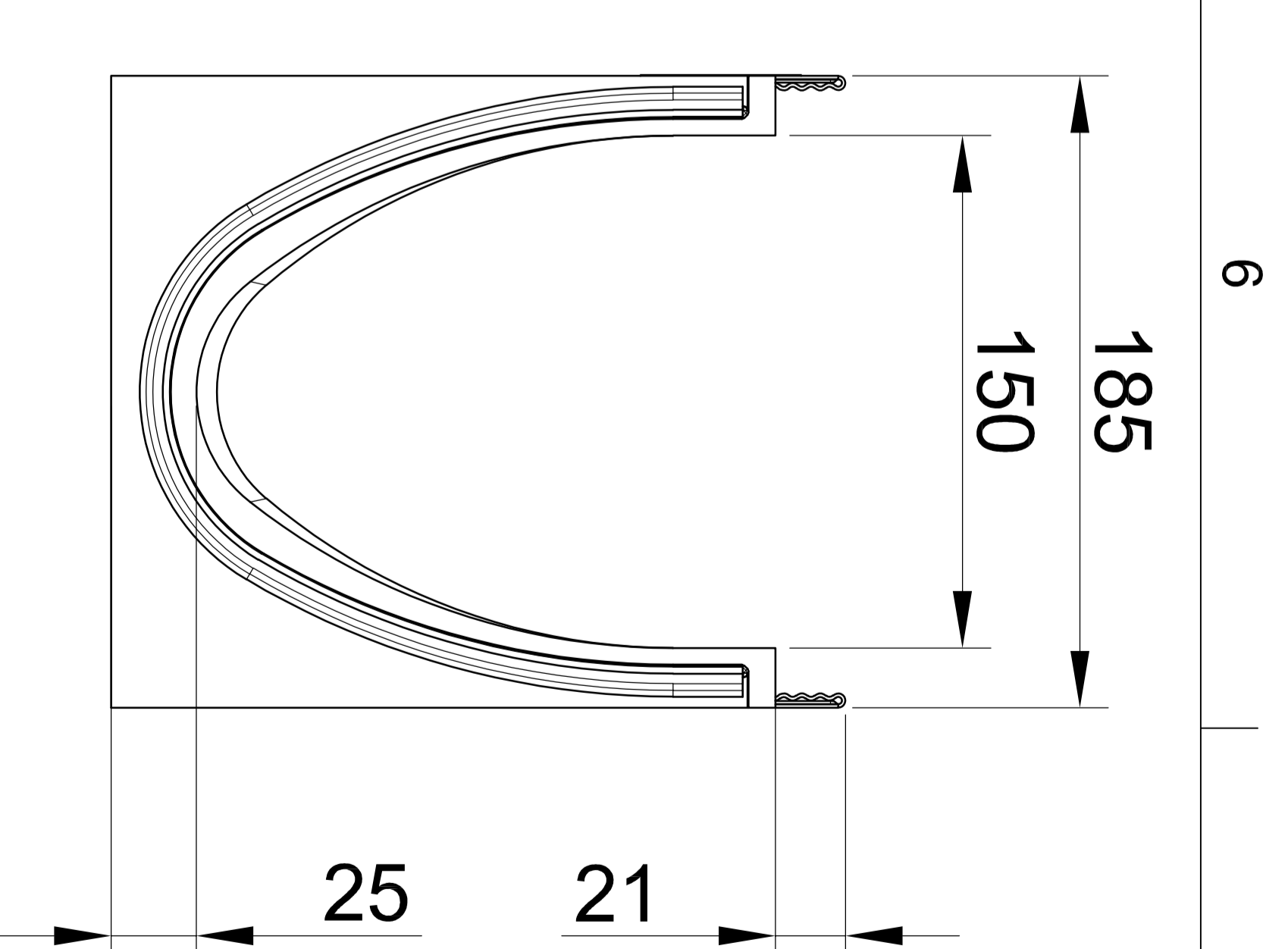
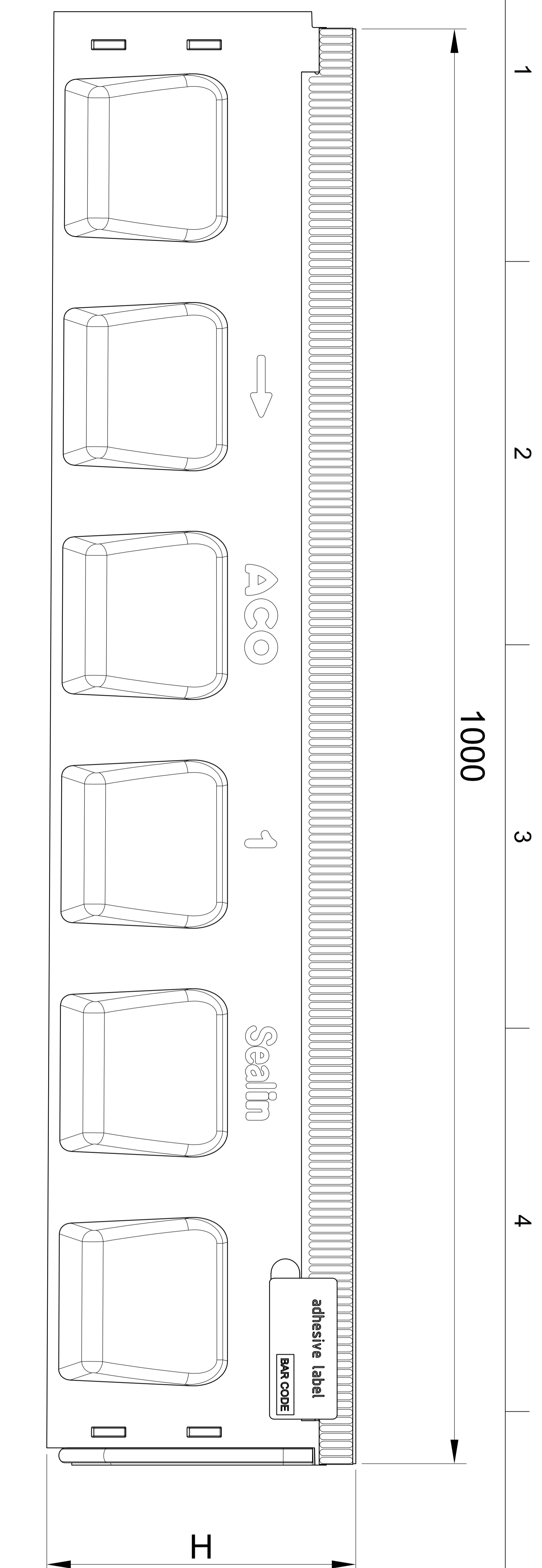

| Type | H1 (mm) | H2 (mm) | Randbescherming uit /<br>Feuille en |                                       |
|------|---------|---------|-------------------------------------|---------------------------------------|
|      |         |         | Verzinkt staal /<br>acier galvanisé | Roestvrij staal /<br>acier inoxydable |
| 1    | 210     | 215     | 133301                              | 133401                                |
| 2    | 215     | 220     | 133302                              | 133402                                |
| 3    | 220     | 225     | 133303                              | 133403                                |
| 4    | 225     | 230     | 133304                              | 133404                                |
| 5    | 230     | 235     | 133305                              | 133405                                |
| 6    | 235     | 240     | 133306                              | 133406                                |
| 7    | 240     | 245     | 133307                              | 133407                                |
| 8    | 245     | 250     | 133308                              | 133408                                |
| 9    | 250     | 255     | 133309                              | 133409                                |
| 10   | 255     | 260     | 133310                              | 133410                                |

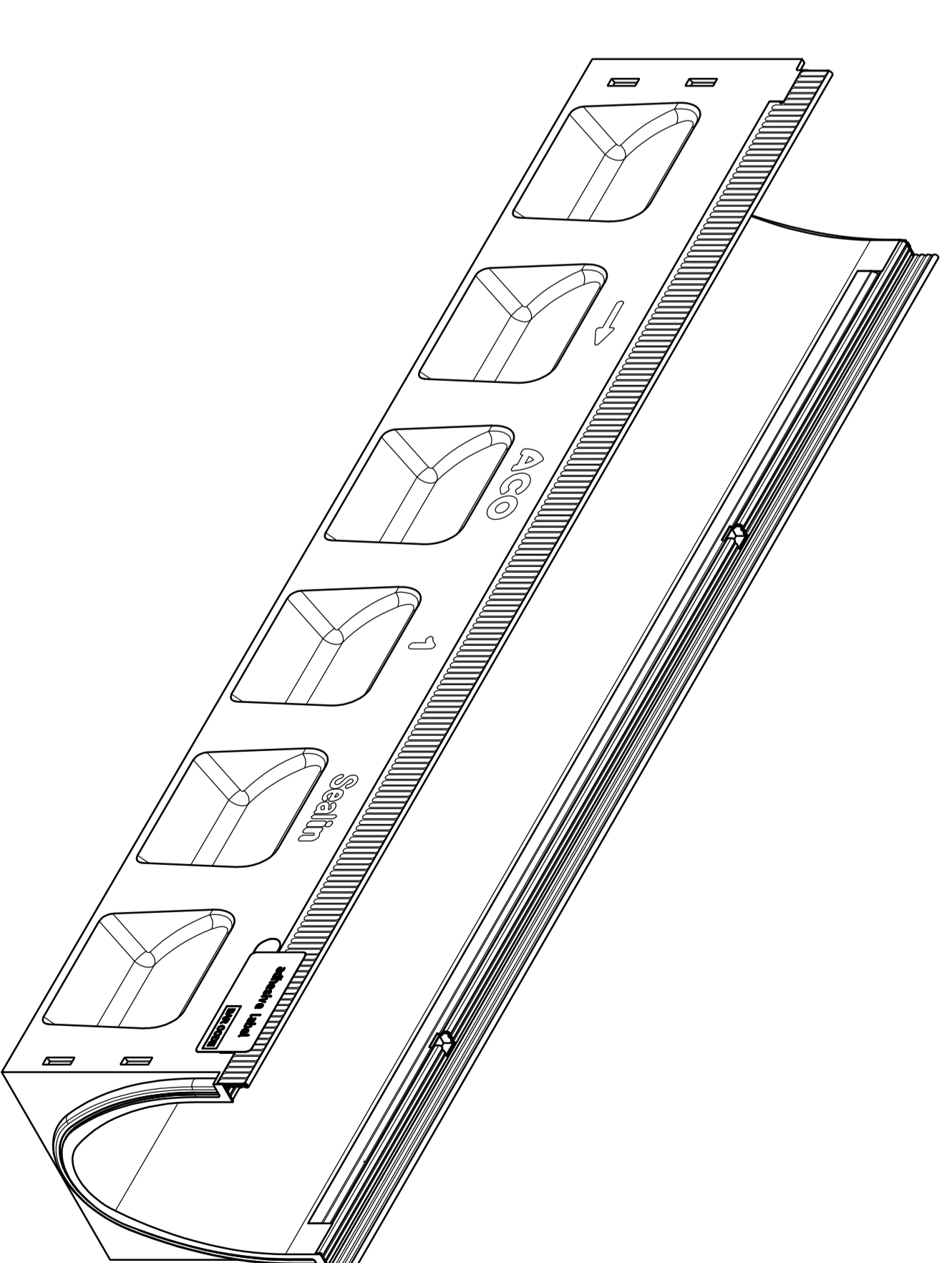

**Multiline V 150 S "Seal in" (helling - pente)**  
 met geïntegreerde EPDM-afdichting thv tand/groef  
 avec joint EPDM incorporé à la connexion mâle/fem.  
**belastingsklasse A15 - E600 classe de résistance**

| Name     | Date     |
|----------|----------|
| By SB    | 25/03/19 |
| Check TS | 25/03/19 |



ACO Passavant NV/SA Tel.: 052/38.17.70  
 Preenakker 8 Fax.: 052/38.17.71  
 B - 1785 Merchtem info@aco.be  
 www.aco.be

Artikel-Nr. - N° d'article Tekening Nr. - Dessin n°  
 zie tabel / voir tableau

Technische veranderingen voorbehouden - Sous réserve de changements techniques

Maten in millimeter  
 Dimensions en millimètres

1 2 3 4 5 6 7



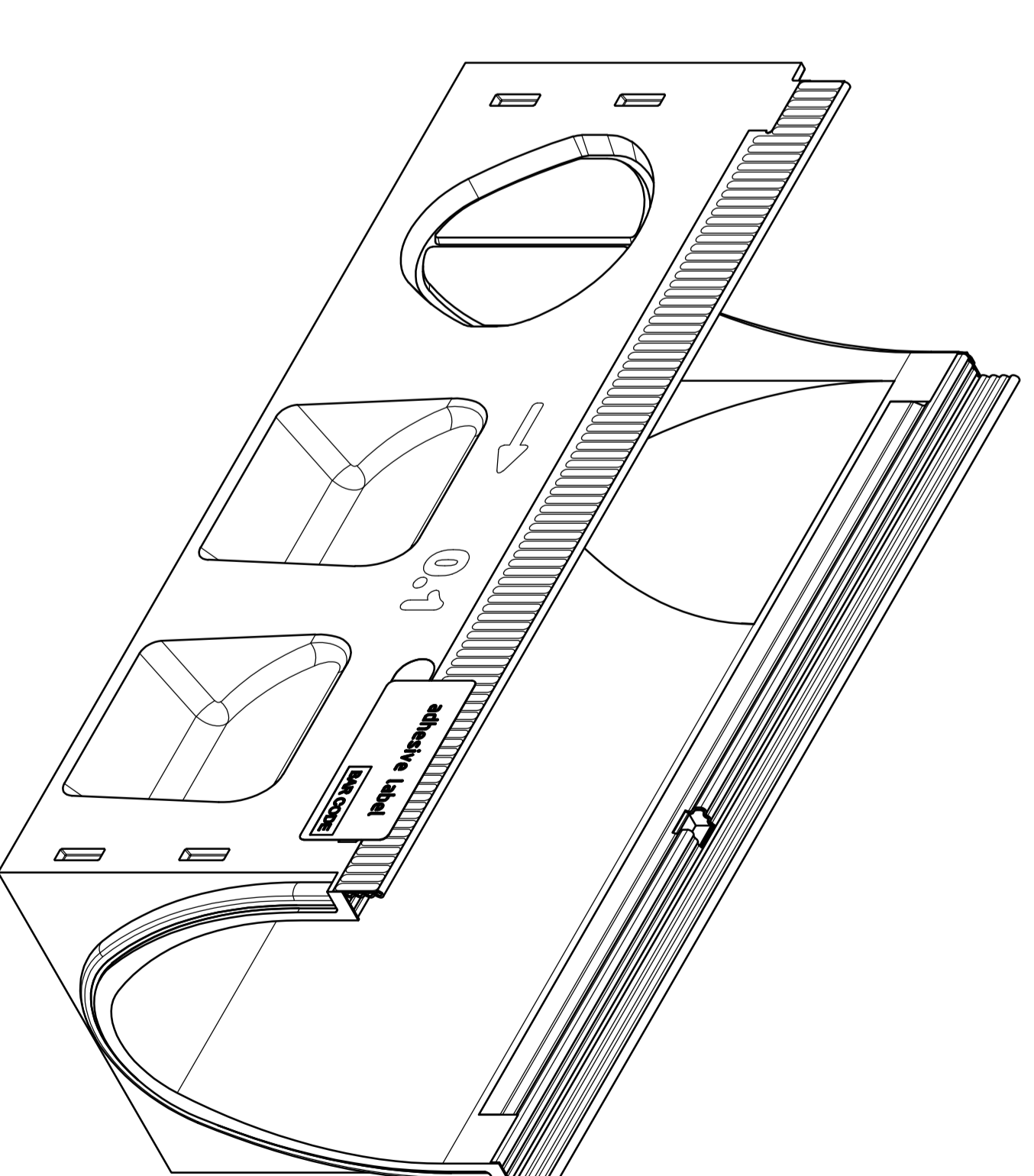
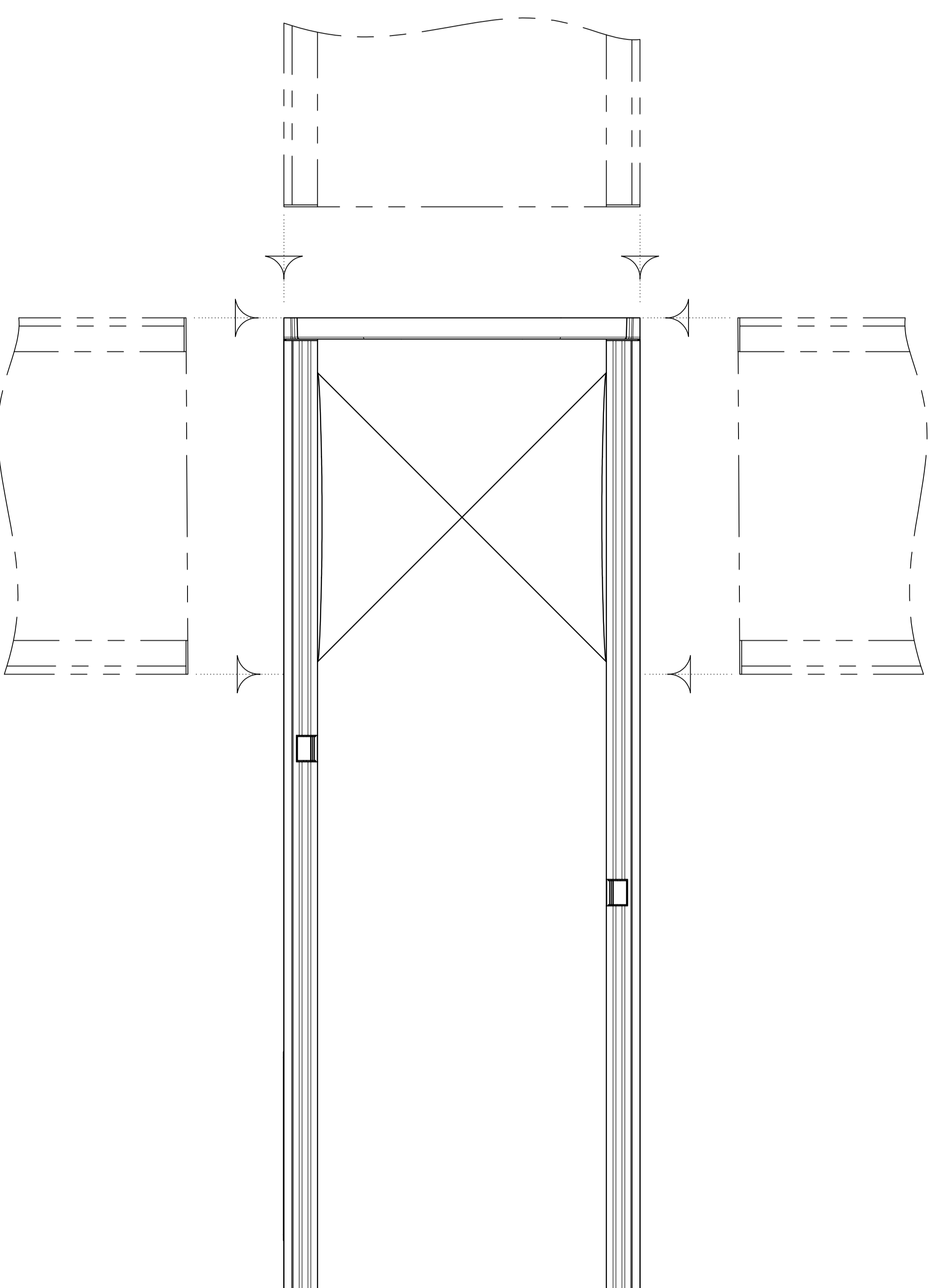
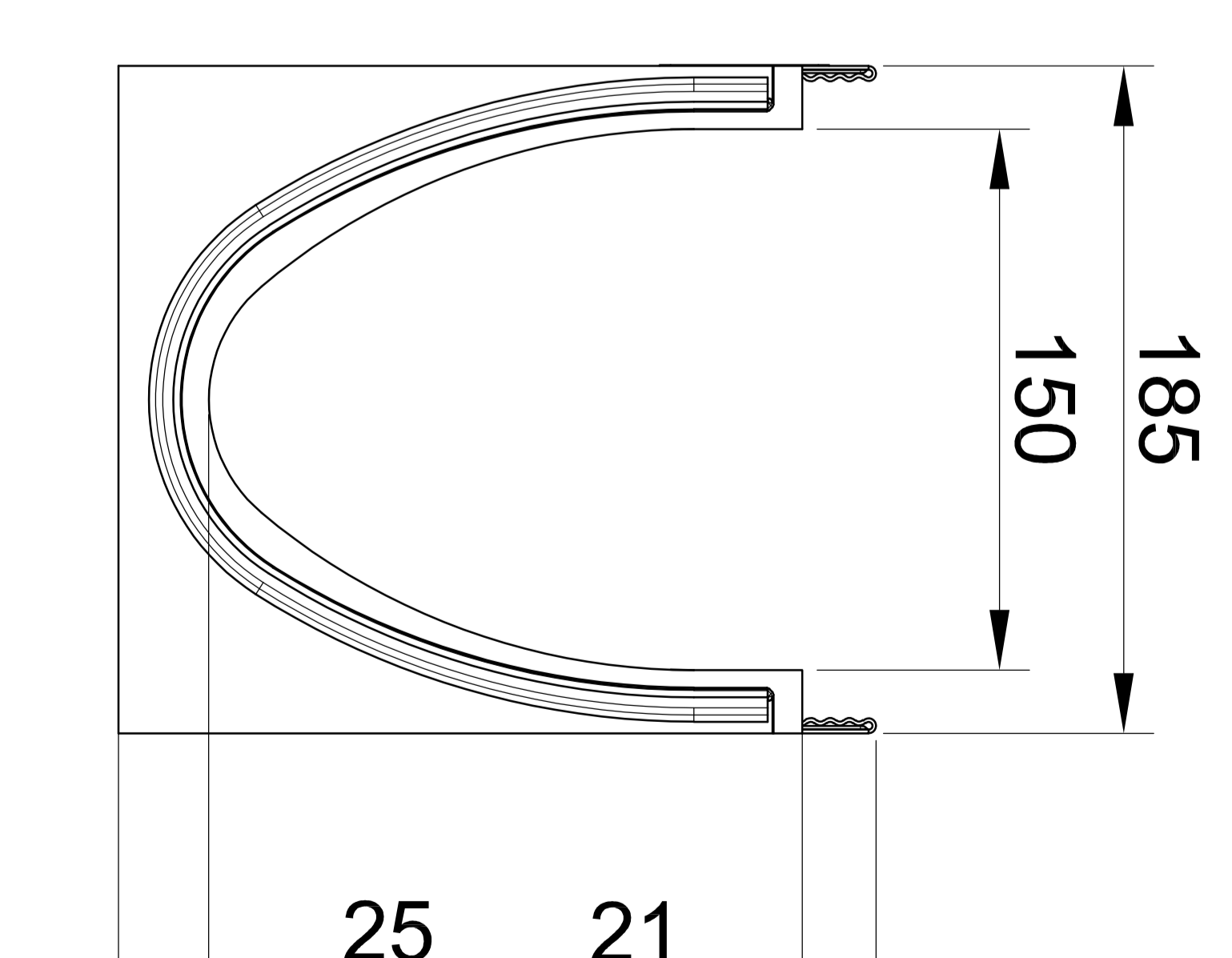
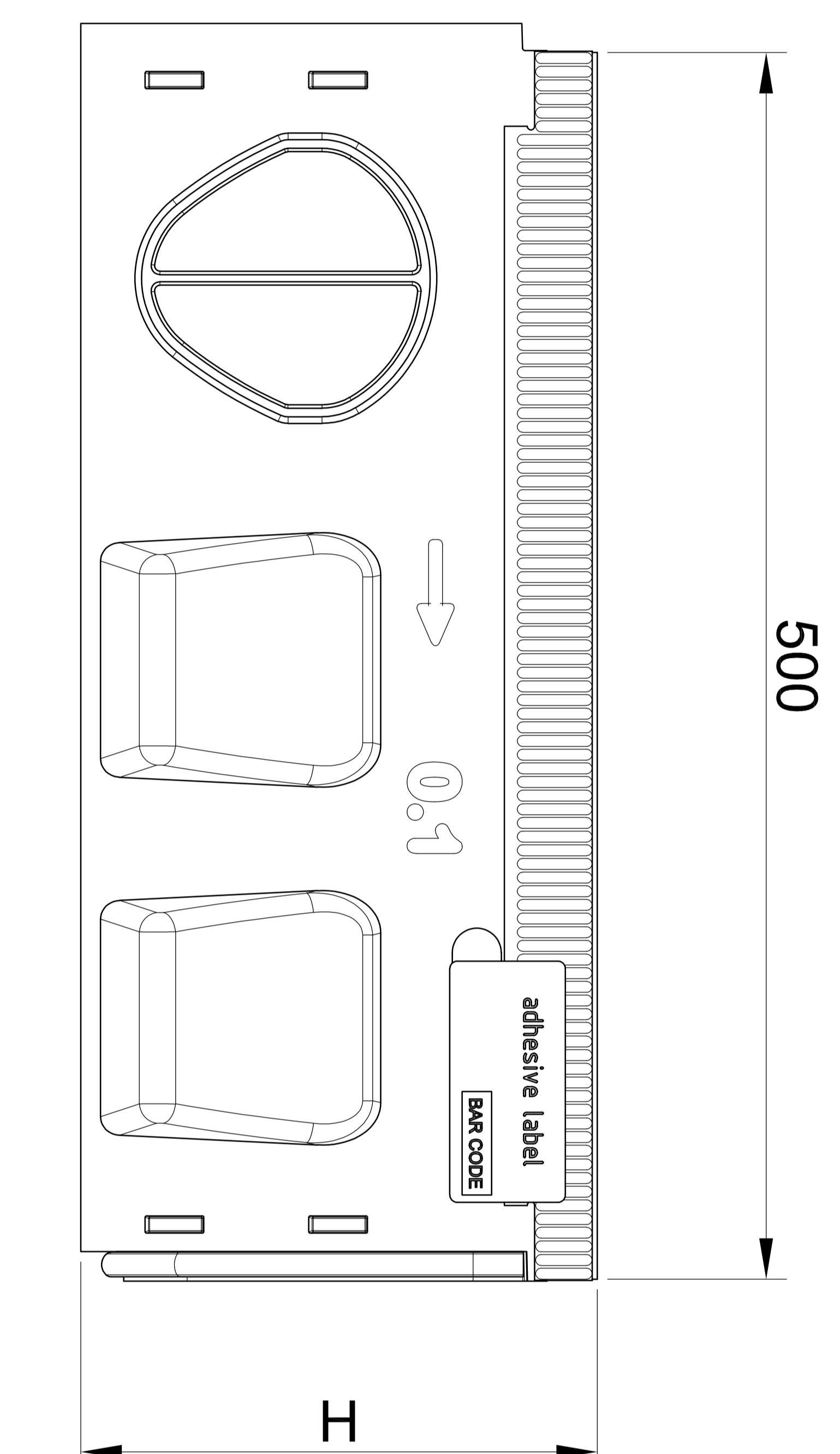

| Randbescherming uit /<br>Feuillure en |           |                               |                               |
|---------------------------------------|-----------|-------------------------------|-------------------------------|
| Type                                  | H<br>(mm) | Verzinkt st./<br>Acier galva. | Roestvrij st./<br>Acier inox. |
| 0.1                                   | 210       | 133331                        | 133431                        |
| 5.1                                   | 235       | 133341                        | 133441                        |
| 10.1                                  | 260       | 133351                        | 133451                        |
| 20.1                                  | 310       | 133371                        | 133471                        |

**Multiline V 150 S "Seal in" (0.1 - 20.1)**  
 met geïntegreerde EPDM-afdichting thv tand/groef  
 avec joint EPDM incorporé à la connexion mâle/fem.  
**belastingsklasse A15 - E600 classe de résistance**

| Name     | Date     |
|----------|----------|
| By SB    | 26/02/19 |
| Check TS | 26/02/19 |

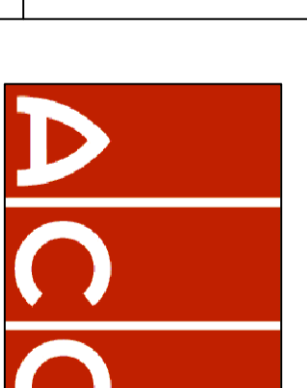

ACO Passavant NV/SA Tel.: 052/38.17.70  
 Preenakker 8 Fax.: 052/38.17.71  
 B - 1785 Merchtem info@aco.be  
 www.aco.be

Artikel-Nr. - N° d'article  
 zie tabel / voir tableau

Tekening Nr. - Dessin n°

Technische veranderingen voorbehouden - Sous réserve de changements techniques

1 2 3 4 5 6 7

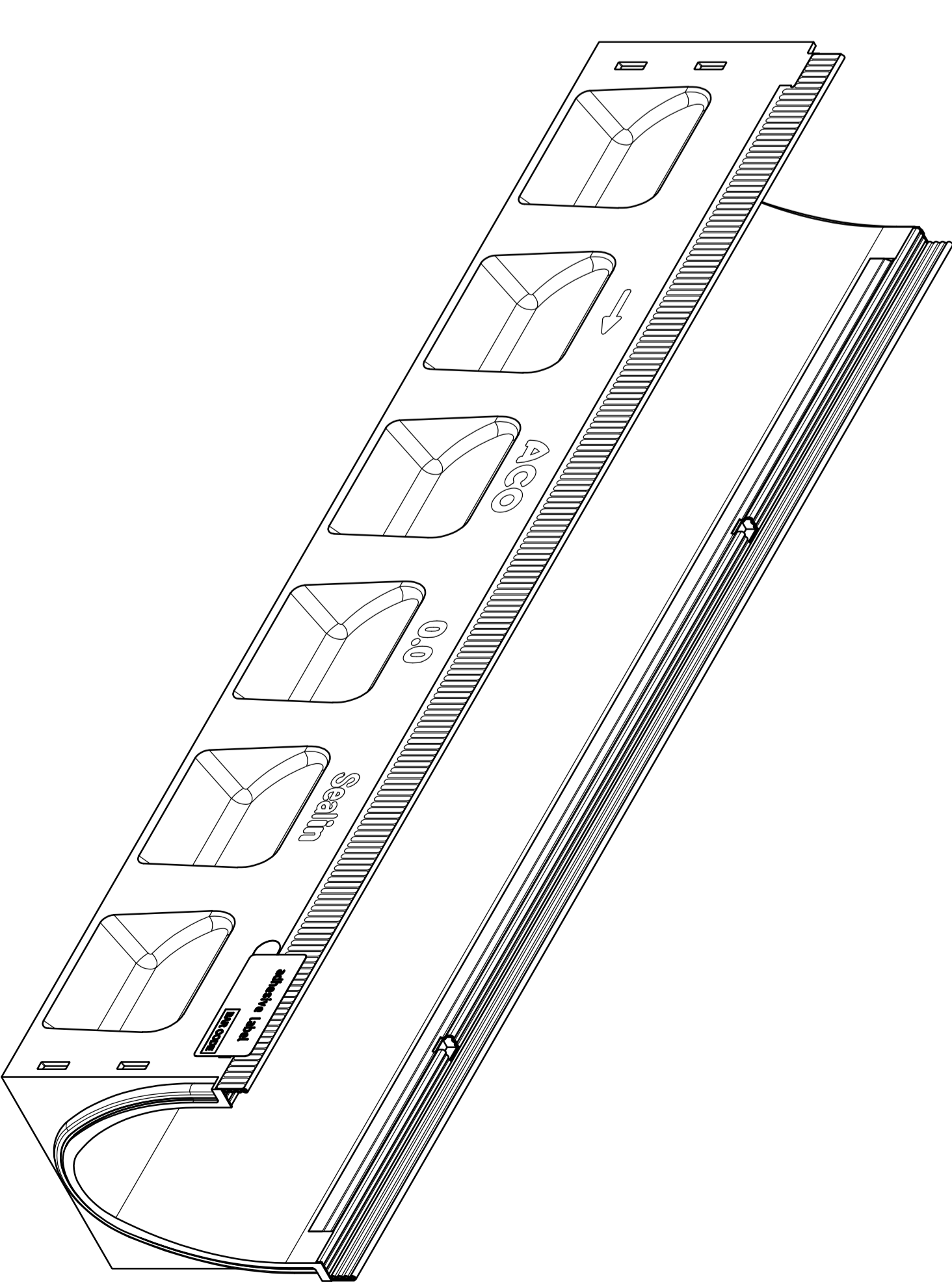
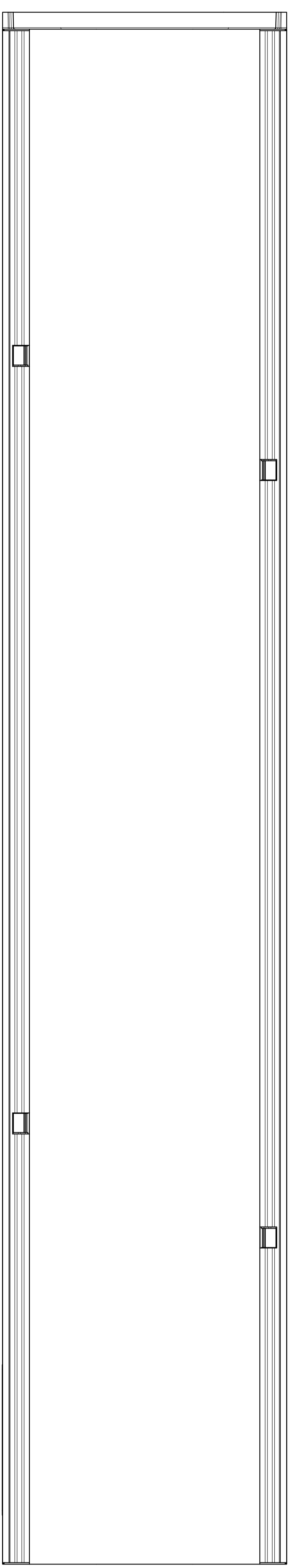
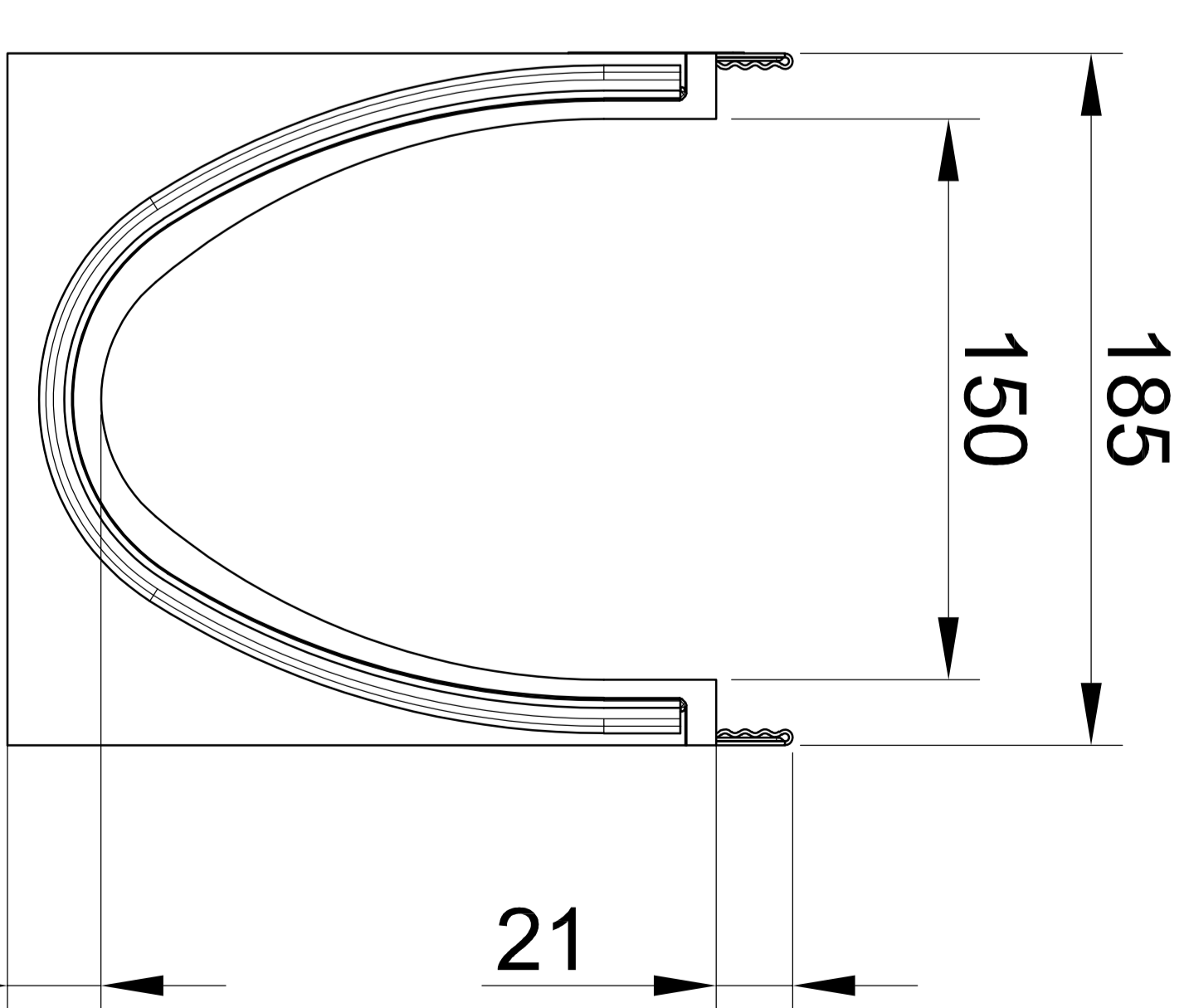
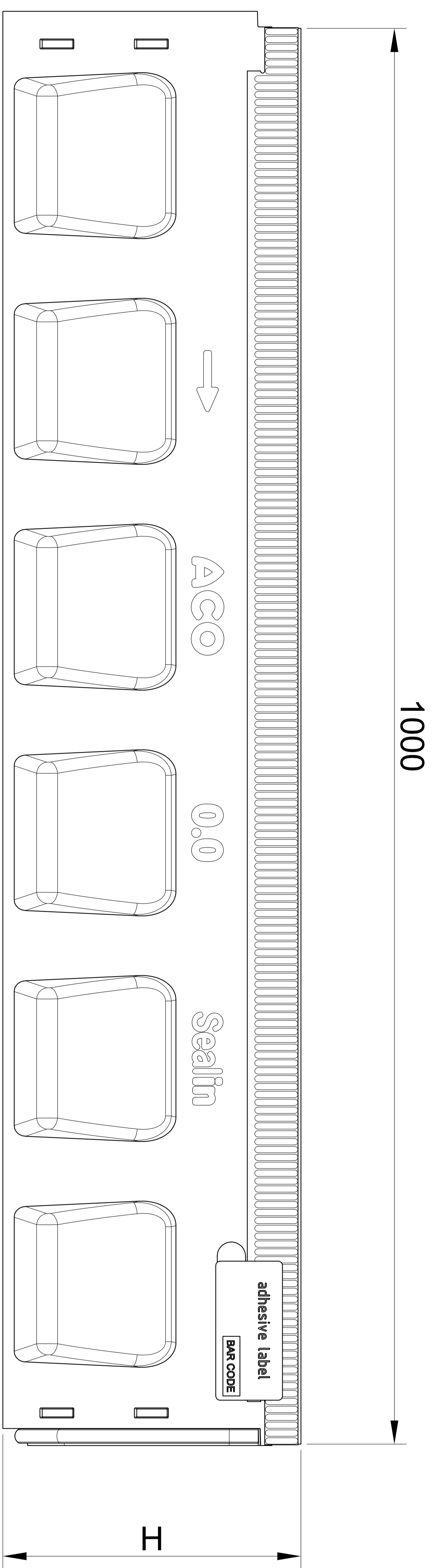

| Randbescherming uit /<br>Feuillure en |           |                               |                               |
|---------------------------------------|-----------|-------------------------------|-------------------------------|
| Type                                  | H<br>(mm) | Verzinkt st./<br>Acier galva. | Roestvrij st./<br>Acier inox. |
| 0.0                                   | 210       | 133330                        | 133430                        |
| 5.0                                   | 235       | 133340                        | 133440                        |
| 10.0                                  | 260       | 133350                        | 133450                        |
| 20.0                                  | 310       | 133370                        | 133470                        |

**Multiline V 150 S "Seal in" (0.0 - 20.0)**  
 met geïntegreerde EPDM-afdichting thv tand/groef  
 avec joint EPDM incorporé à la connexion mâle/fem.  
**belastingsklasse A15 - E600 classe de résistance**

| Name     | Date     |
|----------|----------|
| By SB    | 26/02/19 |
| Check TS | 26/02/19 |

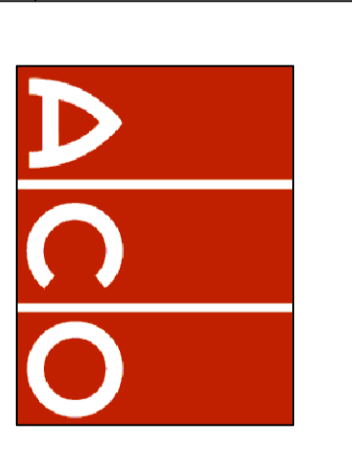

ACO Passavant NV/SA  
 Preenakker 8  
 B - 1785 Merchtem  
 Tel.: 052/38.17.70  
 Fax.: 052/38.17.71  
 info@aco.be  
 www.aco.be

Artikel-Nr. - N° d'article  
 zie tabel / voir tableau  
 Tekenings-Nr. - Dessin n°

Technische veranderingen voorbehouden - Sous réserve de changements techniques

1 2 3 4 5 6 7