

Uitloop DN 150 met geïntegreerde lippen dichting  
Sortie DN 150 avec joint à lèvres intégré

voor kanaal / pour caniveau type	Verzinkt staal / Acier galvanisé	Roestvrij staal / Acier inoxydable
0.	153391	153491
10.	153393	153493
20.	153394	153494

Randbescherming uit / Feuillure en

Multiline V 300 S "Seal in" (0. - 20.)  
zandvanger  
met geïntegreerde EPDM-afdichting thv tand/groef  
désableur  
avec joint EPDM incorporé à la connexion mâle/fem.  
belastingklasse A15 - E600 classe de résistance

Name

Date

By

TS

26/11/21

Check

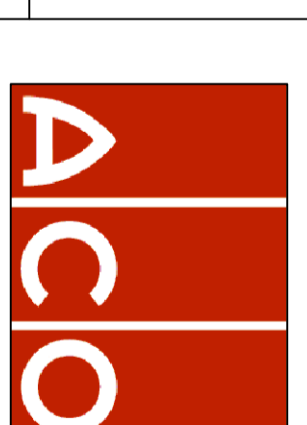

ACO Passavant NV/SA Tel.: 052/38.17.70  
Preenakker 8 Fax.: 052/38.17.71  
B - 1785 Merchtem info@aco.be  
www.aco.be

Artikel-Nr. - N° d'article

Tekening Nr - Dessin n°

zie tabel / voir tableau

Maten in millimeter

Dimensions en millimètres

Technische veranderingen voorbehouden - Sous réserve de changements techniques

1

2

3

4

5

6

7

1

2

3

A-A

5

6

7

A

B

C

D

E

A

B

C

D

E

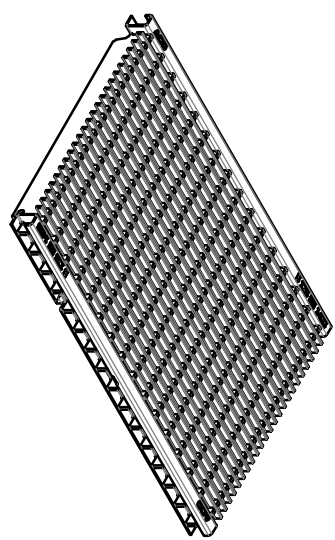
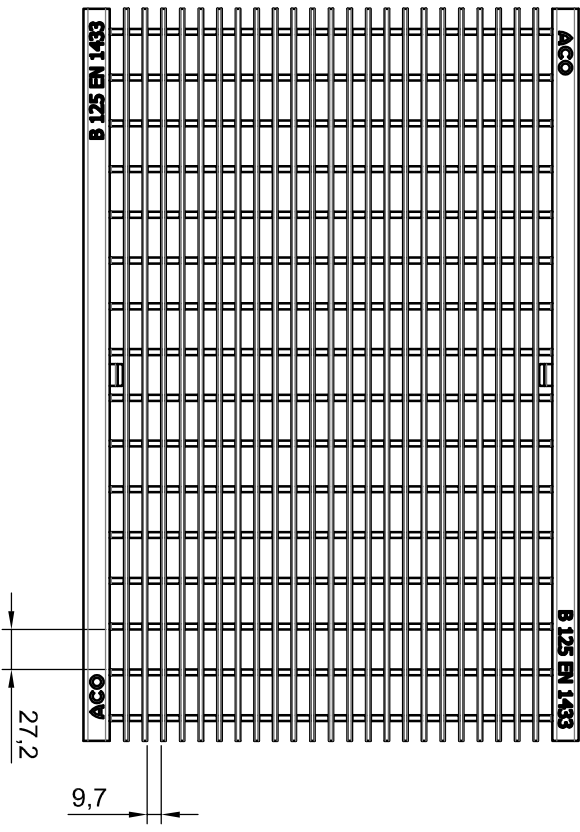
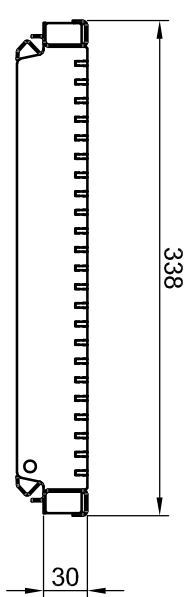
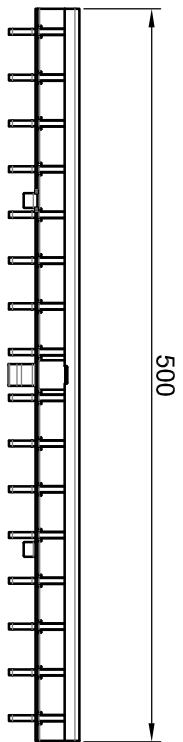

Inlooppdoorsnede /  
absorption: 2028 cm<sup>2</sup>/m

**Naam - Nom**  
Multiline V 300  
Q+ maastrooster - verzinkt staal kl. B 125 KN  
(mazen / mailles 30x10 mm)  
Q+ grille caillleboits - acier galvanisé cl. B 125 KN

Technische veranderingen voorbehouden - Sous réserve de changements techniques

By	Name	Date
SB	SB	23/05/19
Check	TS	23/05/19

Maten in millimeter



Artikel-Nr. - N° d'article  
133674

ACO Passavant NV/SA  
Pleerakker 8  
B - 1785 Merchtem  
Tel.: 052/238.17.70  
Fax.: 052/238.17.71  
info@aco.be  
www.aco.be

Tekening Nr - Dessin n°

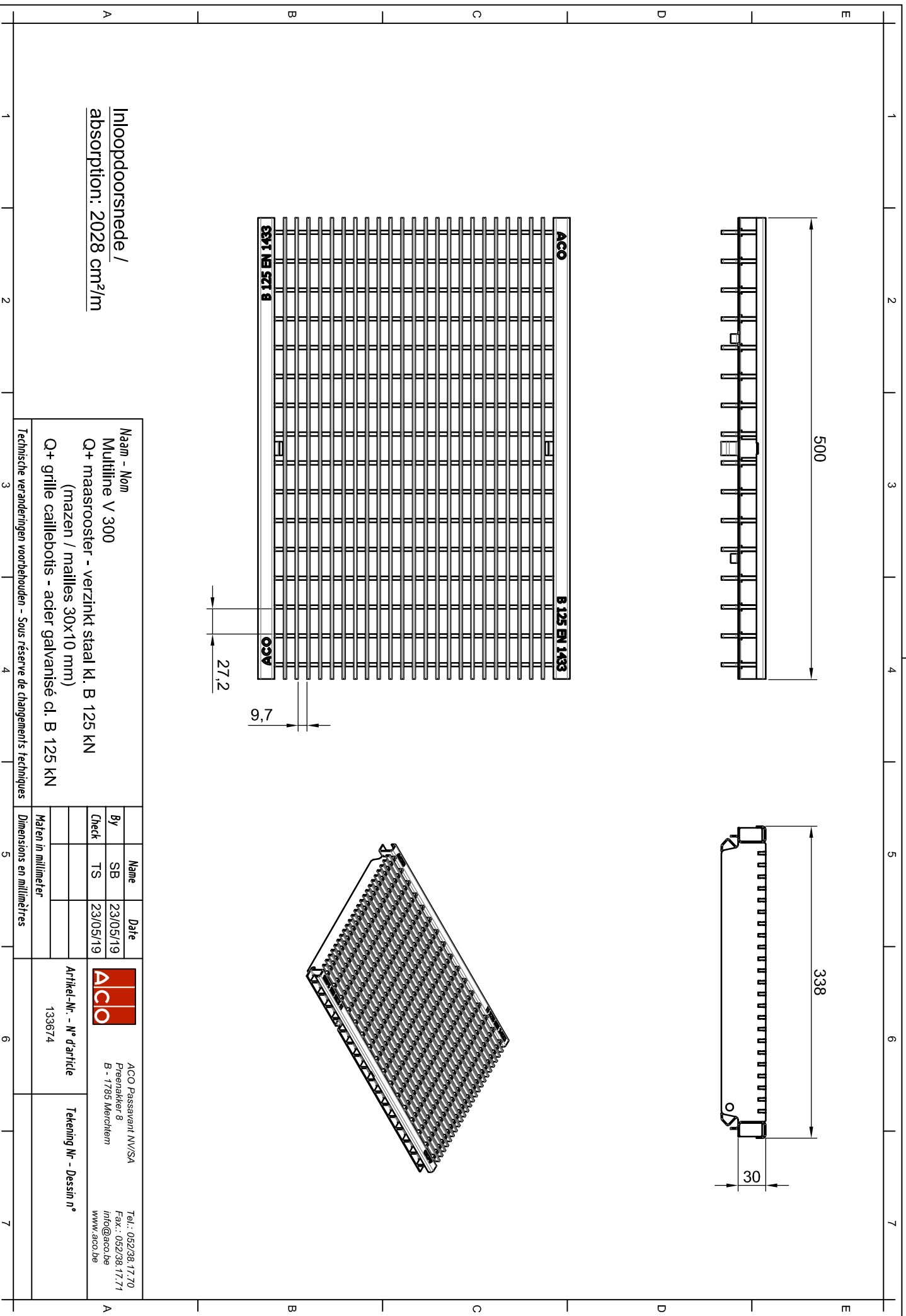

1 2 3 4 5 6 7

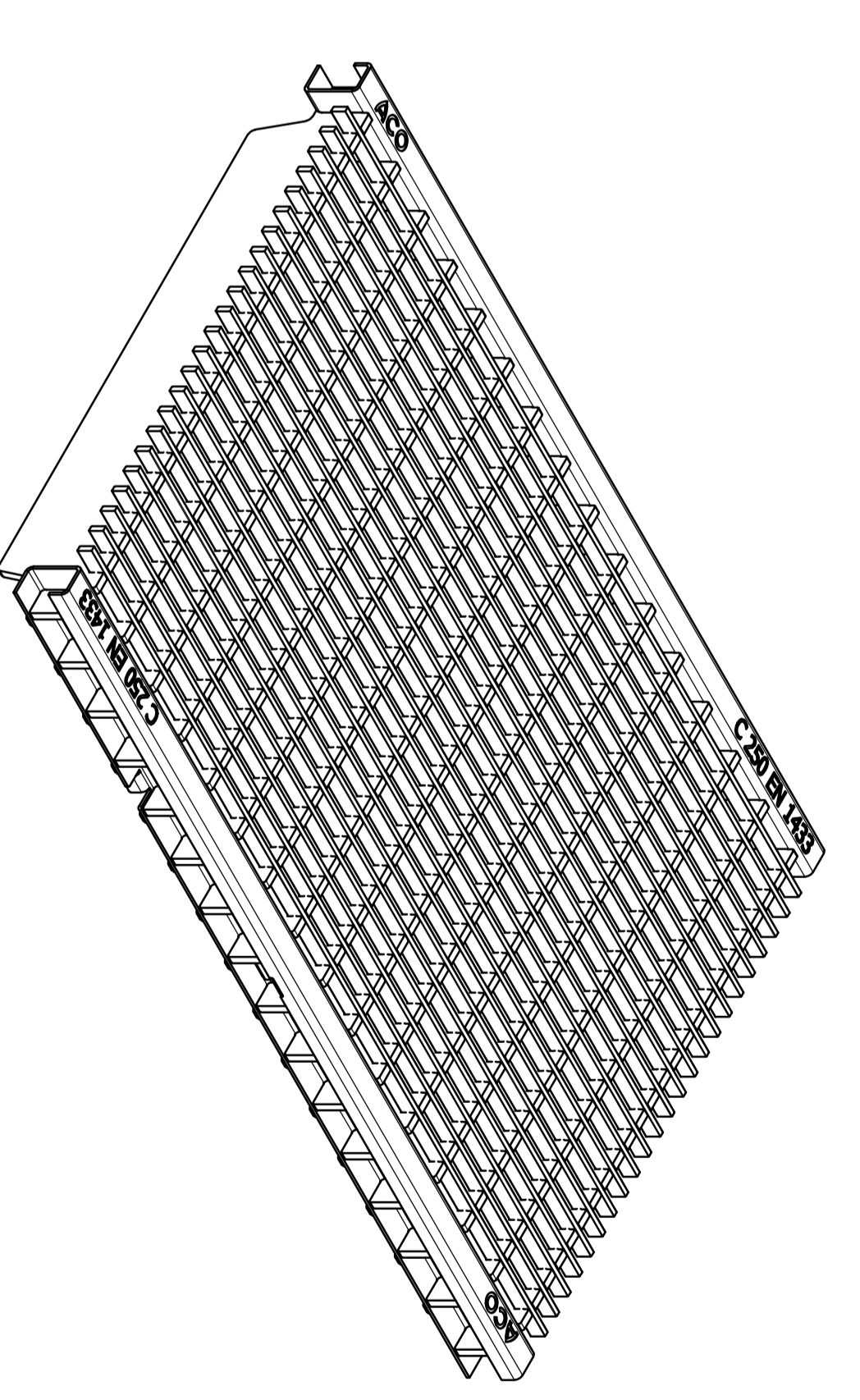
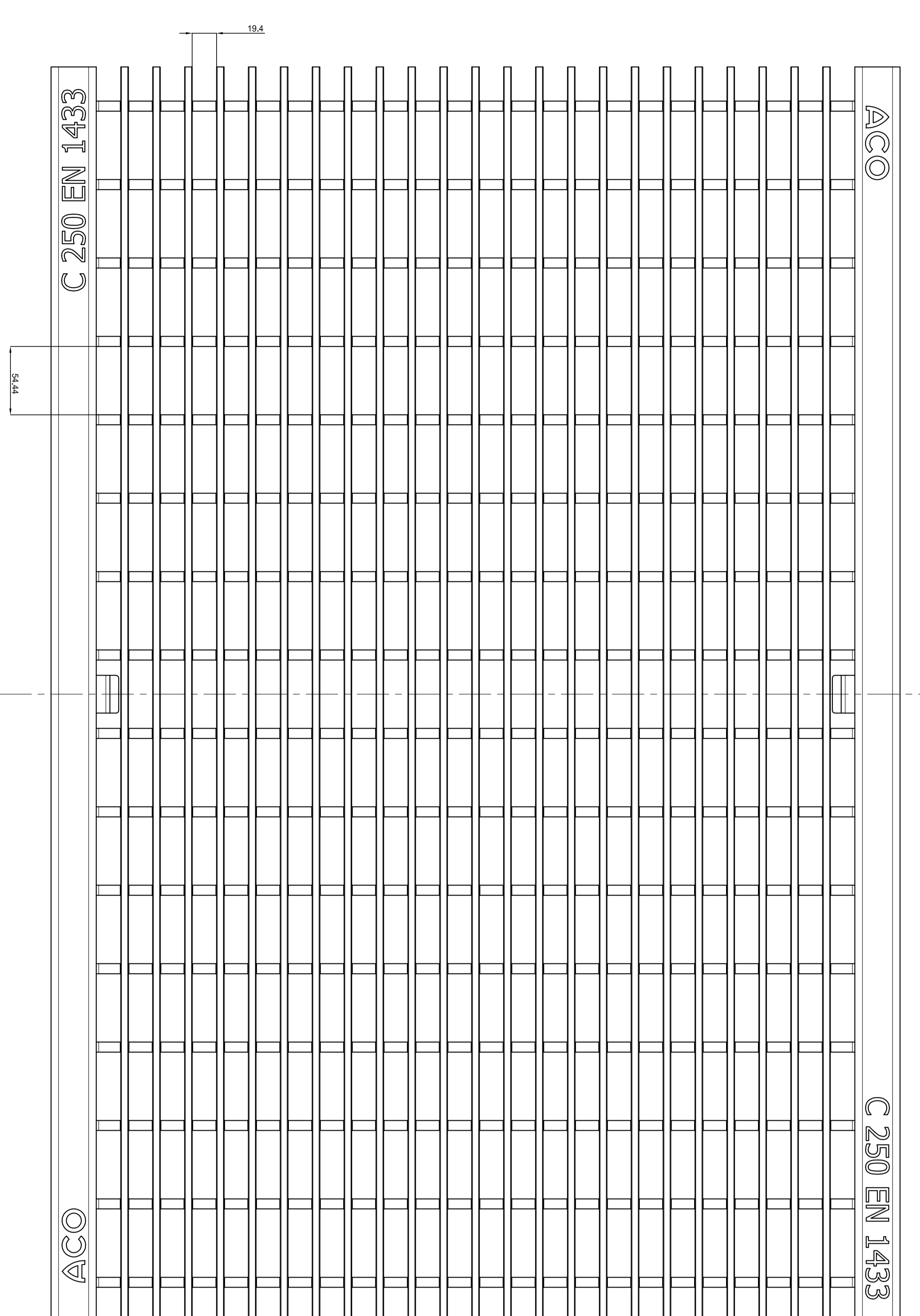
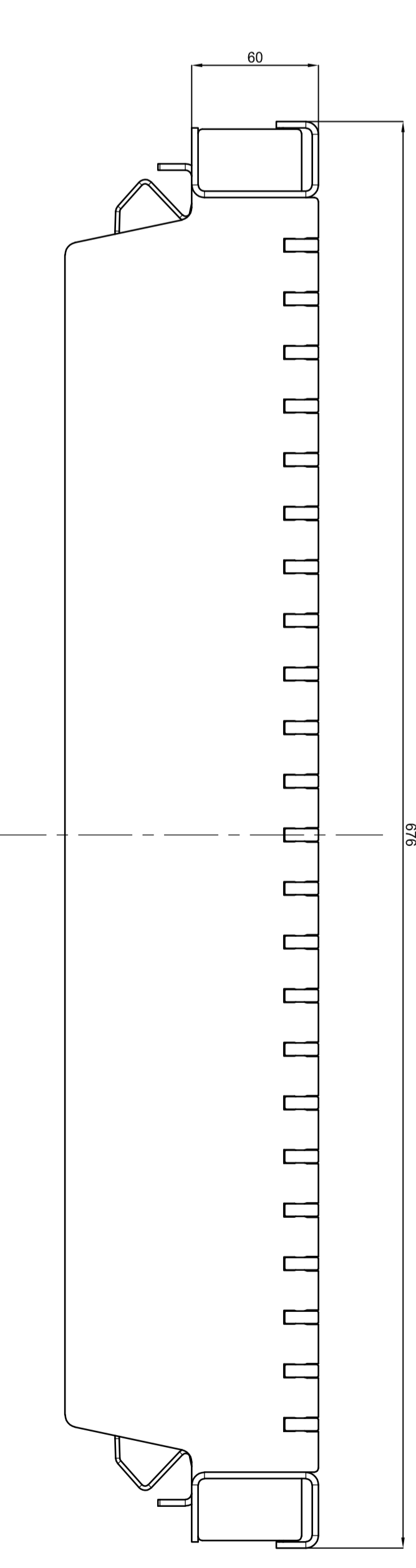
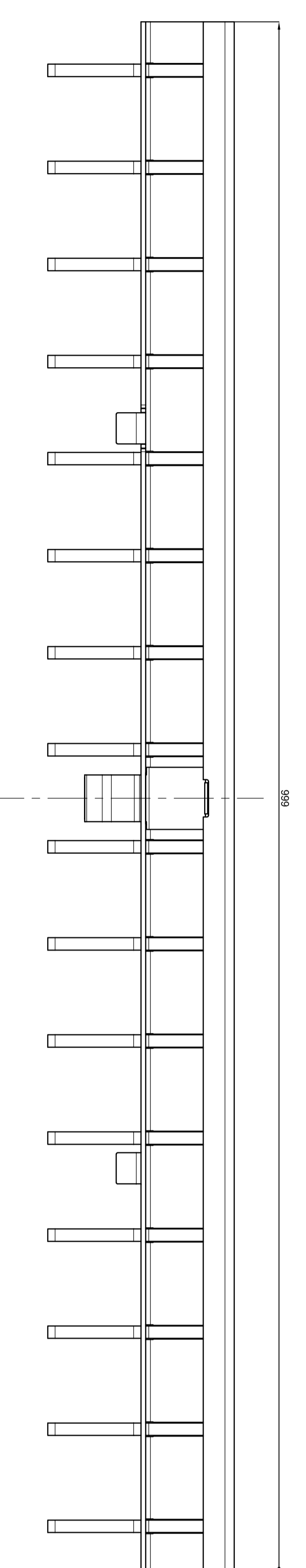

Inlooppdoorsnede /  
absorption: 2028 cm<sup>2</sup>/m

Naam - Nom  
**Multiline V 300**  
Q+ maastrooster uit verzinkt staal kl. C 250 KN  
(AISI 304, mazen / mailles 30x10 mm)  
Q+ grille caillbotis en acier galvanisé cl. C 250 KN

Technische veranderingen voorbehouden - Sous réserve de changements techniques

	Name	Date
By	TS	30/11/21
Check		

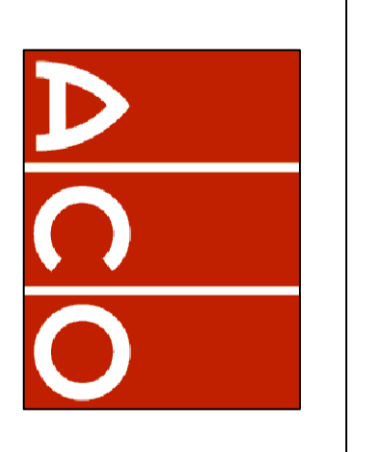

ACO Passavant NV/SA  
Preenakker 8  
B - 1785 Merchtem  
Tel.: 052/38.17.70  
Fax.: 052/38.17.71  
info@aco.be  
www.aco.be

Maten in millimeter		Dimensions en millimètres	

A

1 2 3 4 5 6 7

B

C

D

E

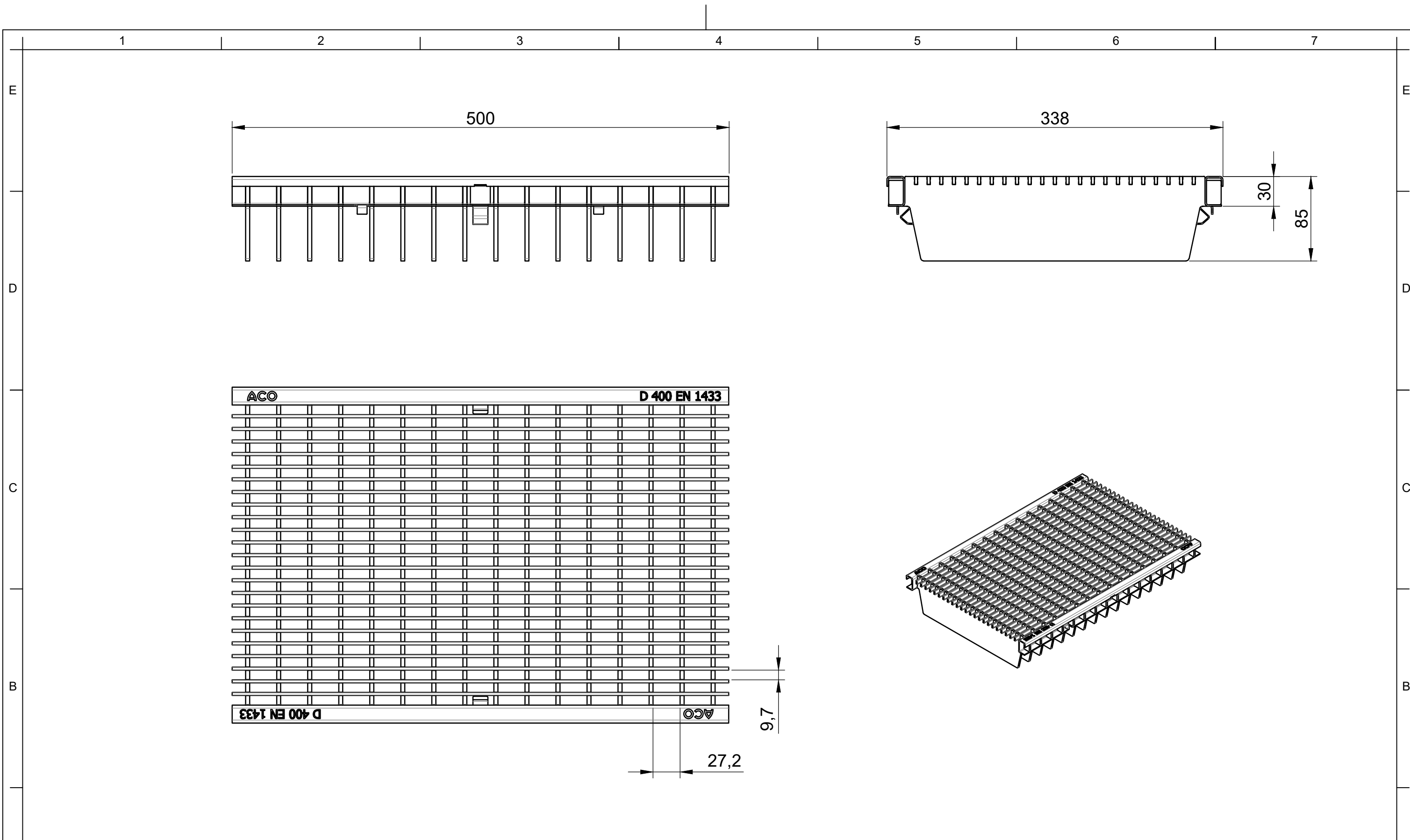

Inloopdoorsnede /  
absorption: 2028 cm<sup>2</sup>/m

Naam - Nom  
**Multiline V 300**  
 Q+ maasrooster - verzinkt staal kl. D 400 kN  
 (mazen / mailles 30x10 mm)  
 Q+ grille caillebotis - acier galvanisé cl. D 400 kN  
 Technische veranderingen voorbehouden - Sous réserve de changements techniques

	Name	Date
By	SB	21/11/19
Check	TS	21/11/19
Maten in millimeter		
Dimensions en millimètres		

	ACO Passavant NV/SA Preenakker 8 B - 1785 Merchtem	Tel.: 052/38.17.70 Fax.: 052/38.17.71 info@aco.be www.aco.be
	Artikel-Nr. - N° d'article 133676	Tekening Nr - Dessin n°

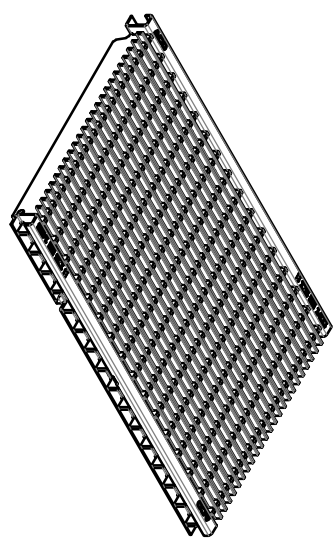
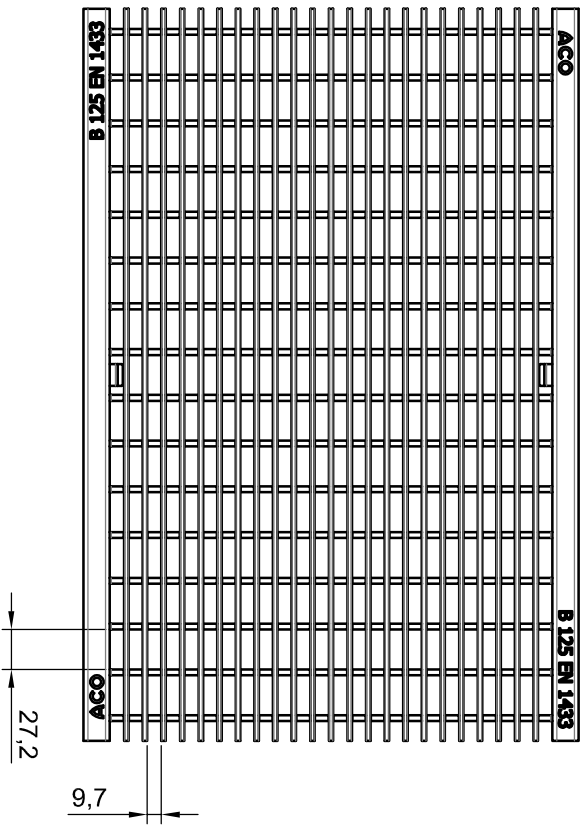
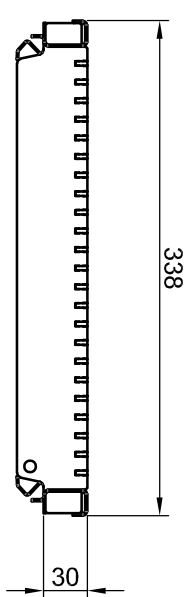
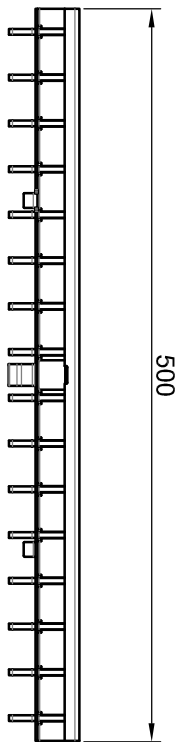

Inlooppdoorsnede /  
absorption: 2028 cm<sup>2</sup>/m

**Naam - Nom**  
Multiline V 300  
Q+ maasrooster uit roestvrij staal kl. B 125 KN  
(AISI 304, mazen / mailles 30x10 mm)  
Q+ grille caillaboits en acier inoxydable cl. B 125 KN

Name	Date
SB	23/05/19
TS	23/05/19



ACO Passavant NV/SA  
Pleerakker 8  
B - 1785 Merchtem

Tel.: 052/298.17.70  
Fax.: 052/238.17.71  
info@aco.be  
www.aco.be

Maten in millimeter

Artikel-Nr. - N° d'article  
133677

Tekening Nr - Dessin n°

Technische veranderingen voorbehouden - Sous réserve de changements techniques

Dimensions en millimètres

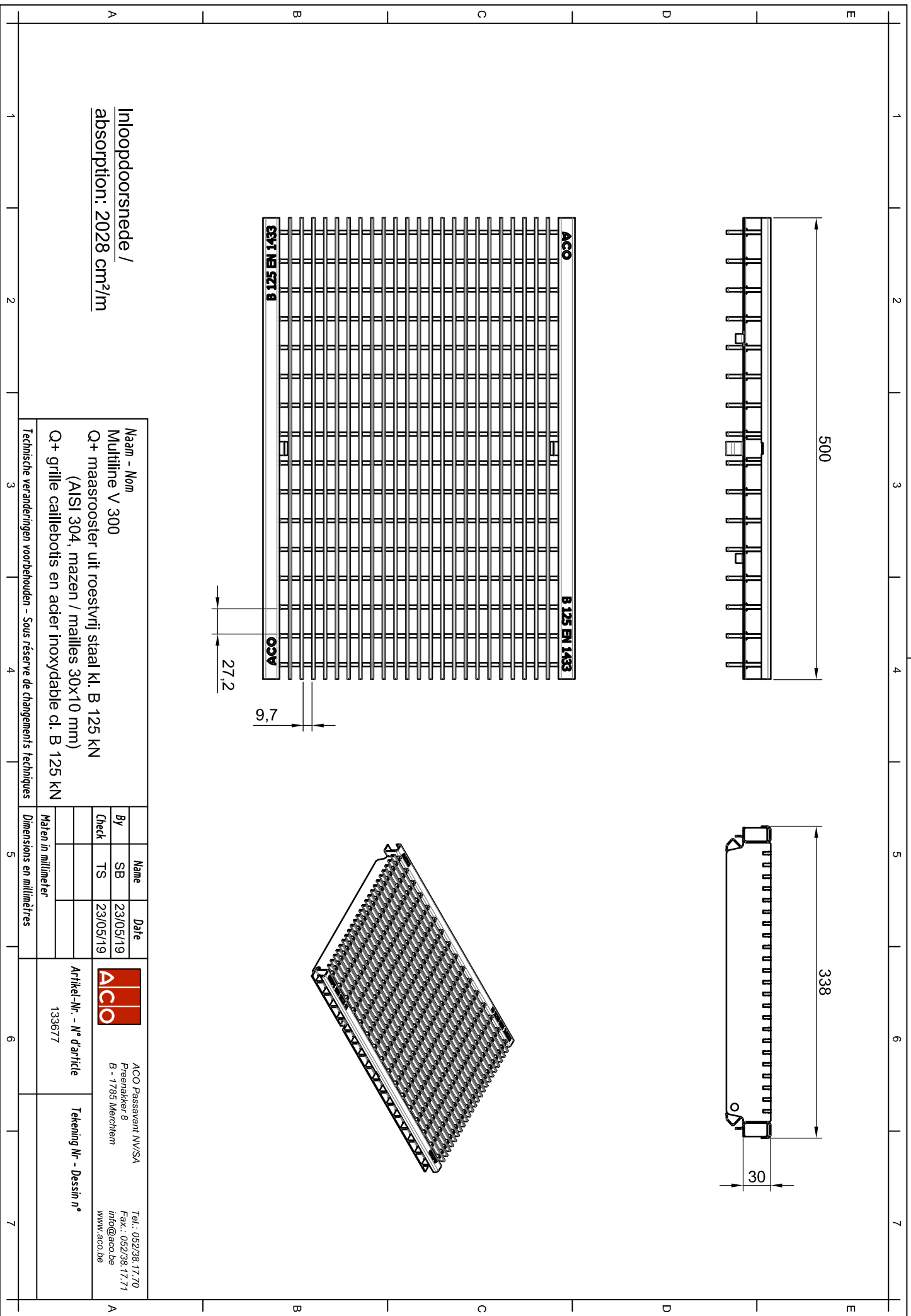

1 2 3 4 5 6 7

E  
D  
C  
B  
A

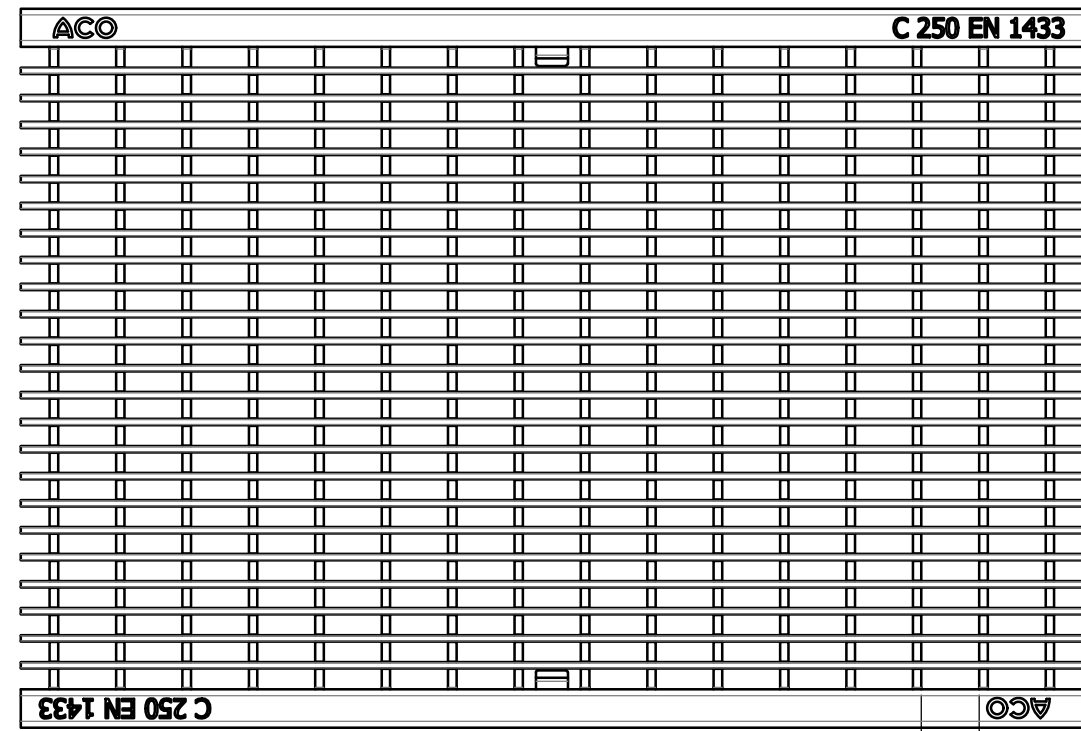
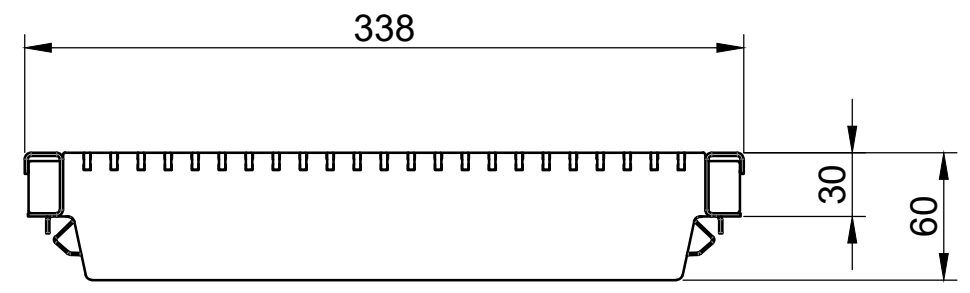
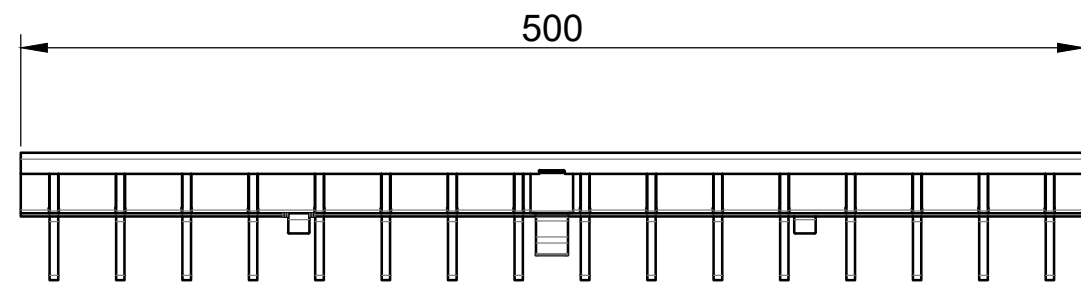

9,7

27,2

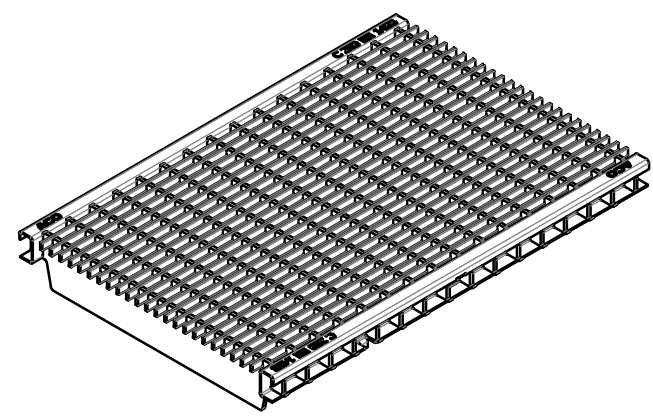

Inloopdoorsnede /  
absorption: 2028 cm<sup>2</sup>/m

Naam - Nom		Name	Date		ACO Passavant NV/SA Preenakker 8 B - 1785 Merchtem Tel.: 052/38.17.70 Fax.: 052/38.17.71 info@aco.be www.aco.be
Multiline V 300		By	21/11/19		
Q+ maasrooster uit roestvrij staal kl. C 250 kN (AISI 304, mazen / mailles 30x10 mm)		Check	21/11/19	Artikel-Nr. - N° d'article	
Q+ grille caillebotis en acier inoxydable cl. C 250 kN		Maten in millimeter		133678	
Technische veranderingen voorbehouden - Sous réserve de changements techniques		Dimensions en millimètres		Tekening Nr - Dessin n°	

1 2 3 4 5 6 7

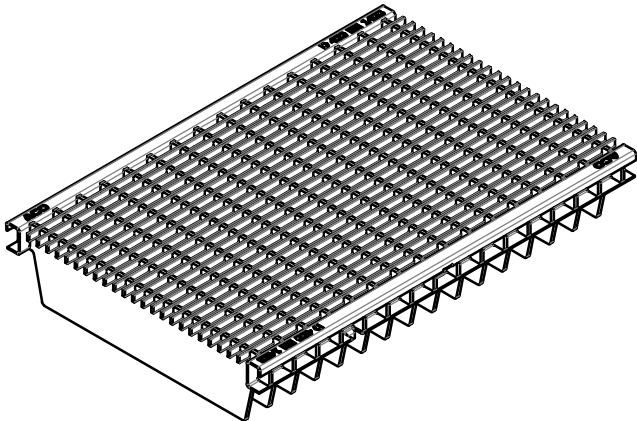
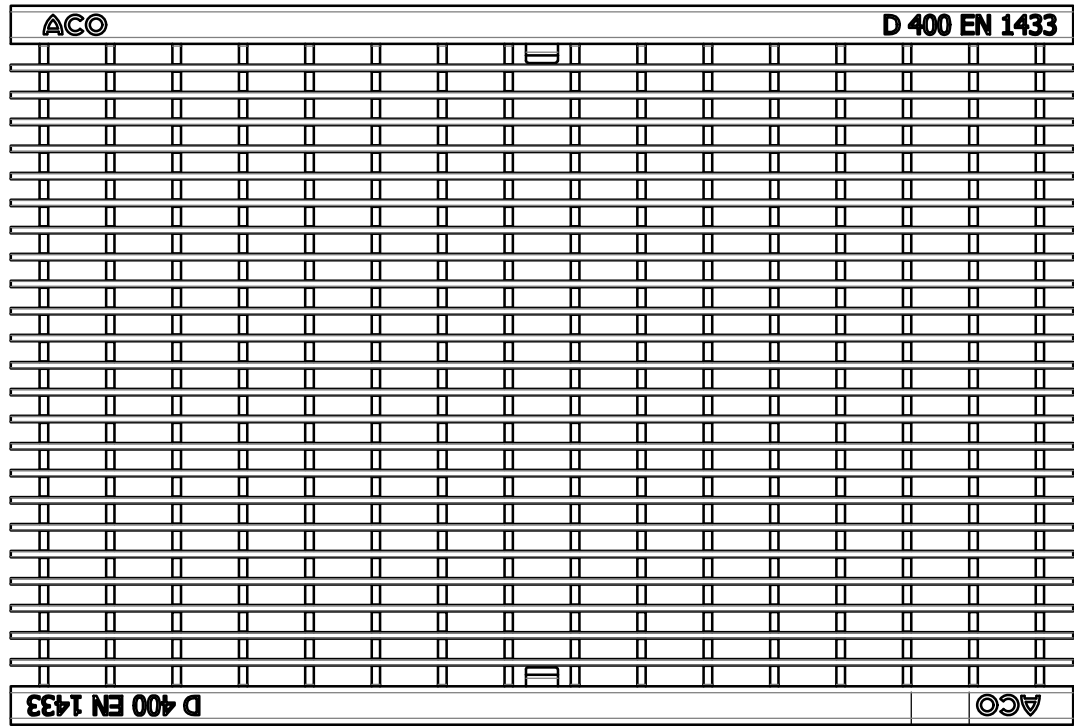
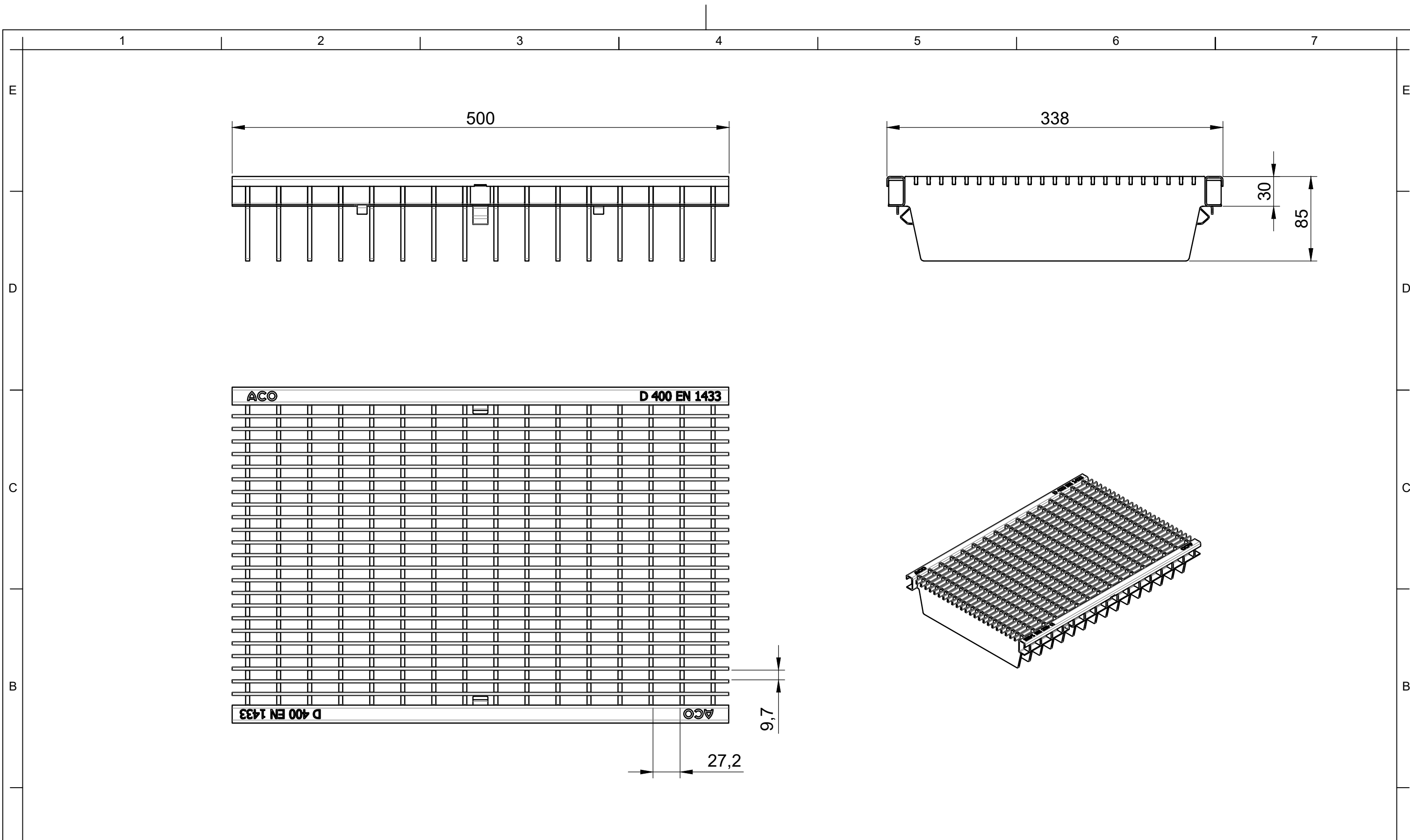

Inloopdoorsnede /  
absorption: 2028 cm<sup>2</sup>/m

Naam - Nom		Name	Date	 ACO Passavant NV/SA Preenakker 8 B - 1785 Merchtem Tel.: 052/38.17.70 Fax.: 052/38.17.71 info@aco.be www.aco.be	
Multiline V 300		By	SB		21/11/19
Q+ maasrooster uit roestvrij staal kl. D 400 kN (AISI 304, mazen / mailles 30x10 mm)		Check	TS		21/11/19
Q+ grille caillebotis en acier inoxydable cl. D 400 kN		Maten in millimeter		Artikel-Nr. - N° d'article	
Technische veranderingen voorbehouden - Sous réserve de changements techniques		Dimensions en millimètres		133679	
				Tekening Nr - Dessin n°	

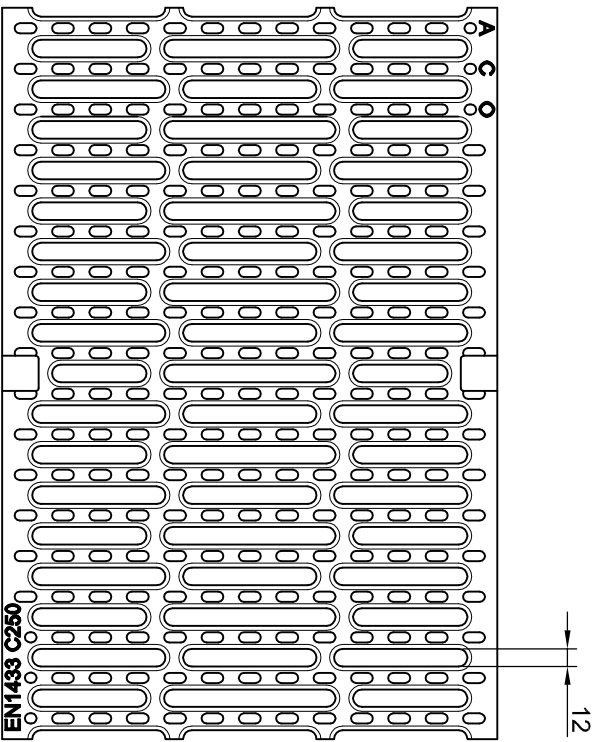
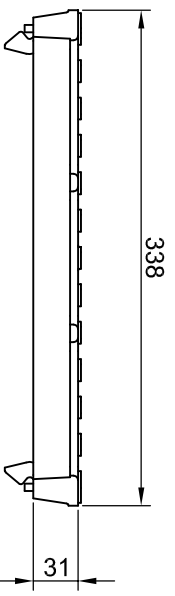
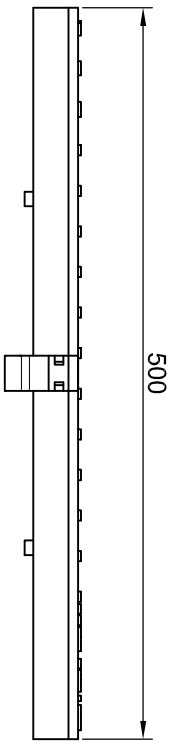

Inloopdoorsnede /  
absorption: 1146 cm<sup>2</sup>/m

**Naam - Nom**  
Multiiline V 300  
sleufrooster uit gietijzer kl. C 250 KN  
grille passerelle en fonte cl. C 250 KN

Technische veranderingen voorbehouden - Sous réserve de changements techniques

Maten in millimeter	
By	SB
Check	SW



ACO Passavant NV/SA  
Peebakkert 8  
B - 1785 Merchtem  
Tel.: 052/38.17.70  
Fax.: 052/38.17.71  
info@aco.be  
www.aco.be

Artikel-Nr. - N° d'article  
13870

Tekening Nr - Dessin n°

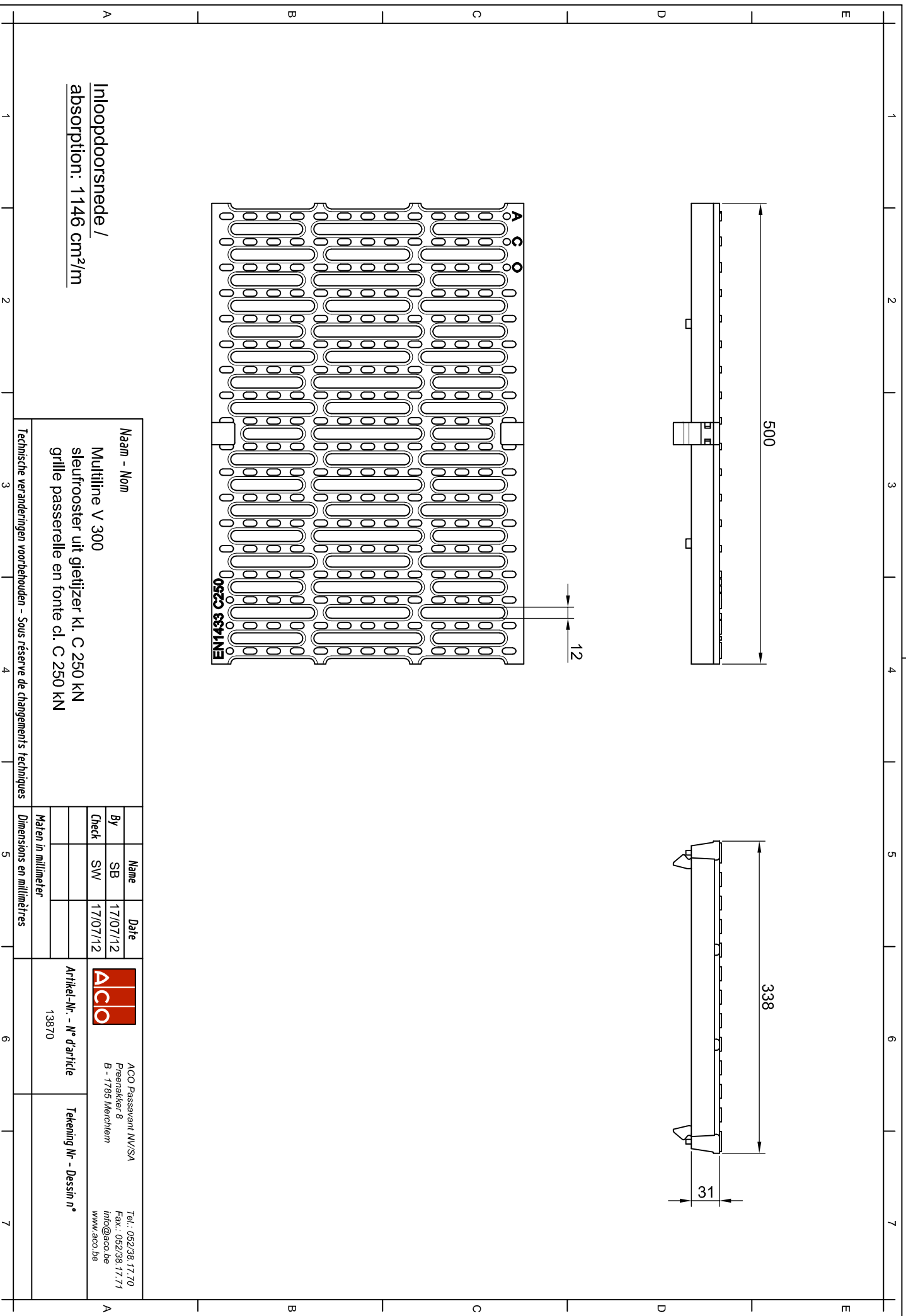



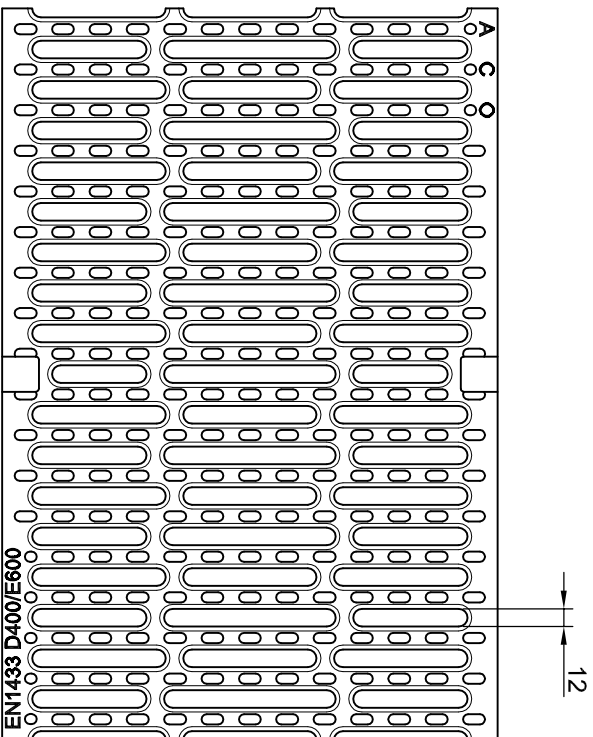
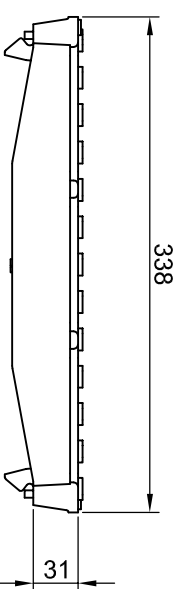
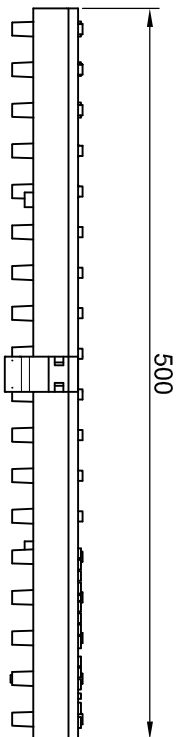

Inloopdoorsnede /  
absorption: 1146 cm<sup>2</sup>/m

**Multiiline V 300**  
sleufrooster uit gietijzer kl. D 400 / E 600 kN  
grille passerelle en fonte cl. D 400 / E 600 kN

Naam - Nom	
By	SB
Check	SW



ACO Passavant NV/SA  
Peeinikker 8  
B - 1785 Merchtem  
Tel.: 052/38.17.70  
Fax.: 052/38.17.71  
info@aco.be  
www.aco.be

Maten in millimeter	

Artikel-Nr. - N° d'article  
13871

Tekening Nr - Dessin n°

Technische veranderingen voorbehouden - Sous réserve de changements techniques

Dimensions en millimètres

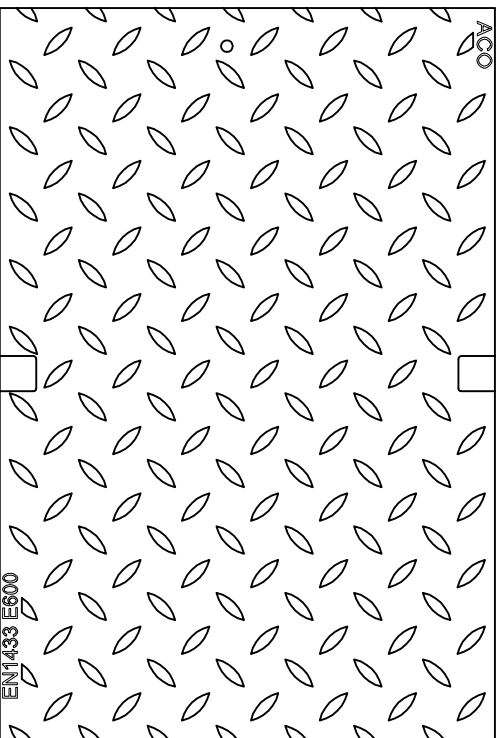
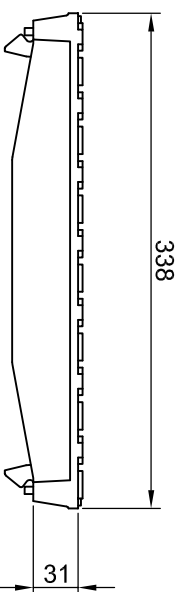
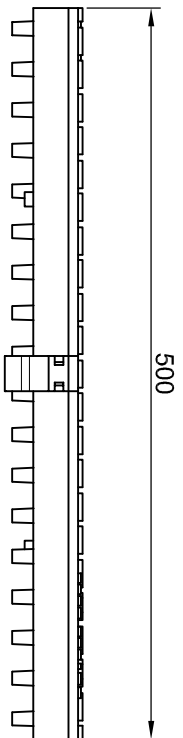

<b>Naam - Nom</b>		<b>Name</b>		<b>Date</b>			ACO Passavant NV/SA Peeenakker 8 B - 1785 Merchtem www.aaco.be	Tel.: 052/38.17.70 Fax.: 052/38.17.71 info@aaco.be
Multiiline V 300		By	SB	17/07/12				
afdekplaat uit gietijzer kl. D 400 / E 600 kN		Check	SW	17/07/12		Artikel-Nr. - N° d'article		Tekening Nr - Dessin n°
tôle larmée en fonte cl. D 400 / E 600 kN		Maten in millimeter		Dimensions en millimètres		13872		
Technische veranderingen voorbehouden - Sous réserve de changements techniques								

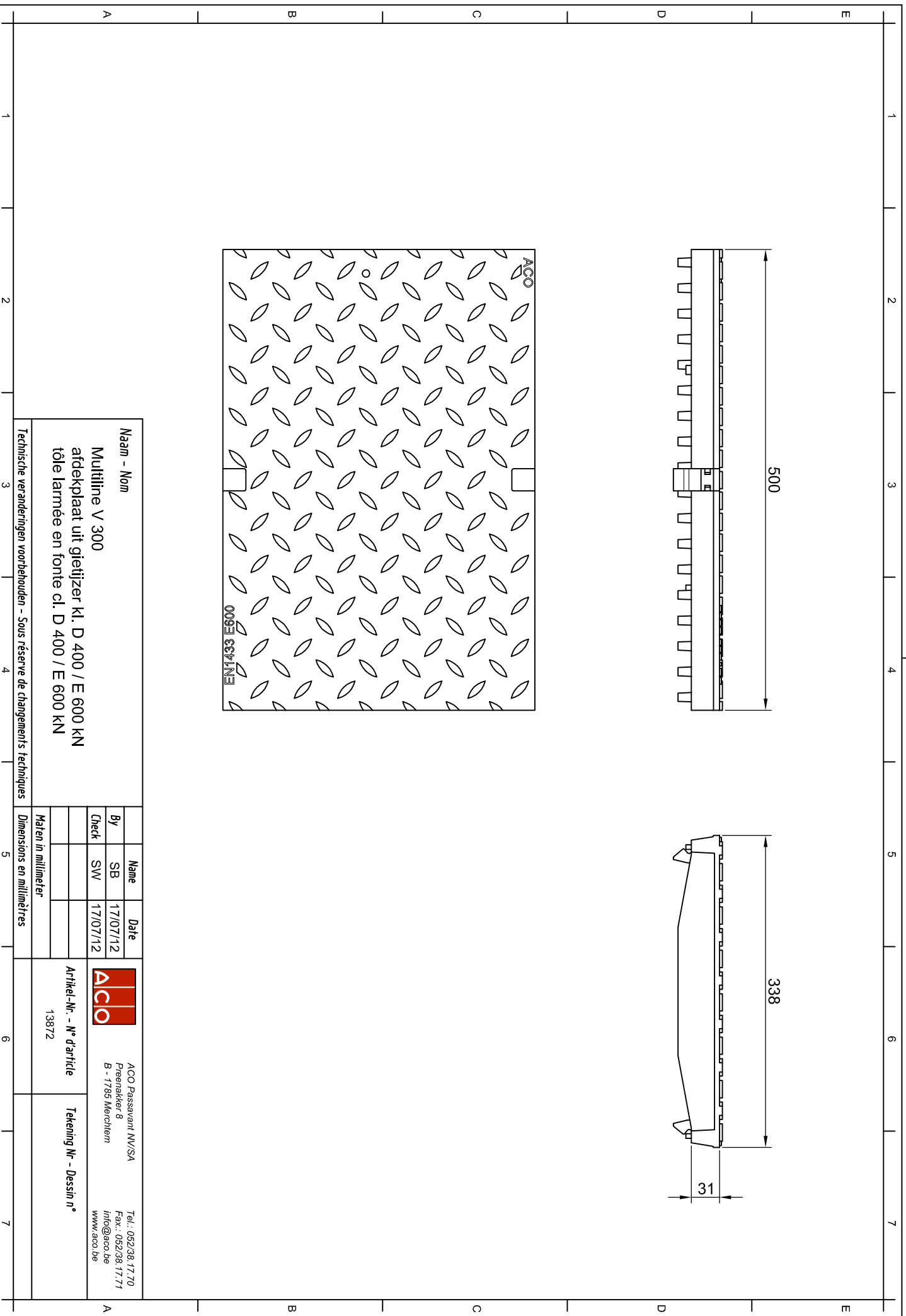

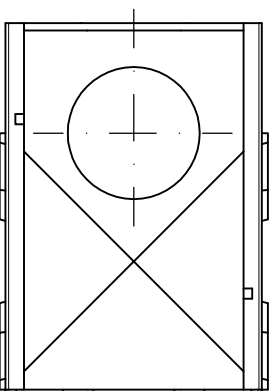
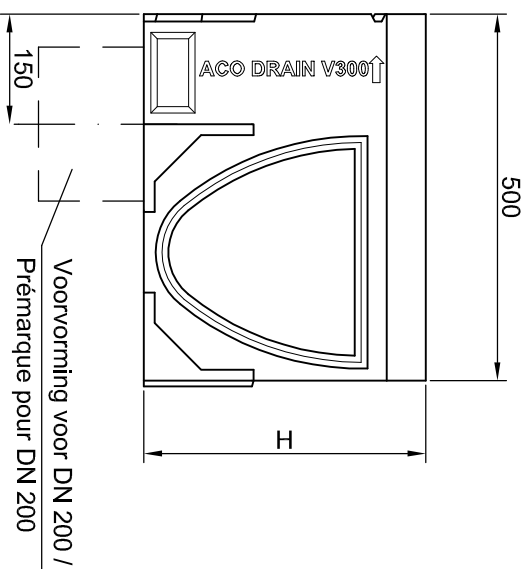
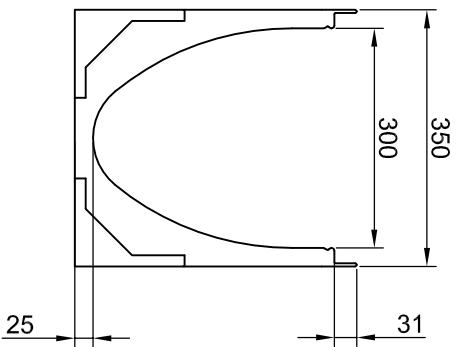

Randbescherming uit / Feuilure en				
Type	H (mm)	Verzinkt st./ Acier galva.	Roestvrij st./ Acier inox.	Gietijzer/ Fonte
0.1	385	13532	13632	13732
5.1	410	13542	13642	13742
10.1	435	13552	13652	13752
15.1	460	13562	13662	13762
20.1	485	13572	13672	13772

**Naam - Nom**  
**Multiline V 300 (0.1 - 20.1)**  
 voor middelzware belasting /  
 pour charges moyennes

Technische veranderingen voorbehouden - Sous r serve de changements techniques

By	Name	Date
SB	SB	17/07/12
Check	SW	17/07/12

Maten in millimeter

Dimensions en millim tres



ACO Passavant NV/SA  
 Peenakker 8  
 B - 1785 Merchtem  
 Tel.: 052/38.17.70  
 Fax.: 052/38.17.71  
 info@aco.be  
 www.aco.be

Artikel-Nr. - N  d'article  
 zie tabel / voir tableau

Tekening Nr - Dessin n 

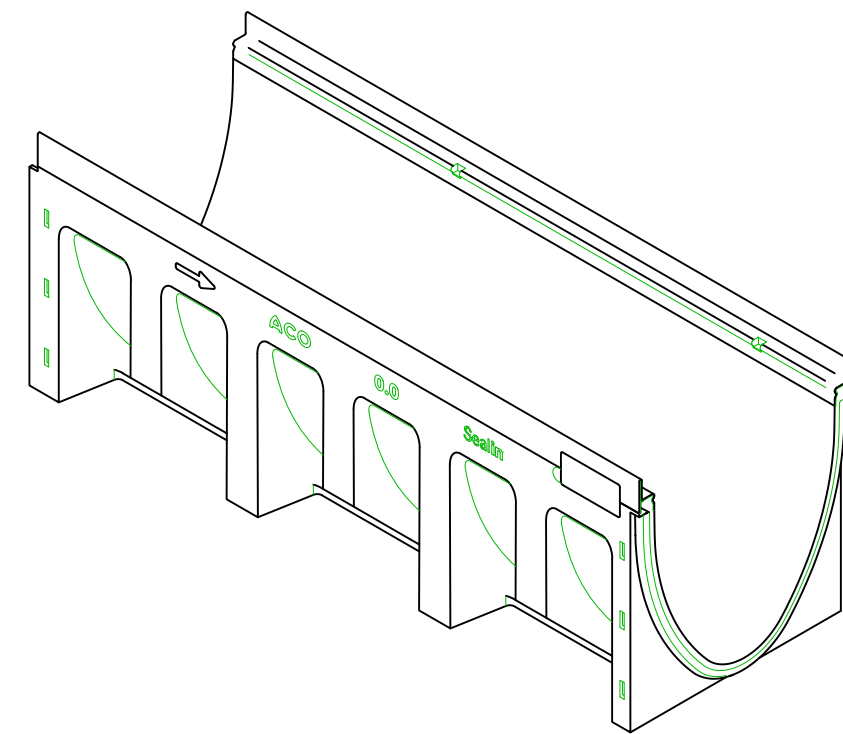
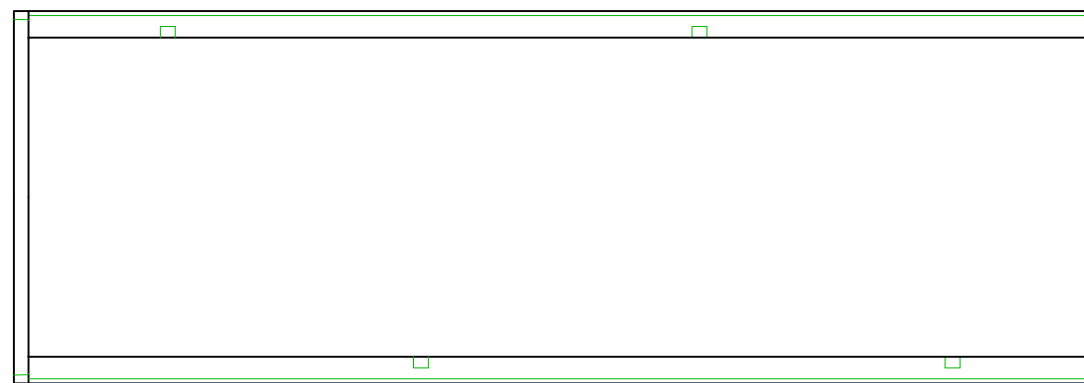
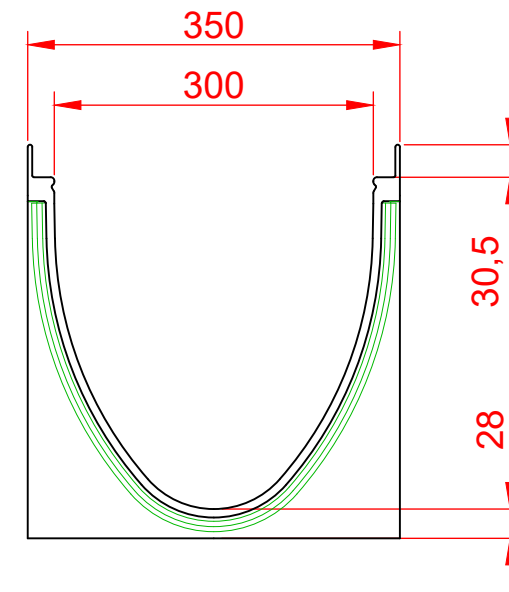
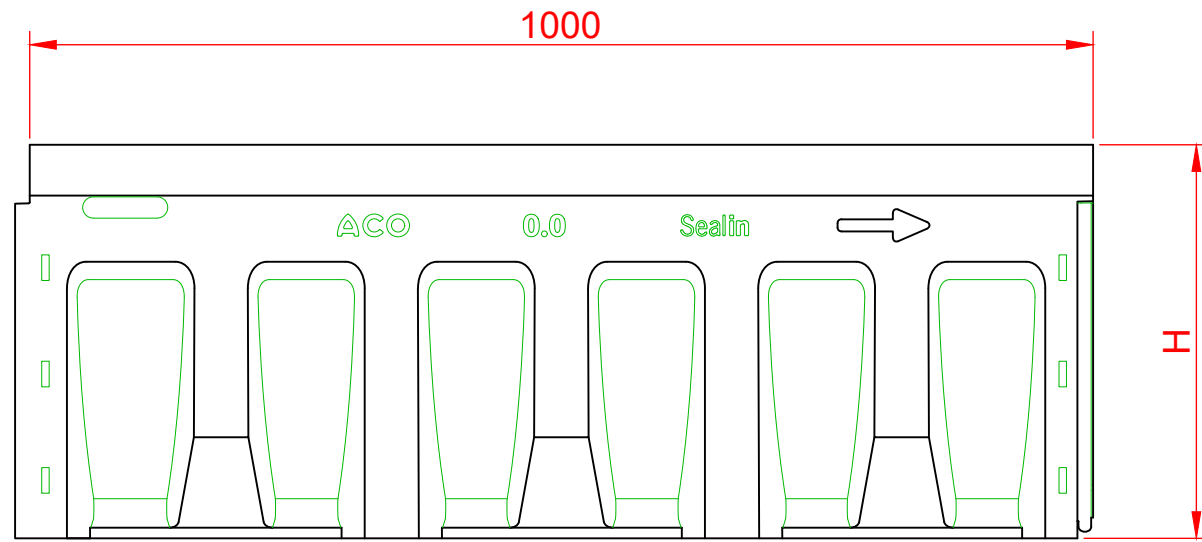

		Randbescherming uit / Feuillure en	
Type	H (mm)	Verzinkt st./ Acier galva.	Roestvrij st./ Acier inox.
0.0	370	153330	153430
10.0	420	153350	153450
20.0	470	153370	153470

**Multiline V 300 S "Seal in" (0.0 - 20.0)**

met geïntegreerde EPDM-afdichting thv tand/groef  
avec joint EPDM incorporé à la connexion mâle/fem.

belastingsklasse A15 - E600 classe de résistance

Technische veranderingen voorbehouden - Sous réserve de changements techniques

	Name	Date
By	SB	17/08/21
Check	DA	17/08/21
Maten in millimeter		
Dimensions en millimètres		



ACO Passavant NV/SA  
Preenakker 8  
B - 1785 Merchtem  
Tel.: 052/38.17.70  
Fax.: 052/38.17.71  
info@aco.be  
www.aco.be

Artikel-Nr. - N° d'article  
zie tabel / voir tableau

Tekening Nr - Dessin n°