

Art.-Nr. 11192

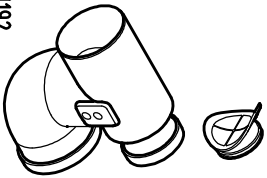

Art.-Nr. 11386

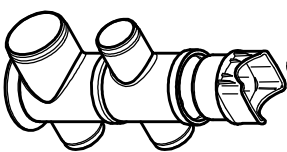

Art.-Nr. 11191

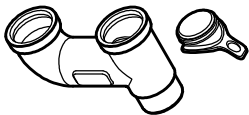

ZU Art.-Nr. 11386



**Benennung:**  
 ACO Xtradrain X 150 C Kunststoffrinne mit Ablauf-  
 schacht, Ablaufadapter DN/OD 160 und Eimer  
 Art.-Nr. 11011,11386,11191,11192

Datum	Name
18.02.2009	debeling
30.06.2011	debeling
Norm	



**ACO Tiefbau**

ACO Tiefbau Vertrieb GmbH  
 2455 Rendsburg, Postfach 309  
 Tel. 04331 / 354-500  
 Fax 04331 / 354-358  
 www.aco-tiefbau.de

Zeichnung-Nr.  
**G1-M01-1225-3**

Technische Änderungen vorbehalten

Schutzvermerk gemäß DIN 34

Ers. für:

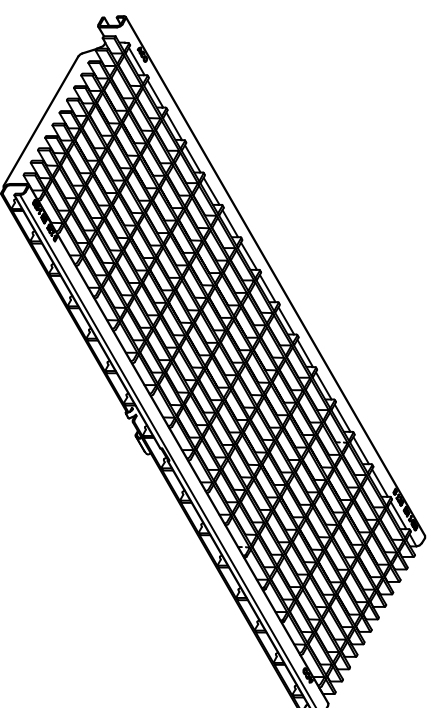
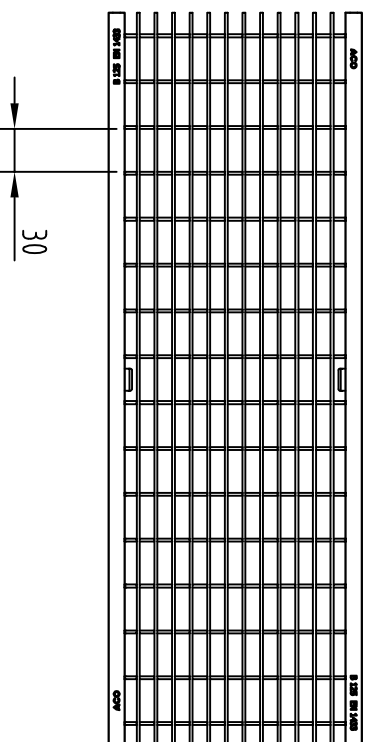
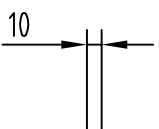
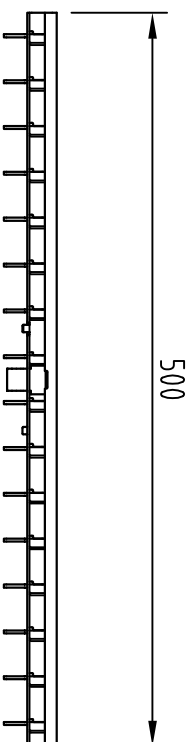
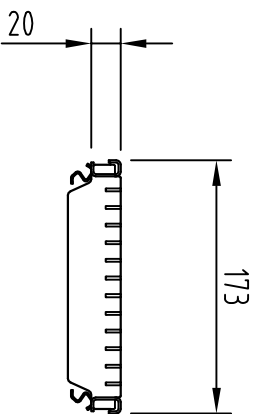
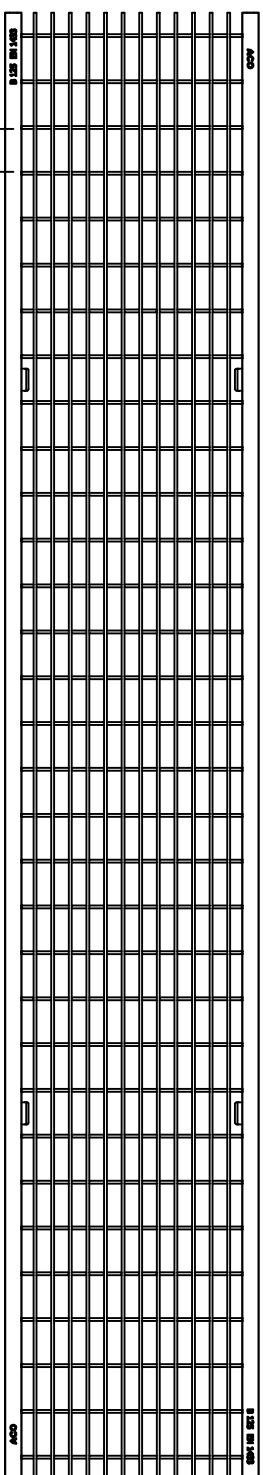
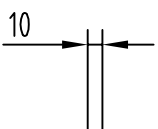
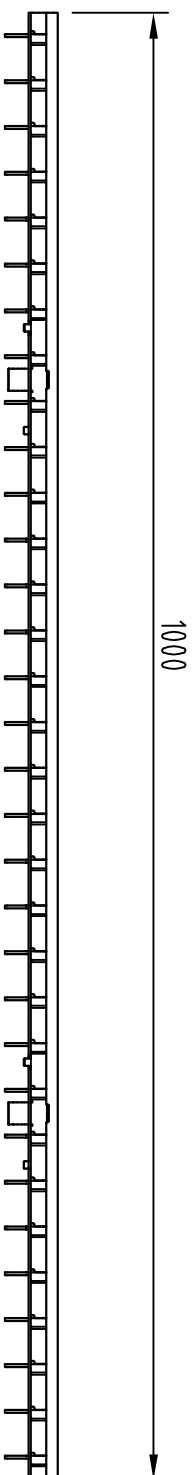
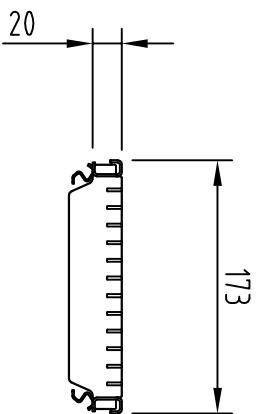

Rost	Stahl verzinkt	VZA
1,0 m	Art.-Nr. 133601	Art.-Nr. 133603
0,5 m	133602	133604

Benennung:  
 ACO DRAIN Multiline V 150 Maschenrost Q+, MW 30x10  
 VZA / Stahl verz., Kl. B125, L= 1,0 m / 0,5 m  
 Art.-Nr. 133601, 133602, 133603, 133604

Gez.	Datum	Name
09.02.2017		debeling
Upr.		
Norm		

ACO Tiefbau Vertrieb GmbH  
 24755 Bending, Postfach 209  
 Tel. 04331 / 351-500  
 FAX 04331 / 351-539  
 www.aco-tiefbau.de

Zeichnung-Nr.  
 G1-M01-1563-3

Index  
 000

Schutzvermerk gemäß DIN 34

Ers. für:

Technische Änderungen vorbehalten

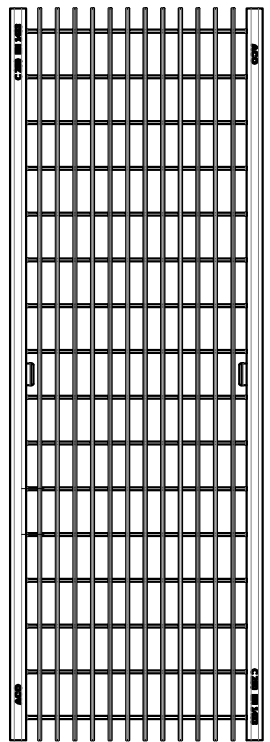
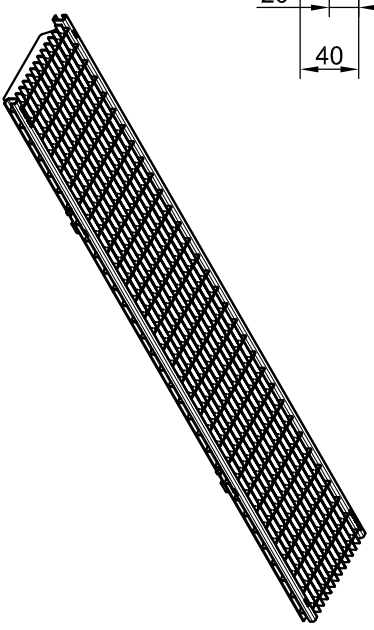
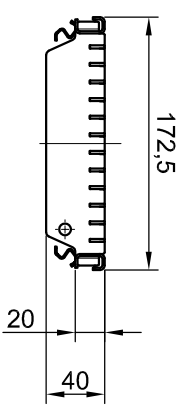
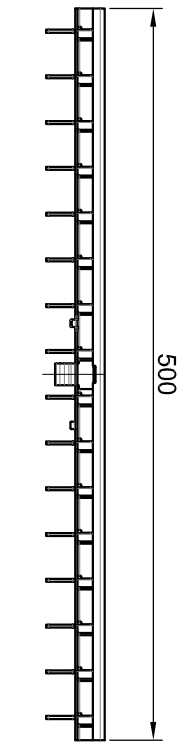
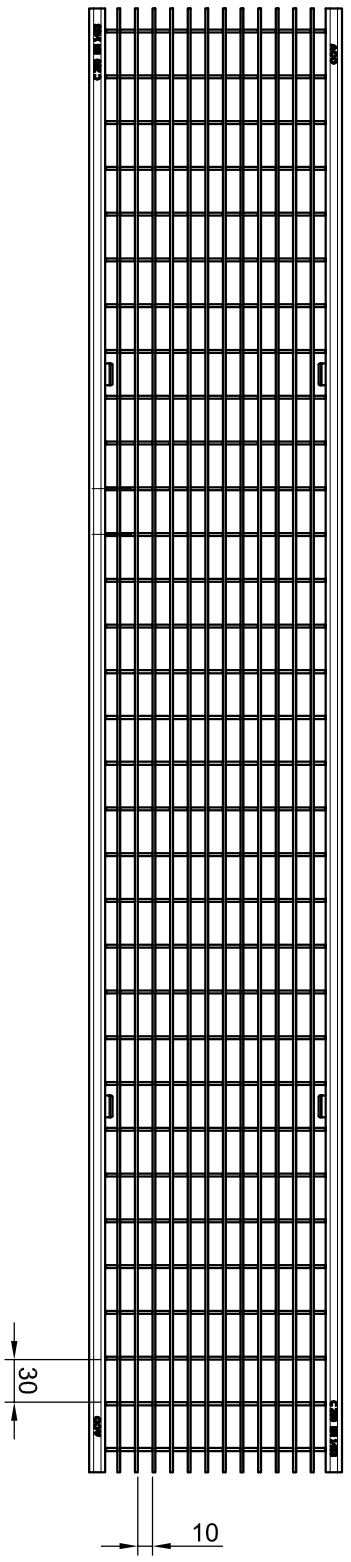
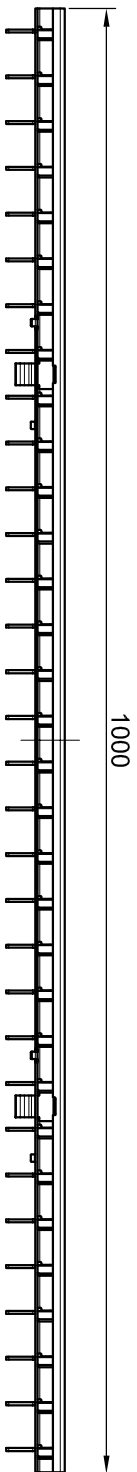

Inloopdoorsnede /  
absorption: 1182 cm<sup>2</sup>/m

<b>Naam - Nom</b> <b>Multiline V 150</b> Q+ maastrooster uit verzinkt staal kl. C 250 KN (mazen / mailles 30x10 mm) Q+ grille caillabois en acier galvanisé cl. C 250 KN		<b>Name</b> SB TS		<b>Date</b> 20/09/17 20/09/17			ACO Passavant NV/SA Peenrikker 8 B - 1785 Merchtem	Tel.: 052/38.17.70 Fax: 052/38.17.71 info@aco.be www.aco.be
<b>Technische veranderingen voorbehouden - Sous réserve de changements techniques</b>		<b>Maten in millimeter</b>		<b>Artikel-Nr. - N° d'article</b> 133605 (1 m) 133606 (0,5 m)				

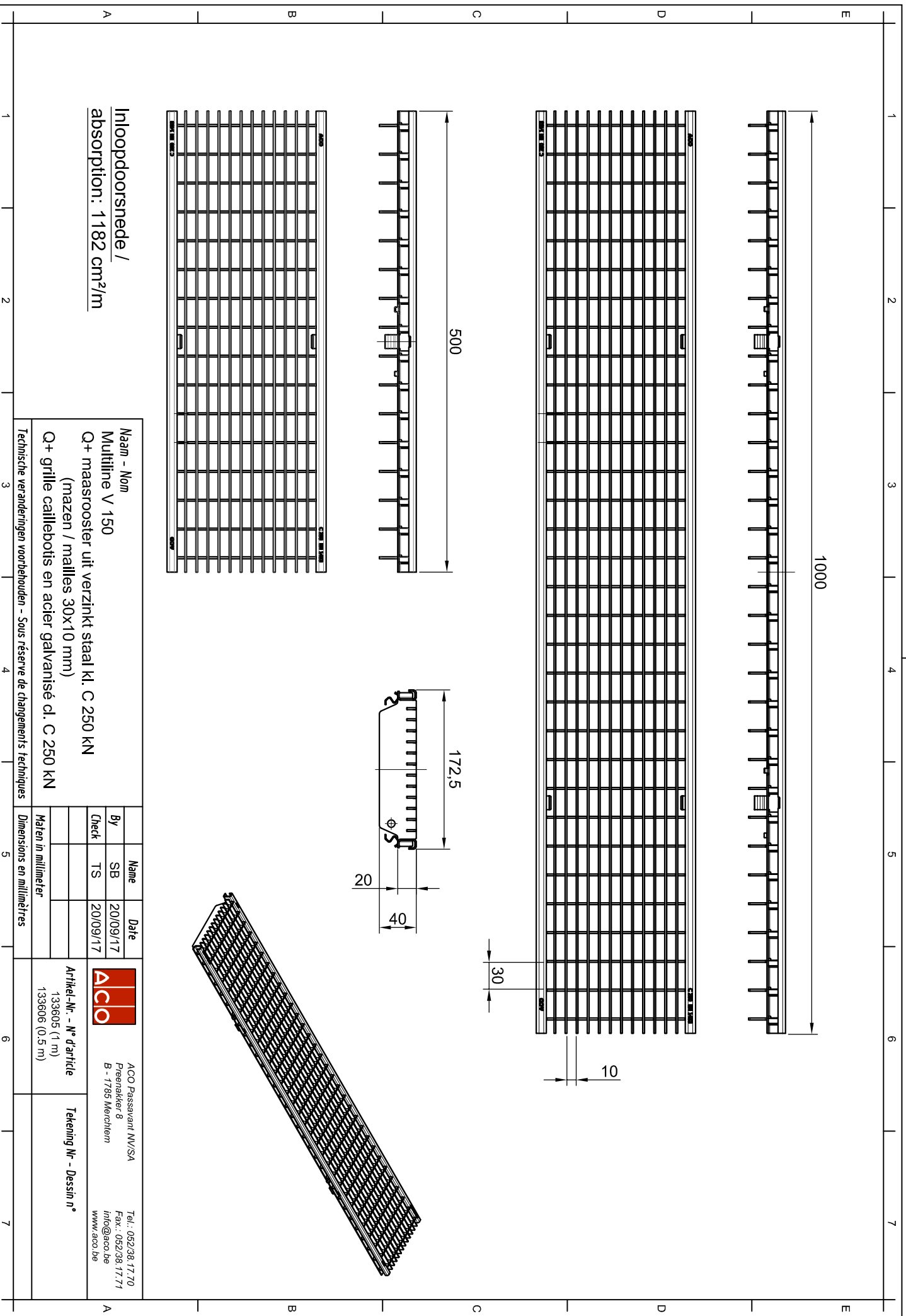

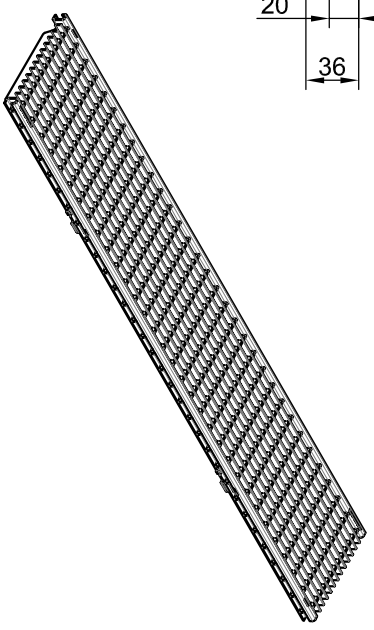
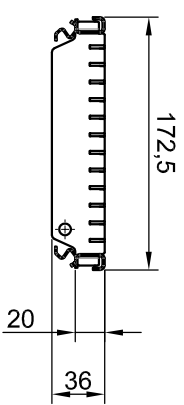
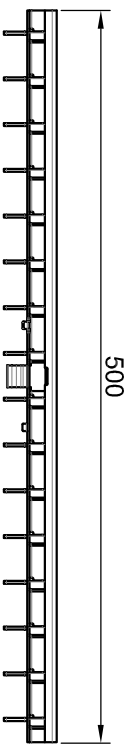
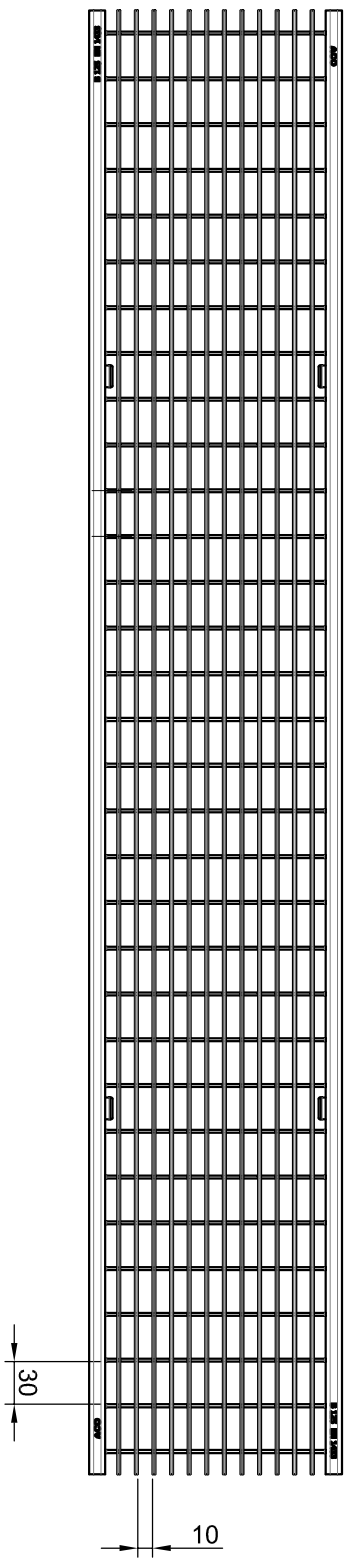
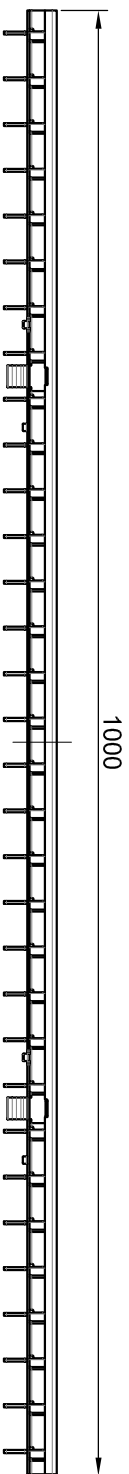

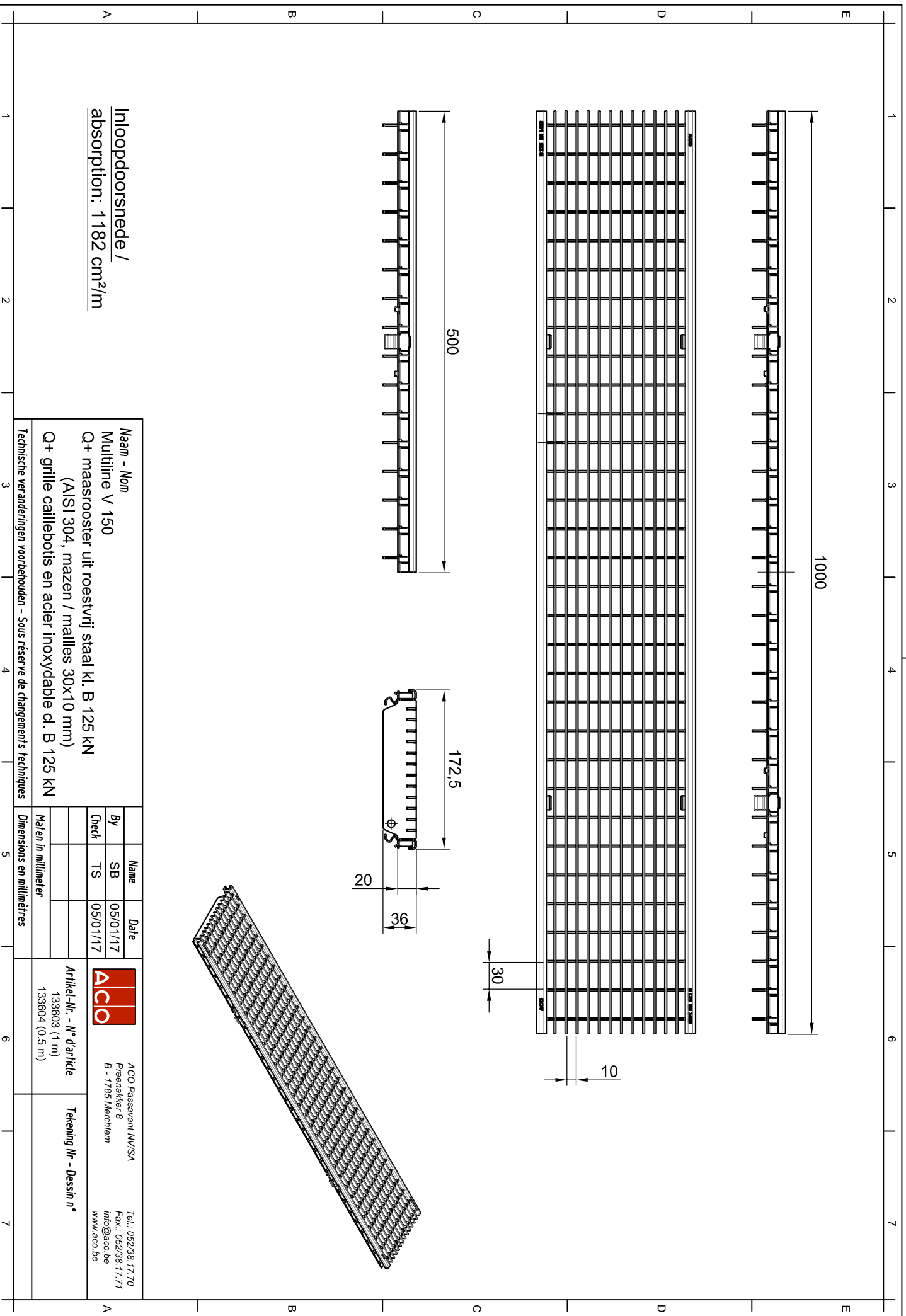

Inloopdoorsnede /  
absorption: 1182 cm<sup>2</sup>/m

<b>Naam - Nom</b> Multiline V 150 Q+ maastrooster uit roestvrij staal kl. B 125 kN (AISI 304, mazen / mailles 30x10 mm) Q+ grille caillaboits en acier inoxydable cl. B 125 kN		<b>Name</b> SB TS		<b>Date</b> 05/01/17 05/01/17			ACO Passavant NV/SA Peenakker 8 B - 1785 Merchtem Tel.: 052/38.17.70 Fax: 052/38.17.71 info@aco.be www.aco.be
<b>Technische veranderingen voorbehouden - Sous réserve de changements techniques</b>		<b>Maten in millimeter</b>		<b>Artikel-Nr. - N° d'article</b> 133603 (1 m) 133604 (0,5 m)			

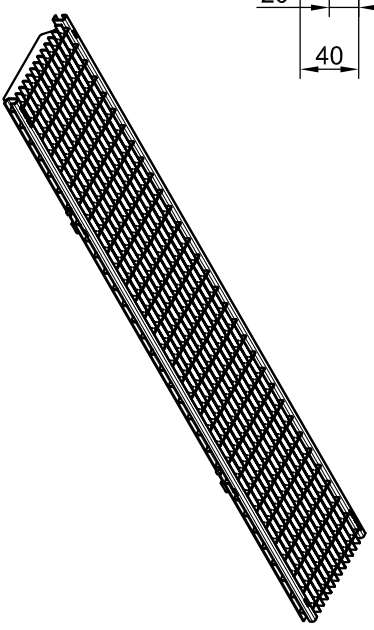
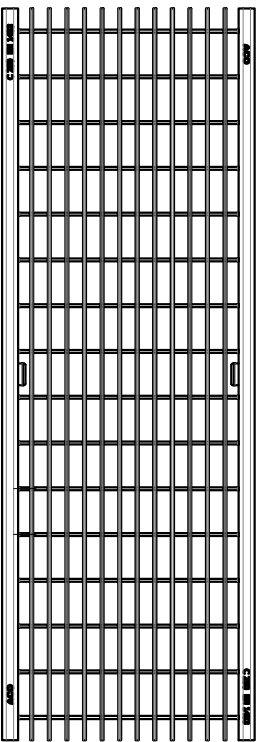
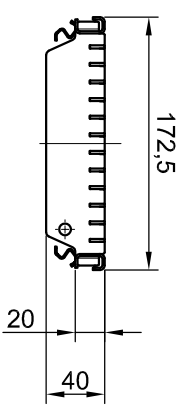
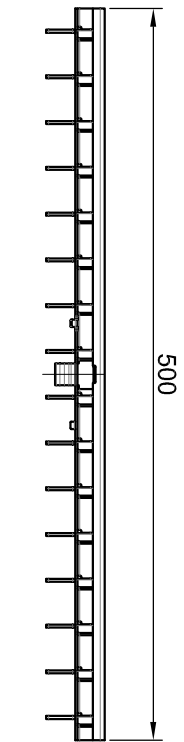
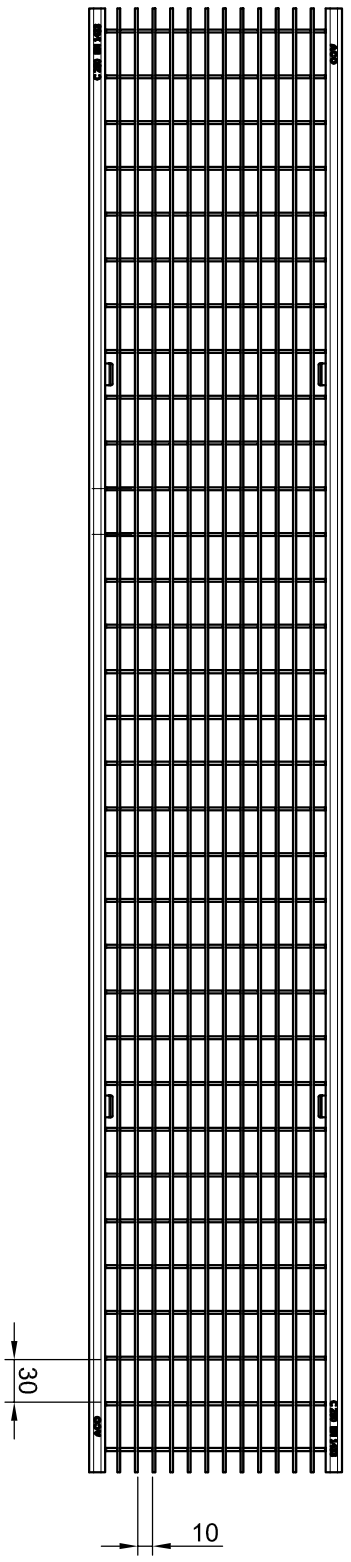
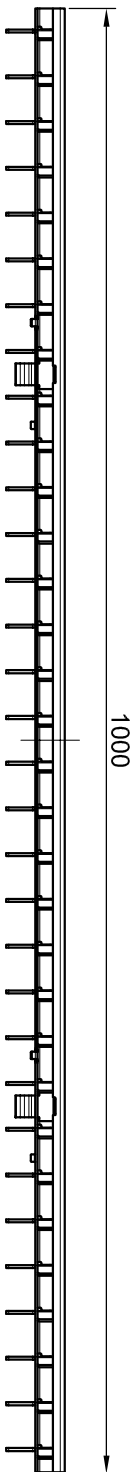



Inloopdoorsnede /  
absorption: 1182 cm<sup>2</sup>/m

<b>Naam - Nom</b> Multiline V 150 Q+ maasrooster uit roestvrij staal kl. C 250 kN (AISI 304, mazen / mailles 30x10 mm) Q+ grille caillaboits en acier inoxydable cl. C 250 kN		<b>Name</b> SB TS		<b>Date</b> 20/09/17 20/09/17			ACO Passavant NV/SA Peenrikker 8 B - 1785 Merchtem	Tel.: 052/38.17.70 Fax.: 052/38.17.71 info@aco.be www.aco.be
<b>Technische veranderingen voorbehouden - Sous réserve de changements techniques</b>		<b>Maten in millimeter</b>		<b>Artikel-Nr. - N° d'article</b> 133607 (1 m) 133608 (0,5 m)				

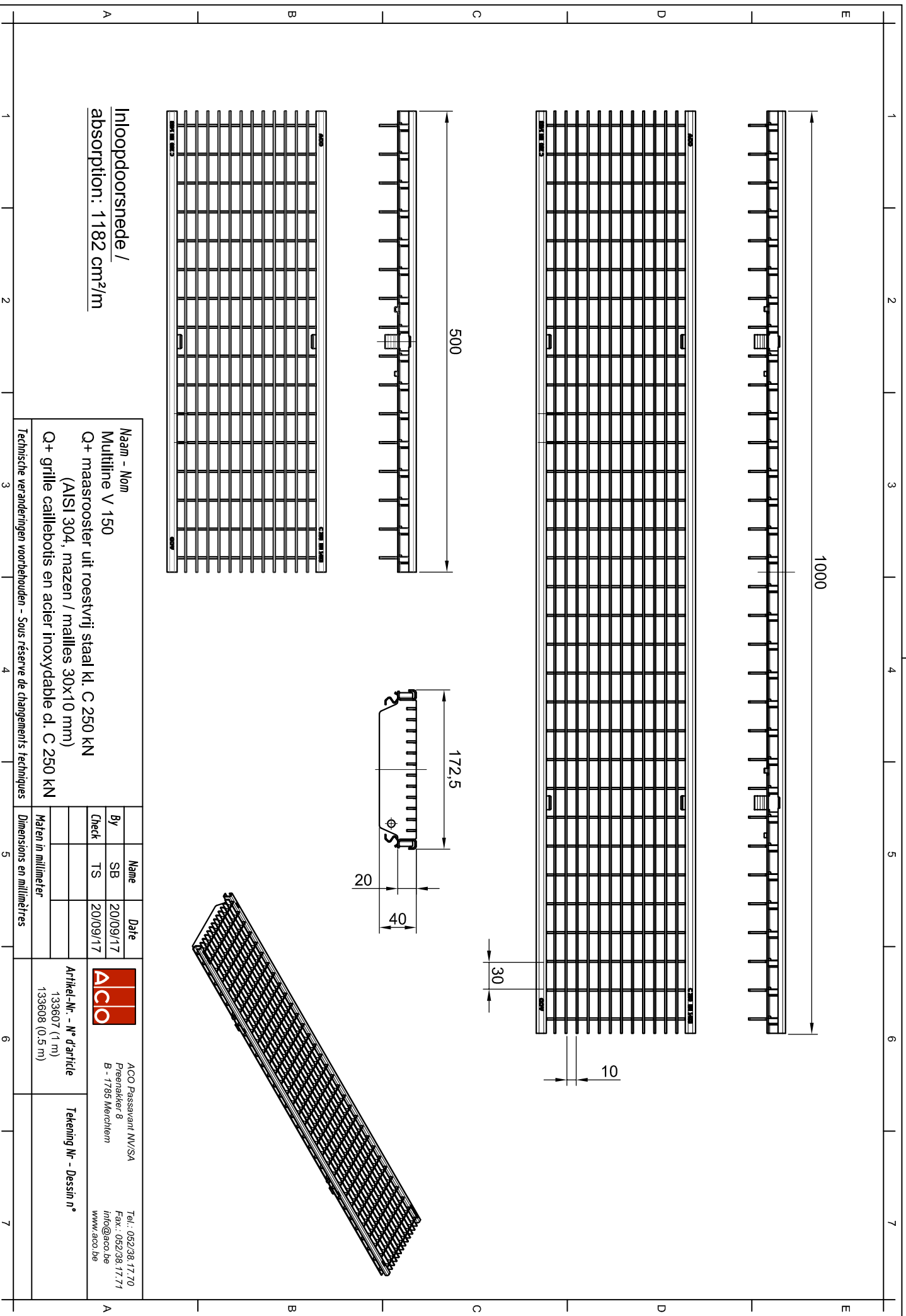

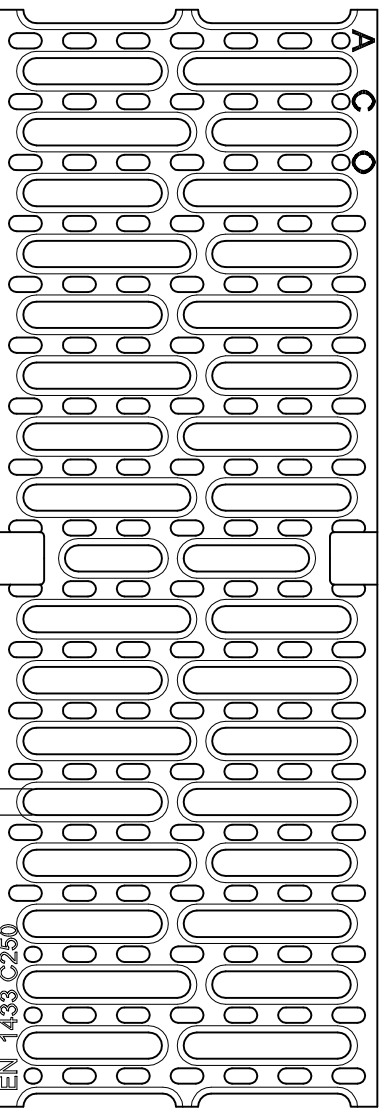
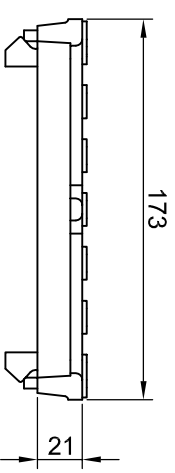
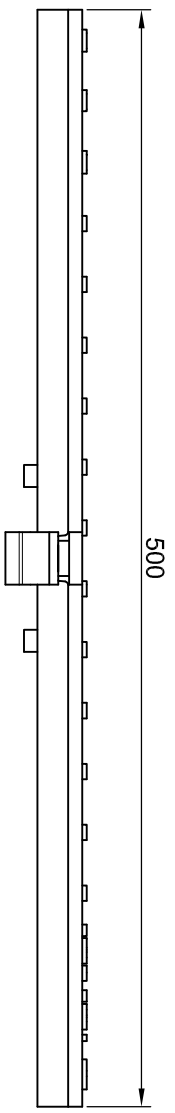

Inloopdoorsnede /  
absorption: 578 cm<sup>2</sup>/m

**Naam - Nom**  
Multiiline V 150  
sleufrooster uit gietijzer kl. C 250 KN  
grille passerelle en fonte cl. C 250 KN

*Technische veranderingen voorbehouden - Sous réserve de changements techniques*

	Name	Date
By	SB	18/07/12
Check	SW	18/07/12

Maten in millimeter

Dimensions en millimètres



Artikel-Nr. - N° d'article  
13070

ACO Passavant NV/SA  
Peeinikker 8  
B - 1785 Merchtem  
www.aco.be

Tel.: 052/38.17.70  
Fax: 052/38.17.71  
info@aco.be

Tekening Nr - Dessin n°

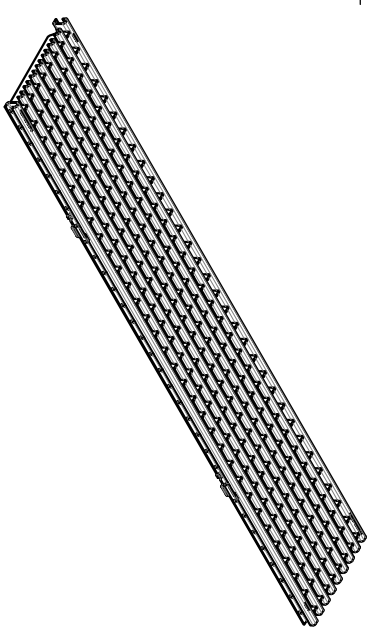
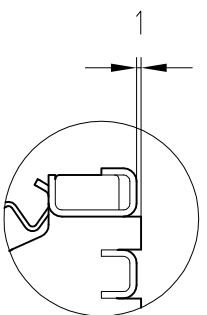
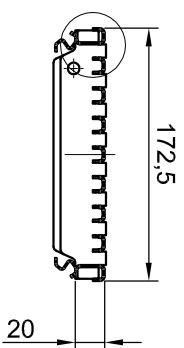
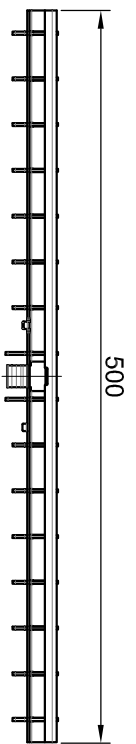
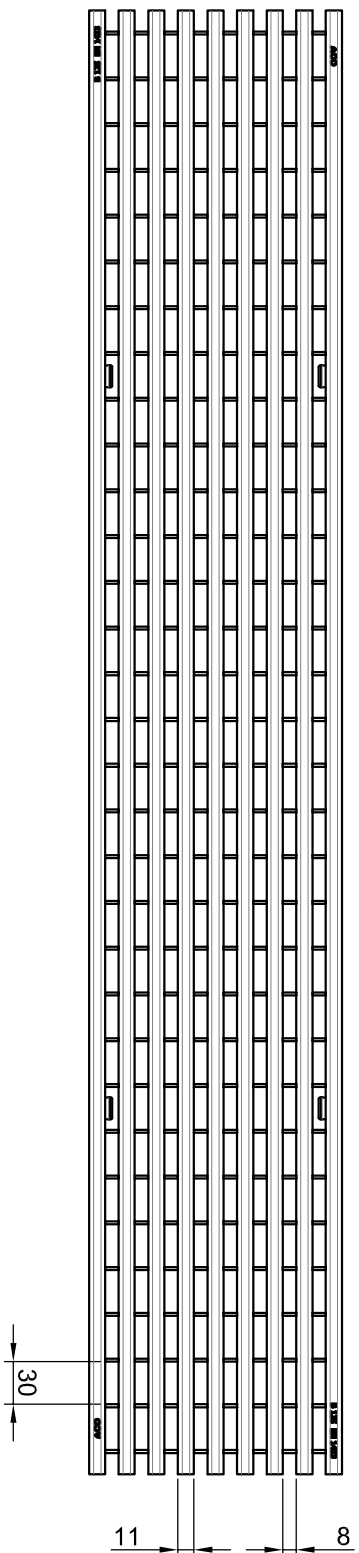
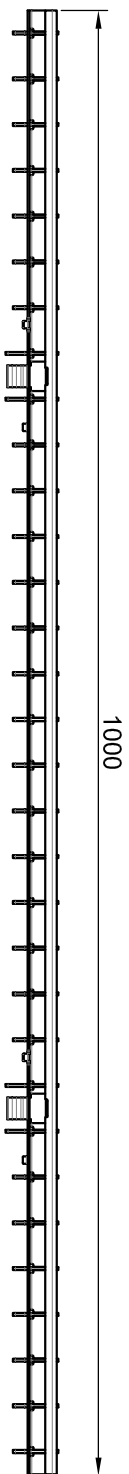

Inloopdoorsnede /  
absorption: 687 cm<sup>2</sup>/m

**Naam - Nom**  
Multiline V 150  
lengtestaafrooster uit verzinkt staal  
B 125 kN - profiel U profiel 8 mm  
grille passerelles longitudinales en acier galvanisé

*Technische veranderingen voorbehouden - Sous réserve de changements techniques*

Name	Date
By SB	05/01/17
Check TS	05/01/17



ACO Passavant NV/SA  
Peeenikker 8  
B - 1785 Merchtem  
Tel.: 052/38.17.70  
Fax: 052/38.17.71  
info@aco.be  
www.aco.be

Maten in millimeter	

Artikel-Nr. - N° d'article  
133625 (1 m)  
133626 (0,5 m)

Tekening Nr - Dessin n°

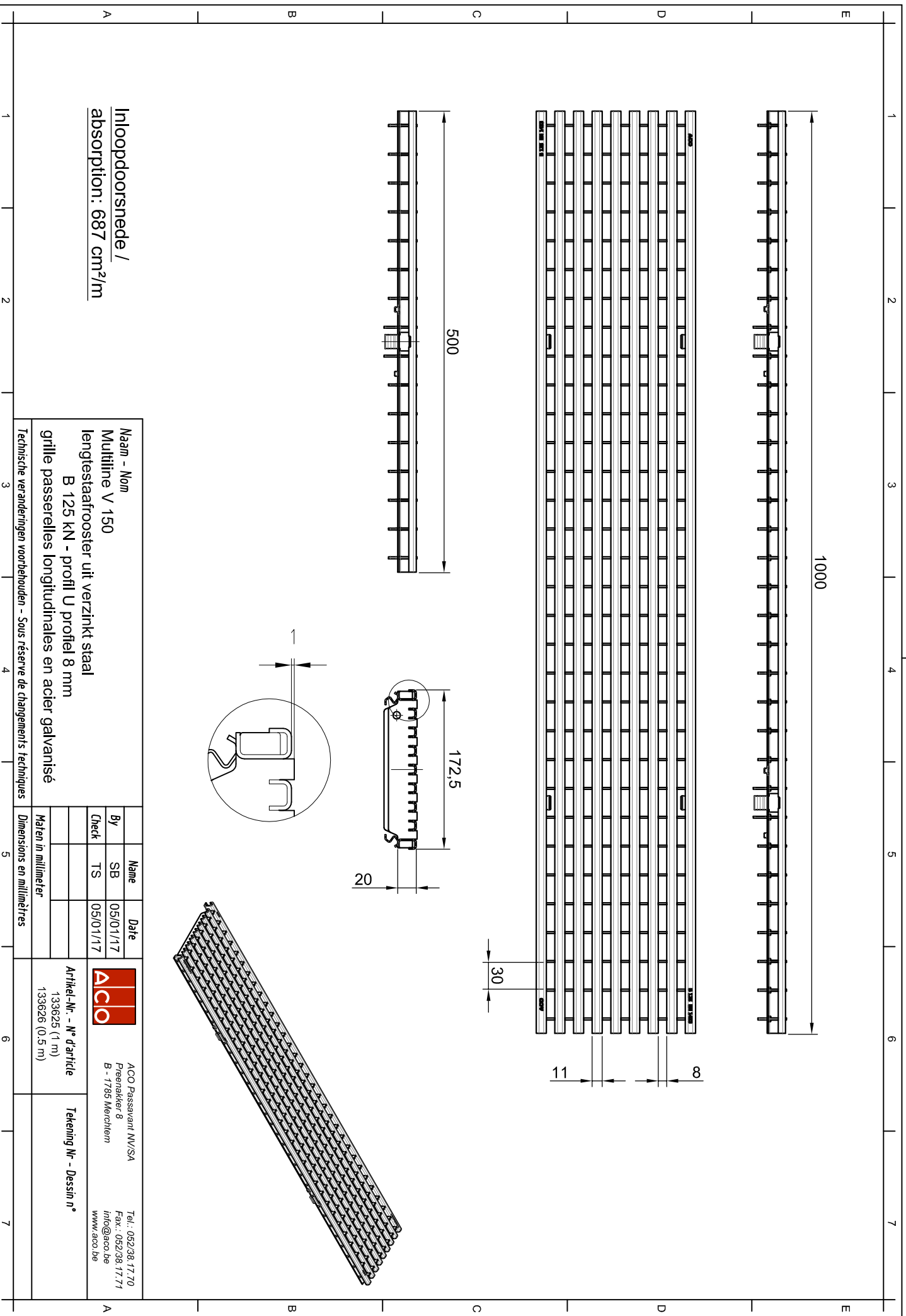

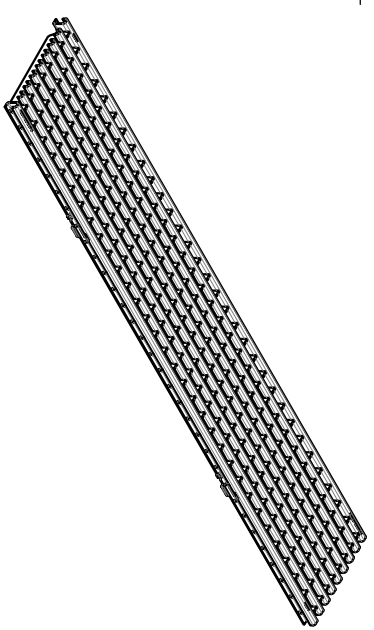
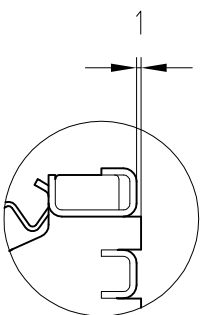
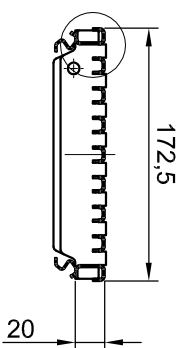
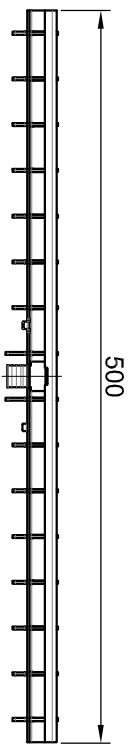
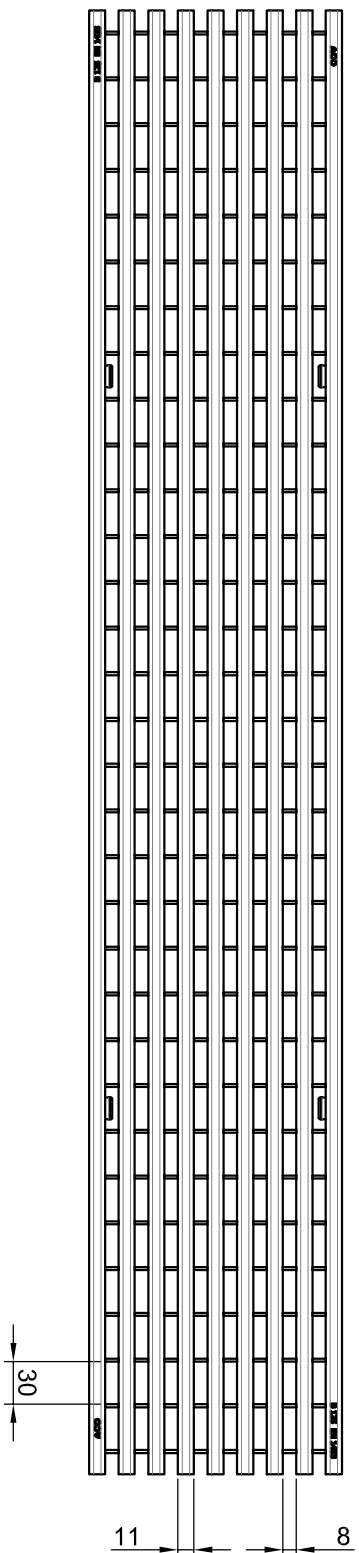
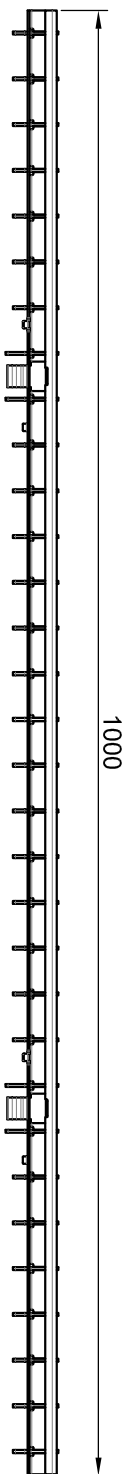

Inloopdoorsnede /  
absorption: 687 cm<sup>2</sup>/m

**Naam - Nom**  
Multiline V 150  
lengtestaafrooster uit roestvrij staal  
(AISI 304) - B 125 kN - profiel 8 mm  
grille passerelles longitudinales en acier Inoxydable

*Technische veranderingen voorbehouden - Sous réserve de changements techniques*

Name	Date
By SB	05/01/17
Check TS	05/01/17



ACO Passavant NV/SA  
Peeenikker 8  
B - 1785 Merchtem  
Tel.: 052/38.17.70  
Fax.: 052/38.17.71  
info@aco.be  
www.aco.be

Maten in millimeter	

Artikel-Nr. - N° d'article  
133627 (1 m)  
133628 (0,5 m)

Tekening Nr - Dessin n°

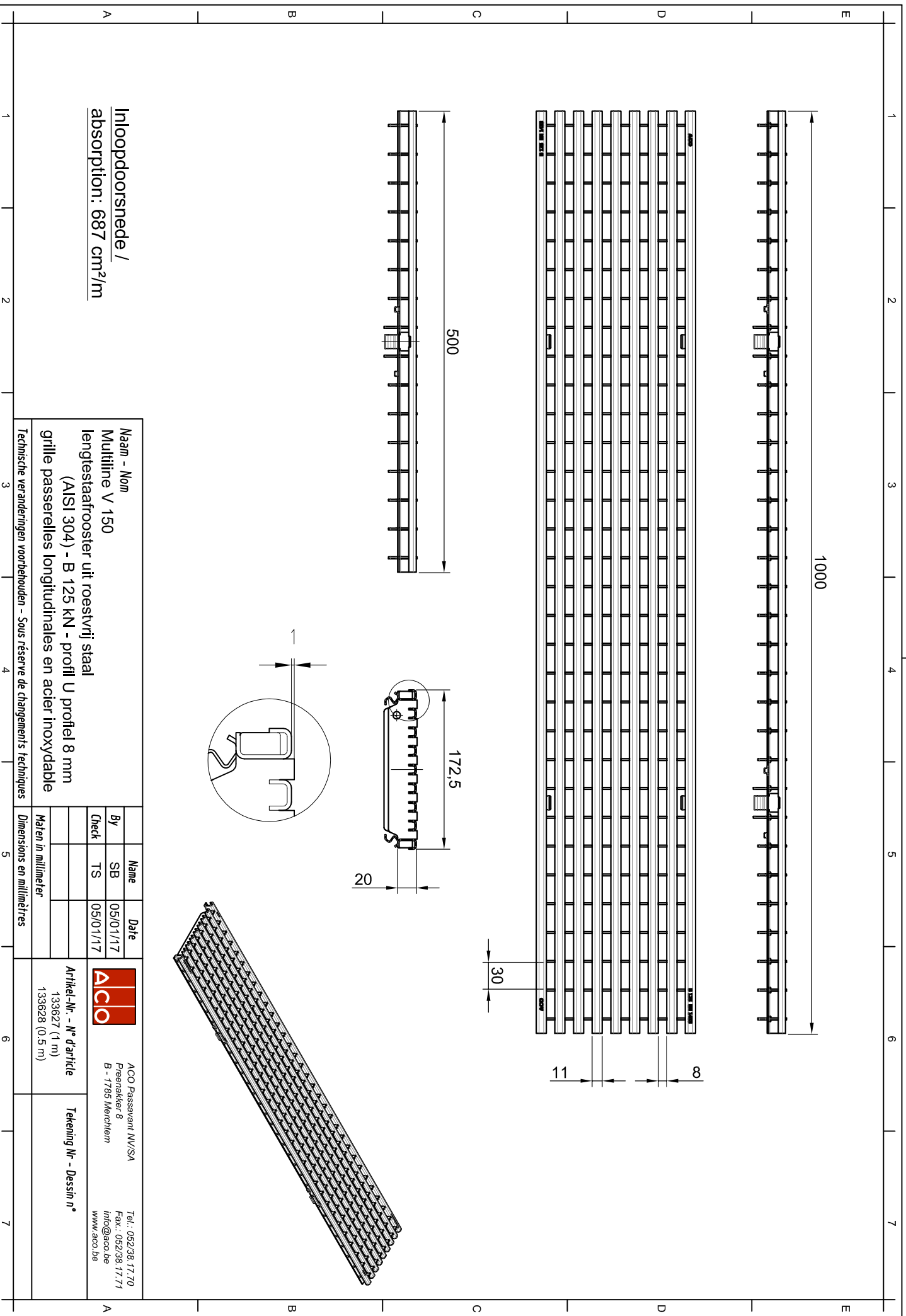



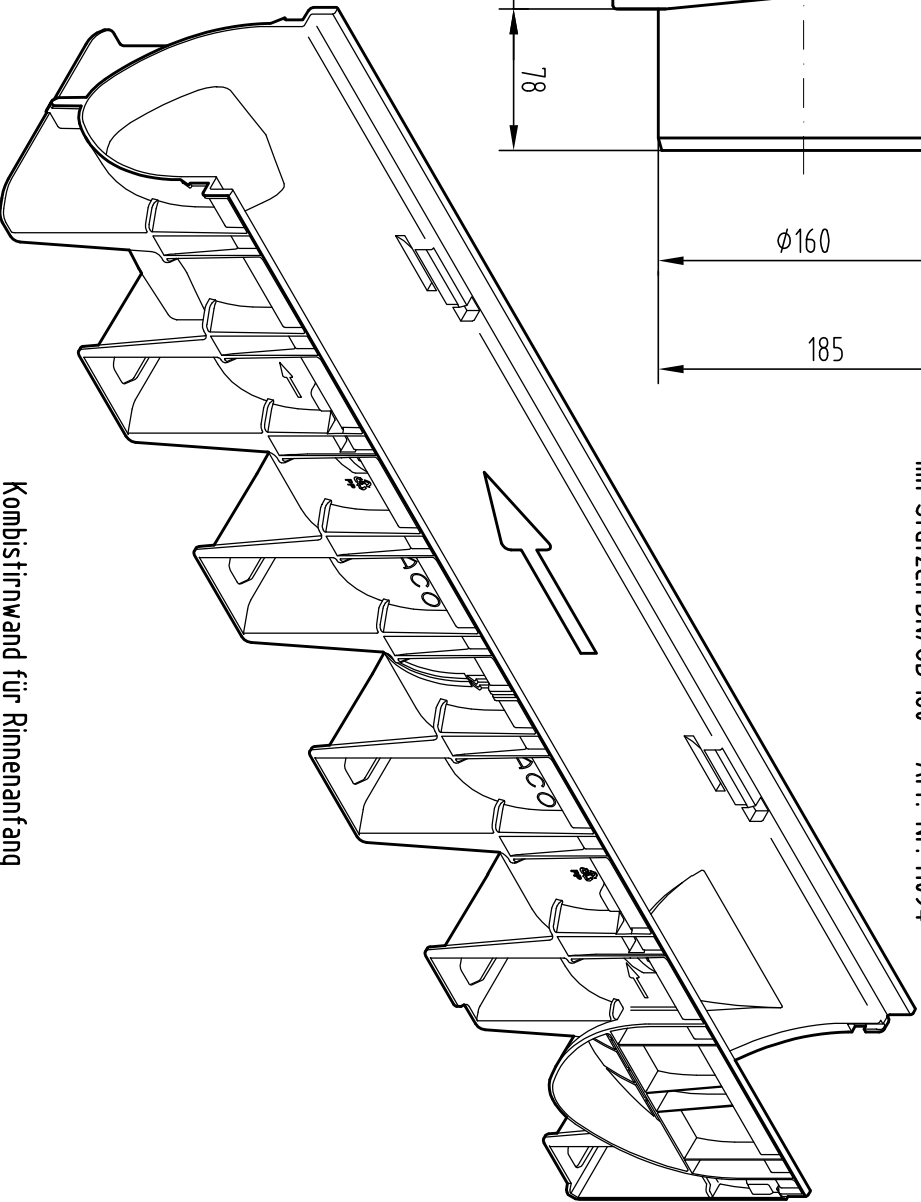
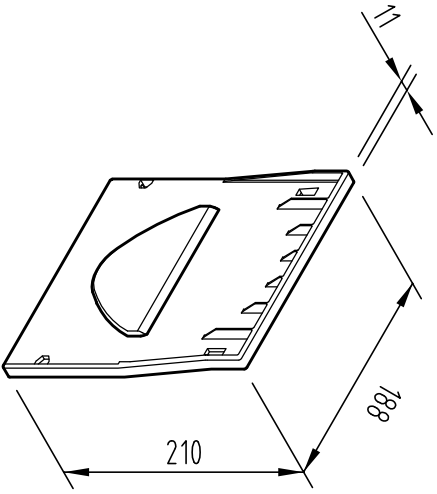
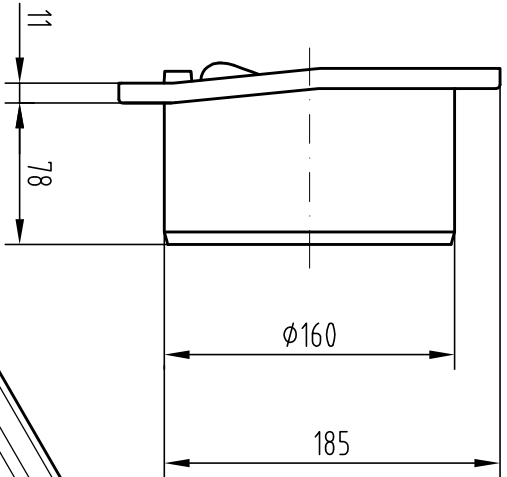
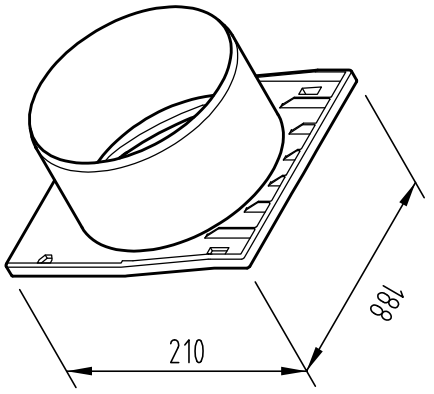

Stirrwand für Rinnenende  
mit Stützen DN/OD 160 Art.-Nr. 11094

Kombistirrwand für Rinnenanfang  
und -ende Art.-Nr. 11093

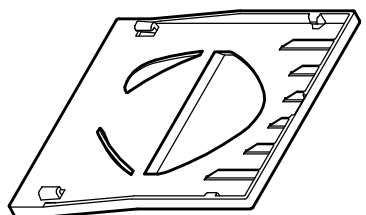

**Benennung:**  
ACO XtraDrain Kombistirrwand / Stirrwand mit  
Stützen DN/OD 160, für Kunststoffrinne NW 150  
Art.-Nr. 11093, 11094

Technische Änderungen vorbehalten

	Datum	Name
Gez.	28.05.2010	bschmidtke
Upd.	30.06.2011	debeling
Norm		

Schutzvermerk gemäß DIN 34



**ACO Tiefbau**

ACO Tiefbau Vertrieb GmbH  
24555 Rendsburg, Postfach 309  
Tel. 04331 / 354-500  
Fax 04331 / 354-358  
www.aco-tiefbau.de

Zeichnung-Nr.  
**G1-M01-1223-3**

Ers. für:

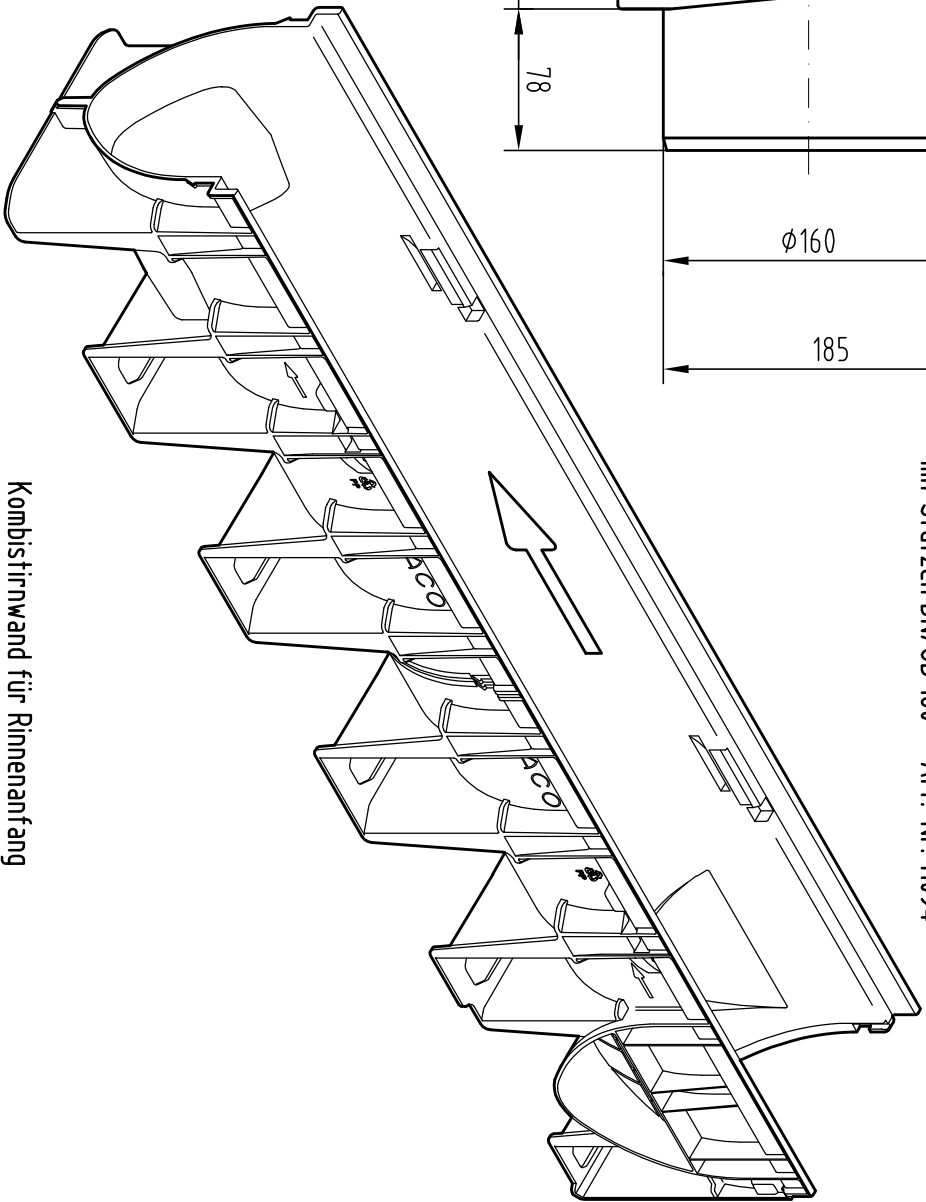
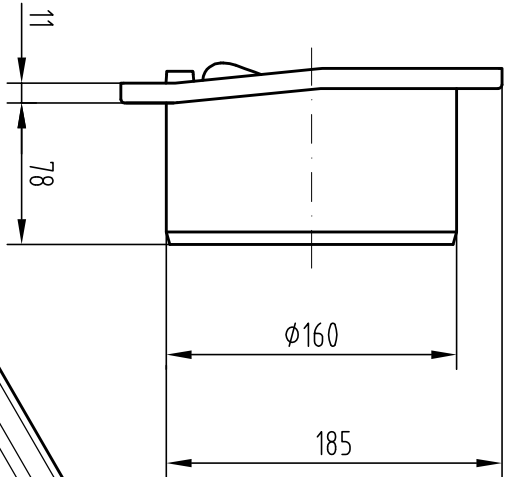
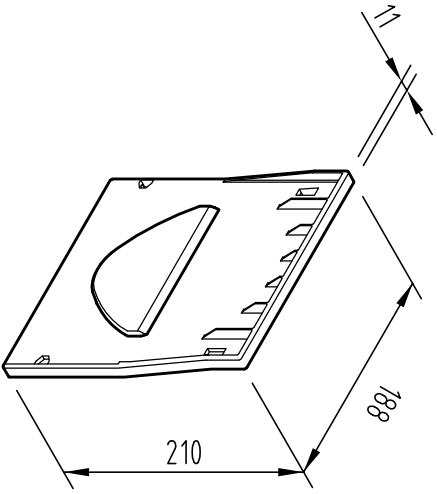
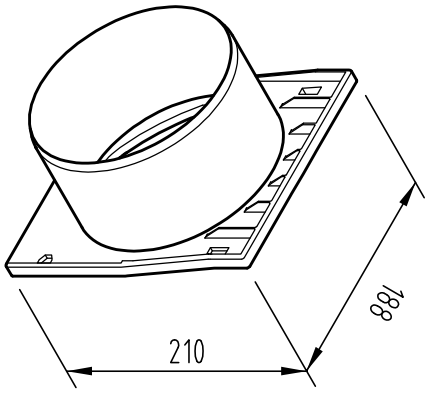

Stirrwand für Rinnenende  
mit Stützen DN/OD 160 Art.-Nr. 11094

Kombistirrwand für Rinnenanfang  
und -ende Art.-Nr. 11093

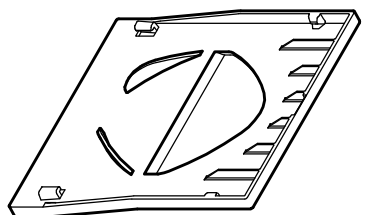

**Benennung:**  
ACO XtraDrain Kombistirrwand / Stirrwand mit  
Stützen DN/OD 160, für Kunststoffrinne NW 150  
Art.-Nr. 11093, 11094

Technische Änderungen vorbehalten

	Datum	Name
Gez.	28.05.2010	bschmidtke
Upd.	30.06.2011	debeling
Norm		



**ACO Tiefbau**

ACO Tiefbau Vertrieb GmbH  
24555 Rendsburg, Postfach 309  
Tel. 04331 / 354-500  
Fax 04331 / 354-358  
www.aco-tiefbau.de

Zeichnung-Nr.  
**G1-M01-1223-3**

Ers. für:

Schutzvermerk gemäß DIN 34

# Caniveau sans pente intégrée, longueur 1000 mm

## Informations produit pour le groupe de produits

- Système de caniveau selon EN 1433/DIN 19580
- Classe de résistance A15 – C 250
- En option, dans des tailles nominales de 100, 150 ou 200 mm
- Avec ouverture latérale préfabriquée pour les joints d'angle, en T et transversaux

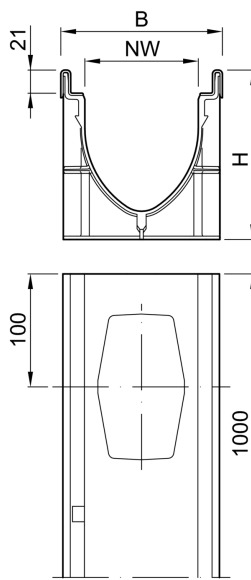

## Données techniques de l'article 11111

Largeur	Hauteur	Longueur	Poids
[mm]	[mm]	[mm]	[kg]
192	210	1000	4,0

## Accessoires

Description	Utilisé avec	Article numéro	Description
About universel	■ XtraDrain avec bord en plastique et bord en acier galvanisé	11093	■ Pour le début et la fin du canal
			■ Fabriqué en polypropylène
About	■ XtraDrain avec bord en plastique et bord en acier galvanisé	11094	■ Sans manchon
			■ Poids: 0,1 kg
Adaptateur de sortie	■ XtraDrain avec bord en plastique et bord en acier galvanisé	11288	■ Fabriqué en polypropylène
			■ Avec manchon
	Diamètre nominal 150, DN/OD 160		Poids: 0,2 kg
	Diamètre nominal 150, DN/OD 160		■ Pour le raccordement des tubulures vertical
			Poids: 0,3 kg

Description	Utilisé avec	Article numéro	Description
Crochet de levage pour grille	■ Grille de recouvrement	01290	■ Pour soulever les grilles de recouvrement ■ Acier galvanisé ■ Poids: 0,3 kg
Crochet de levage pour grille, petit	■ Grille métallique Q <sup>+</sup> ■ Grille composite ■ Grille à profils longitudinaux ■ Grille à barres longitudinales	01367	■ Pour soulever les grilles de recouvrement ■ Acier, peint en noir ■ Poids: 0,2 kg

Vous trouverez d'autres accessoires sous → 11111