

Art.-Nr. 11192

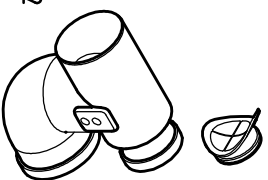

Art.-Nr. 11387

Zu Art.-Nr. 11387



Benennung:
ACO Xtradrain X 200 C Kunststoffrinne mit Ablaufschacht, Ablaufadapter DN/OD 200 und Eimer
Art.-Nr. 11018, 11387, 11192

Name	Datum	Gez.	Upd.	Norm
debeling	18.02.2009		30.06.2011	
debeling				

Zeichnung-Nr.
G1-M01-1226-3

ACO Tiefbau Vertrieb GmbH
24555 Rendsburg, Postfach 309
Tel. 04331 / 354-500
Fax 04331 / 354-358
www.aco-tiefbau.de

Technische Änderungen vorbehalten

Schutzvermerk gemäß DIN 34

Ers. für:

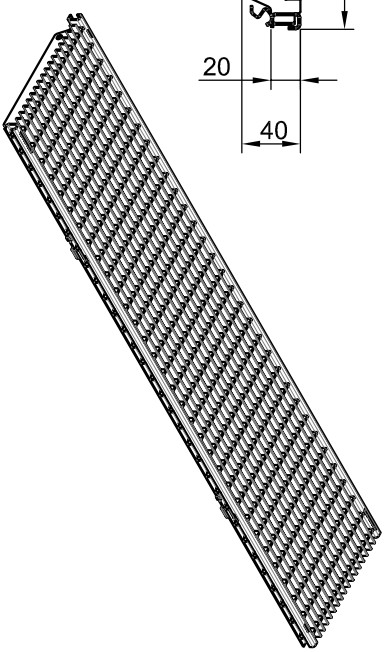
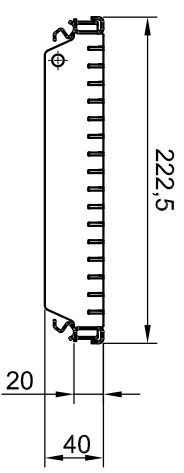
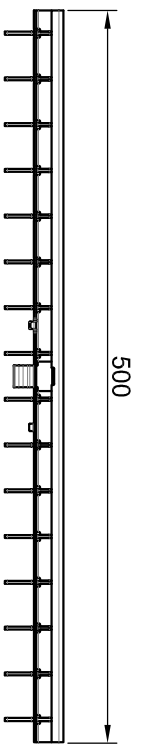
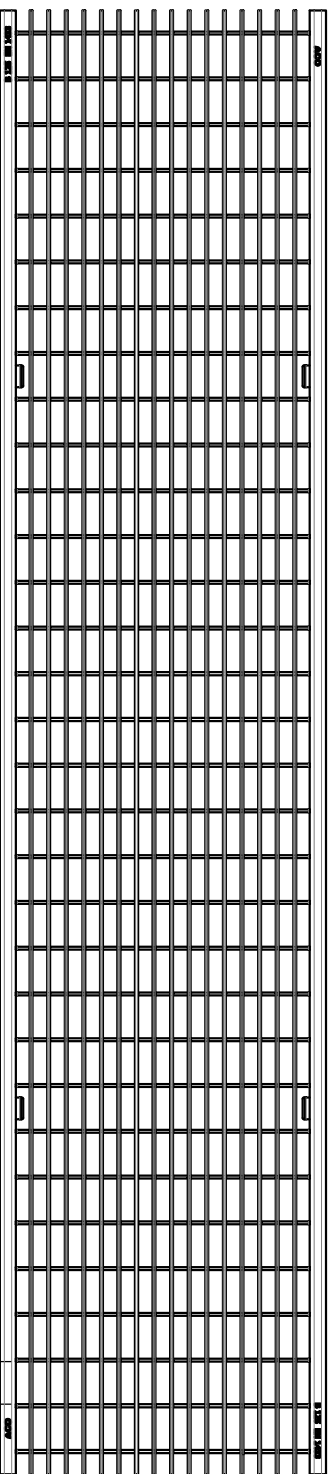
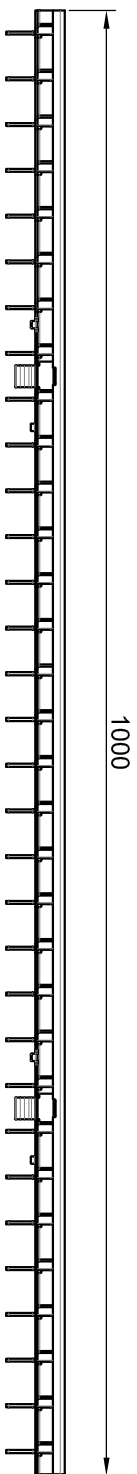

Inloopdoorsnede /
absorption: 1575 cm²/m

Naam - Nom Multiline V 200 Q+ maastrooster uit verzinkt staal kl. B 125 KN (mazen / mailles 30x10 mm) Q+ grille caillabois en acier galvanisé cl. B 125 KN		Name SB TS		Date 05/01/17 05/01/17			ACO Passavant NV/SA Peenikker 8 B - 1785 Merchtem Tel.: 052/38.17.70 Fax: 052/38.17.71 info@aco.be www.aco.be	
Technische veranderingen voorbehouden - Sous réserve de changements techniques		Maten in millimeter		Artikel-Nr. - N° d'article 133613 (1 m) 133614 (0,5 m)			Tekening Nr - Dessin n°	

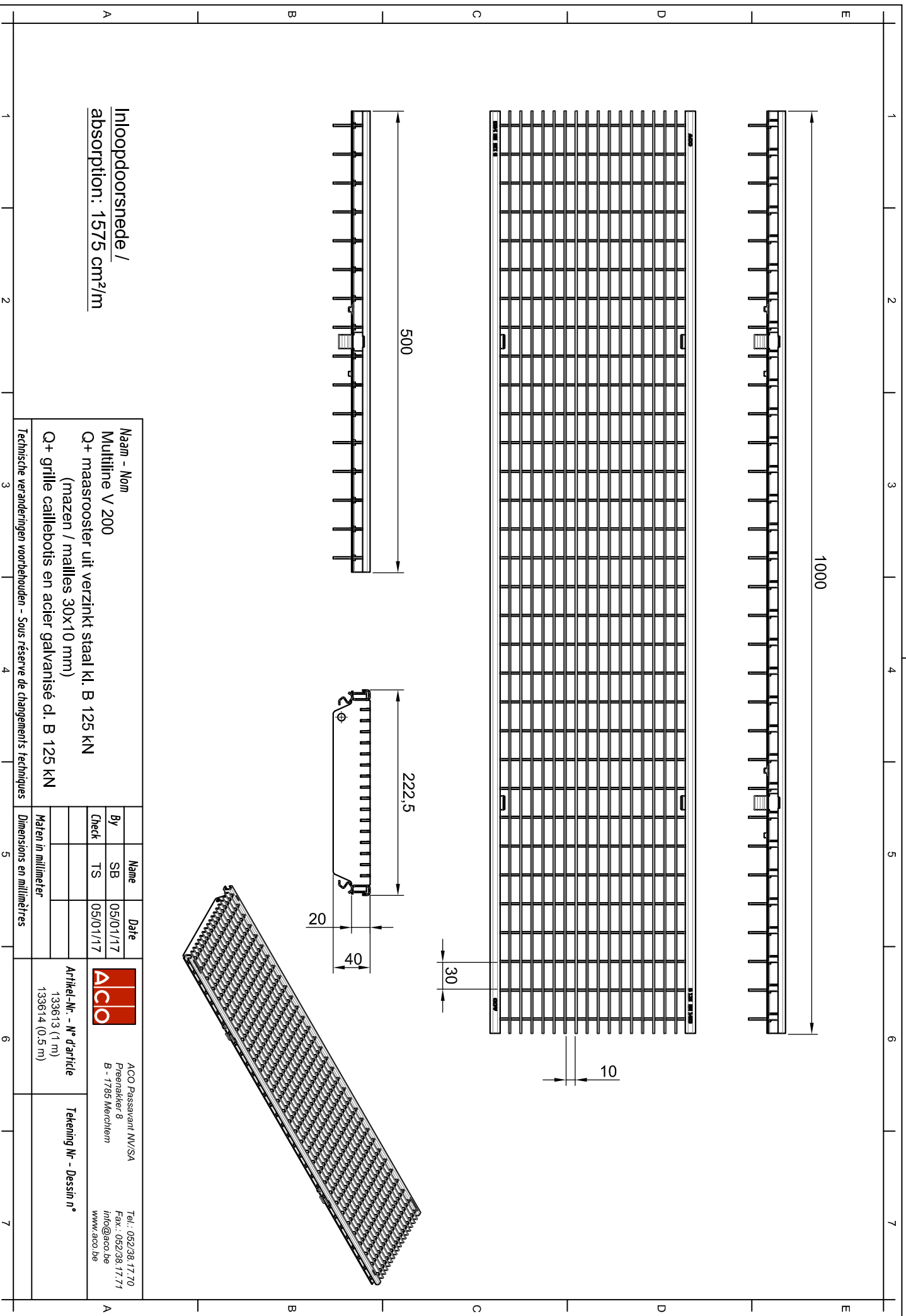

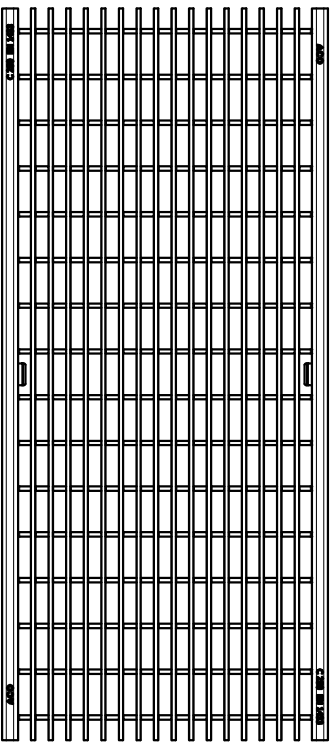
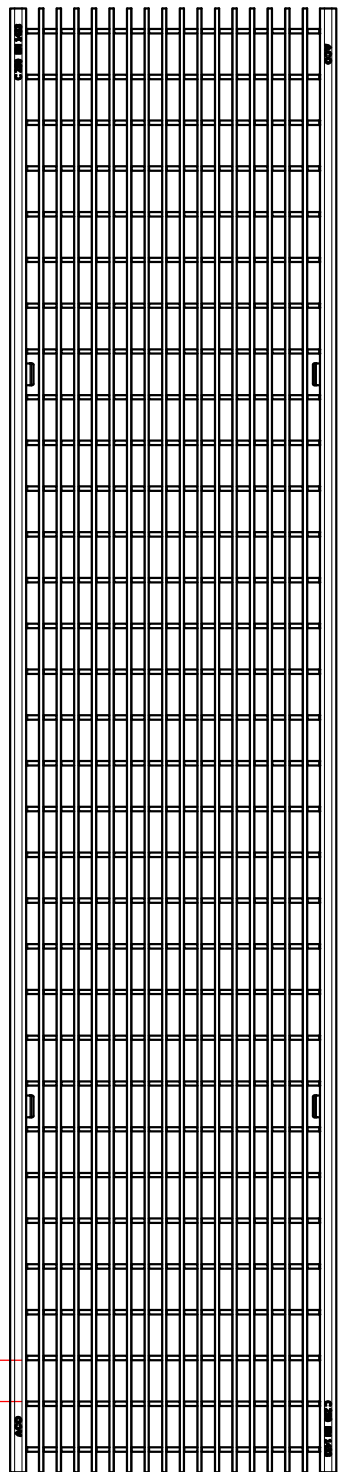
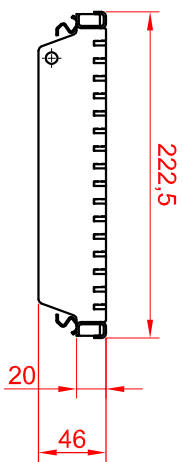
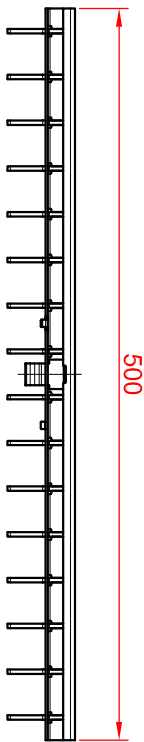
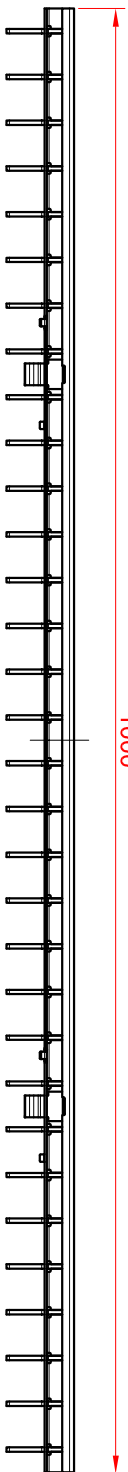

Inlooppdoorsnede /
absorption: 1377 cm²/m

Naam - Nom
Multiline V 200
Q+ maastrooster uit verzinkt staal kl. C 250 KN
(mazen / mailles 30x10 mm)
Q+ grille caillabois en acier galvanisé cl. C 250 KN

Technische veranderingen voorbehouden - Sous réserve de changements techniques		Dimensions en millimètres	
By	Name	Date	
SB	SB	20/09/17	
Check	TS	20/09/17	
Maten in millimeter			



Artikel-Nr. - N° d'article
133617 (1 m)
133618 (0,5 m)

ACO Passavant NV/SA
Peebikker 8
B - 1785 Merchtem
Tel.: 052/38.17.70
Fax: 052/38.17.71
info@aco.be
www.aco.be

Tekening Nr - Dessin n°

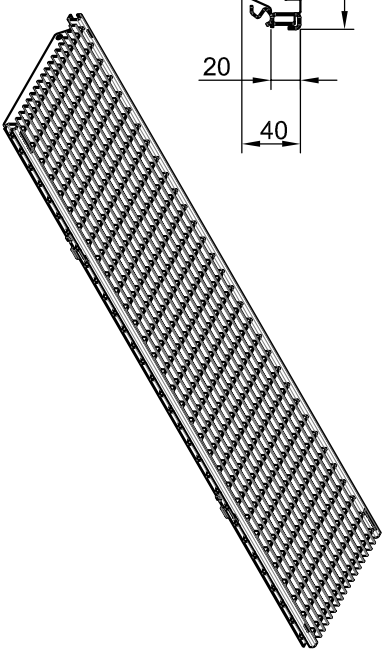
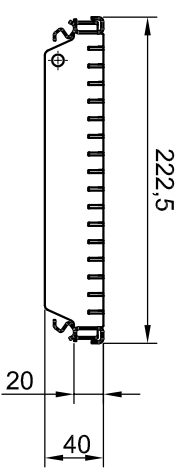
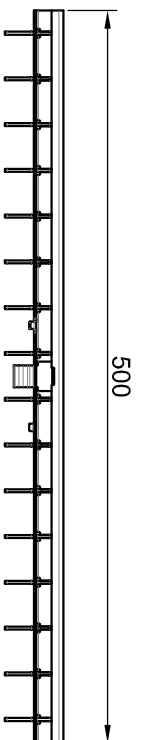
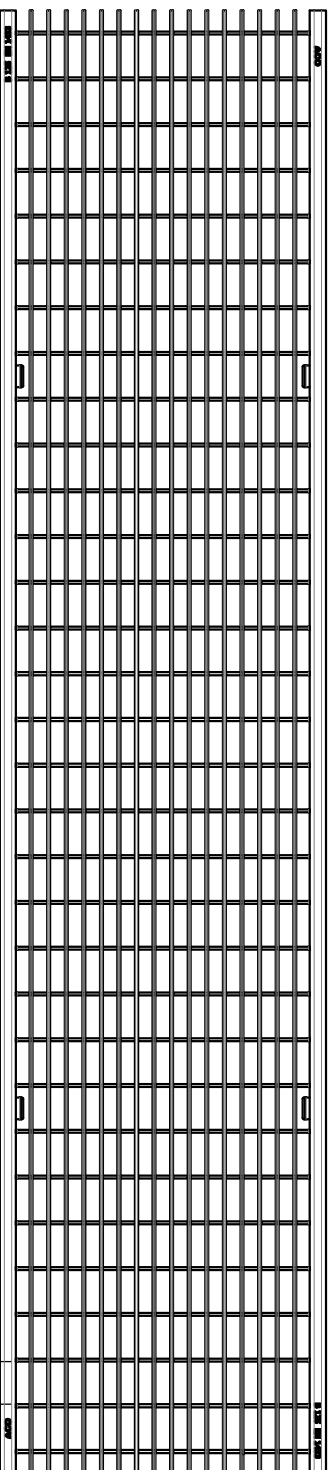
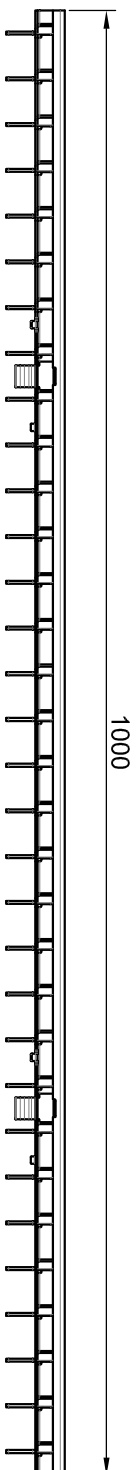

Inloopdoorsnede /
absorption: 1575 cm²/m

Naam - Nom Multiline V 200 Q+ maastrooster uit roestvrij staal kl. B 125 kN (AISI 304, mazen / mailles 30x10 mm) Q+ grille caillaboits en acier inoxydable cl. B 125 kN		Name SB TS	Date 05/01/17 05/01/17		ACO Passavant NV/SA Peenakker 8 B - 1785 Merchtem Tel.: 052/38.17.70 Fax: 052/38.17.71 info@aco.be www.aco.be
Technische veranderingen voorbehouden - Sous réserve de changements techniques		Maten in millimeter			
Dimensions en millimètres		Maten in millimeter			

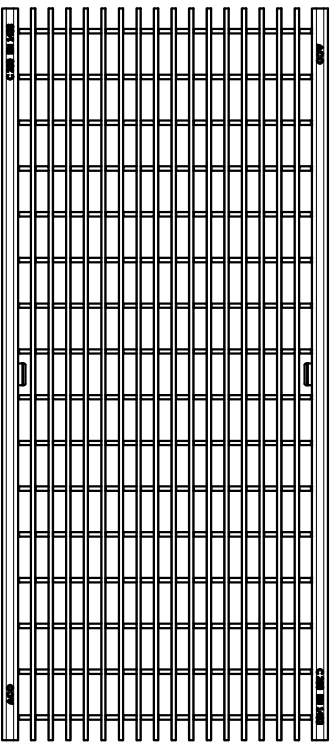
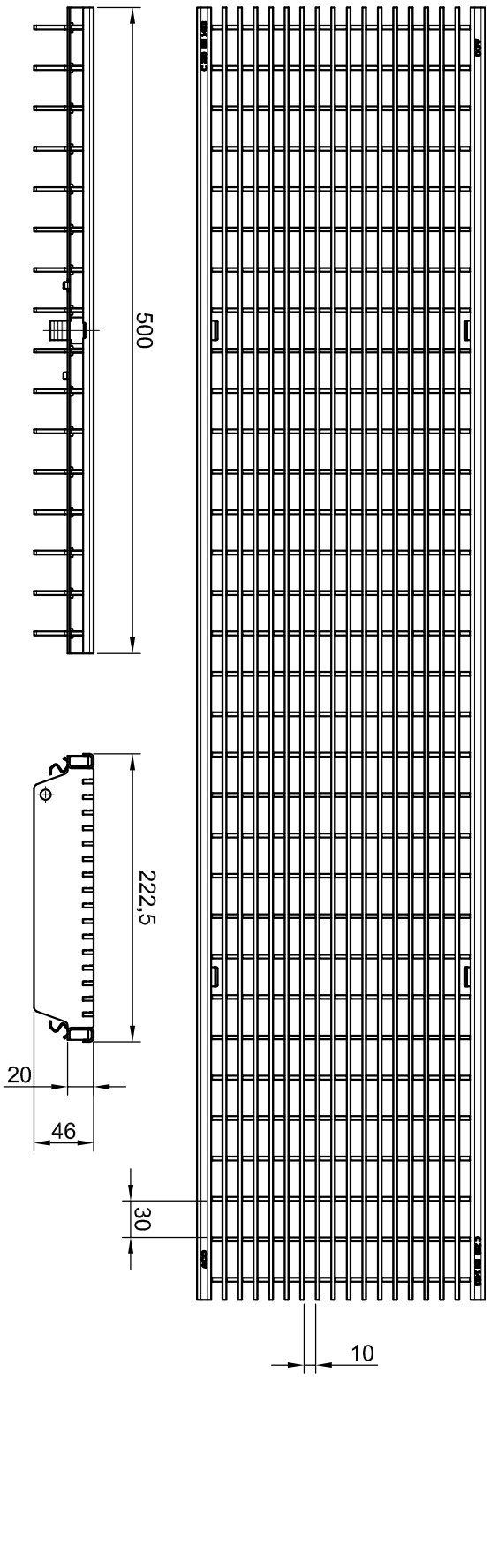
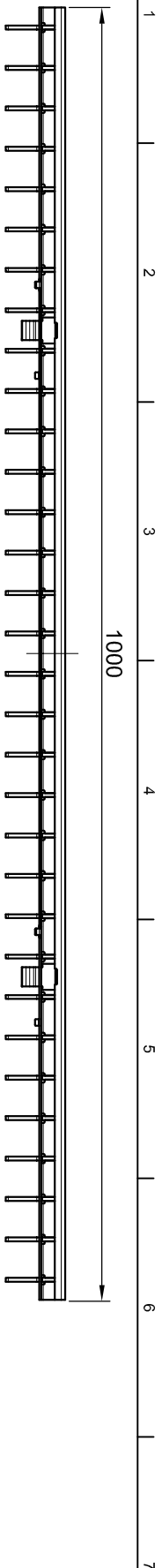

Inloopdoorsnede /
absorption: 1377 cm²/m

Naam - Nom
Multiline V 200
Q+ maastrooster uit roestvrij staal kl. C 250 kN
(AISI 304, mazen / mailles 30x10 mm)
Q+ grille caillaboits en acier inoxydable cl. C 250 kN

Technische veranderingen voorbehouden - Sous réserve de changements techniques		Dimensions en millimètres	
By	Name	Date	
SB	SB	20/09/17	
Check	TS	20/09/17	
Maten in millimeter			



Artikel-Nr. - N° d'article
133619 (1 m)
133620 (0,5 m)

ACO Passavant NV/SA
Peebnikker 8
B - 1785 Merchtem
Tel.: 052/38.17.70
Fax.: 052/38.17.71
info@aco.be
www.aco.be

Tekening Nr - Dessin n°

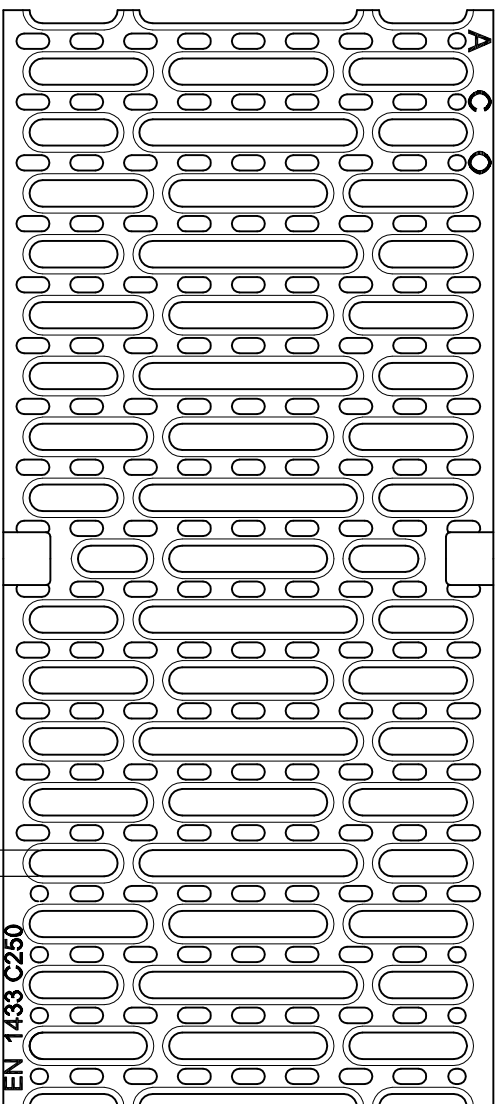
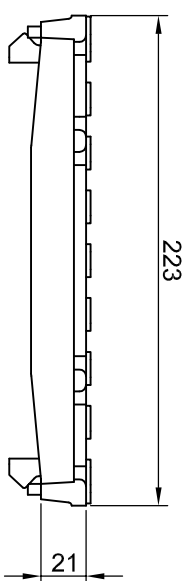
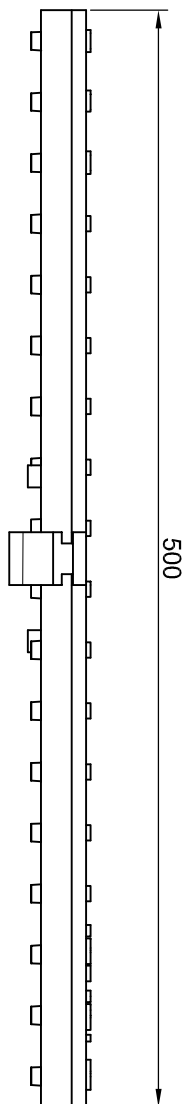

Inloopdoorsnede /
absorption: 740 cm²/m

Naam - Nom
Multiiline V 200
sleufrooster uit gietijzer kl. C 250 KN
grille passerelle en fonte cl. C 250 KN

Technische veranderingen voorbehouden - Sous réserve de changements techniques

Maten in millimeter	
By	SB
Check	SW

Dimensions en millimètres



ACO Passavant NV/SA
Peebakkert 8
B - 1785 Merchtem

Tel.: 052/38.17.70
Fax: 052/38.17.71
info@aco.be
www.aco.be

Artikel-Nr. - N° d'article
13470

Tekening Nr - Dessin n°

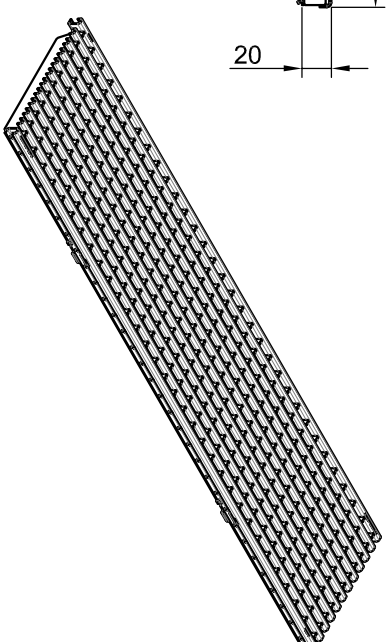
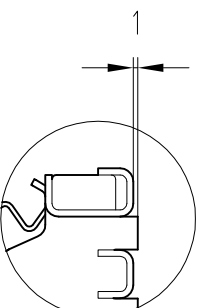
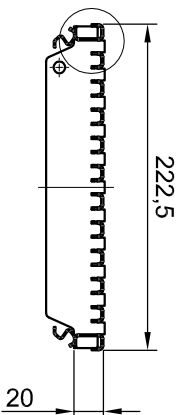
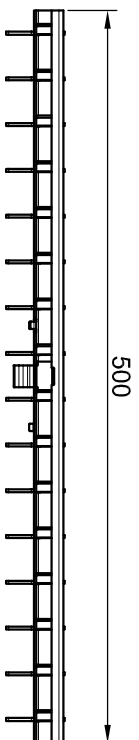
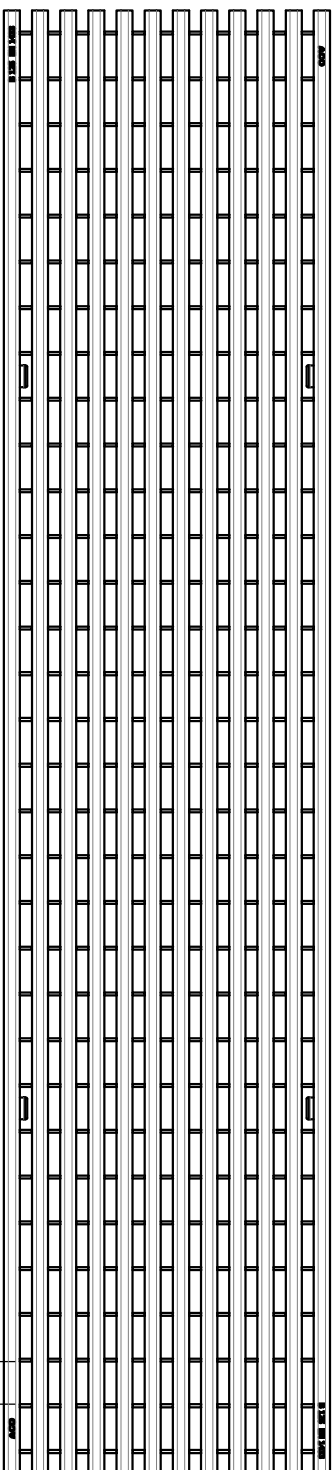
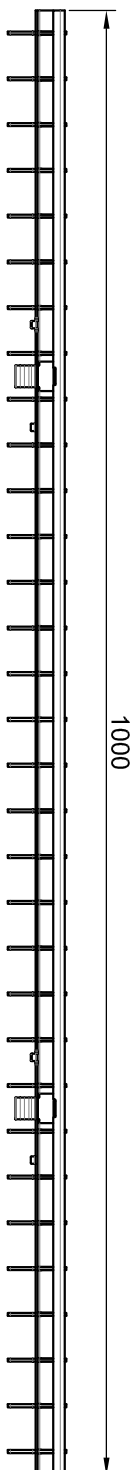

Inloopdoorsnede /
absorption: 846 cm²/m

Naam - Nom
Multiline V 200
lengtestaafrooster uit verzinkt staal
B 125 kN - profiel U profiel 8 mm
grille passerelles longitudinales en acier galvanisé

Technische veranderingen voorbehouden - Sous réserve de changements techniques

Maten in millimeter	
By	Name
SB	SB
Check	TS
	05/01/17



Artikel-Nr. - N° d'article
133629 (1 m)
133630 (0,5 m)

ACO Passavant NV/SA
Peebikker 8
B - 1785 Merchtem
Tel.: 052/38.17.70
Fax.: 052/38.17.71
info@aco.be
www.aco.be

Tekening Nr - Dessin n°

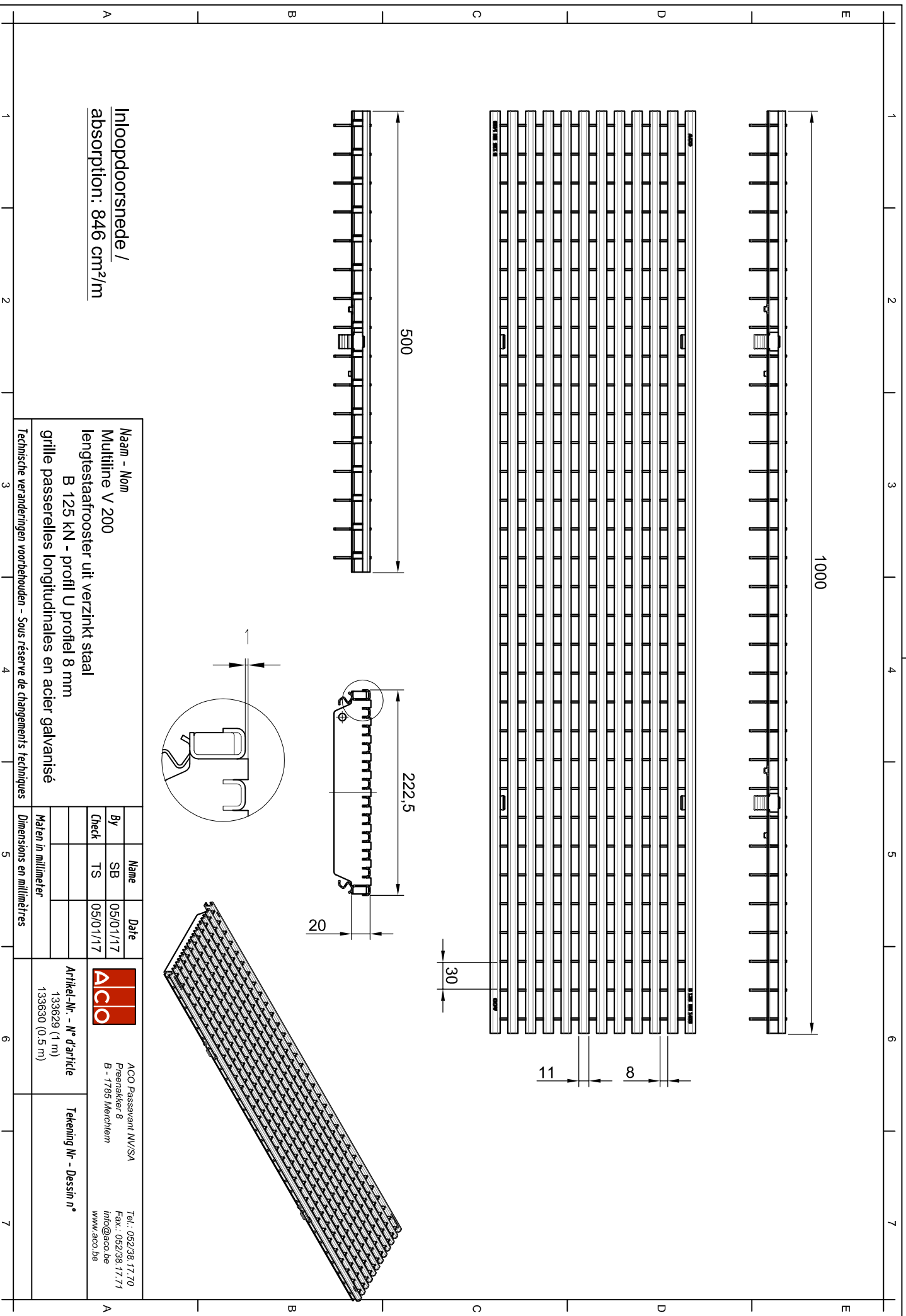

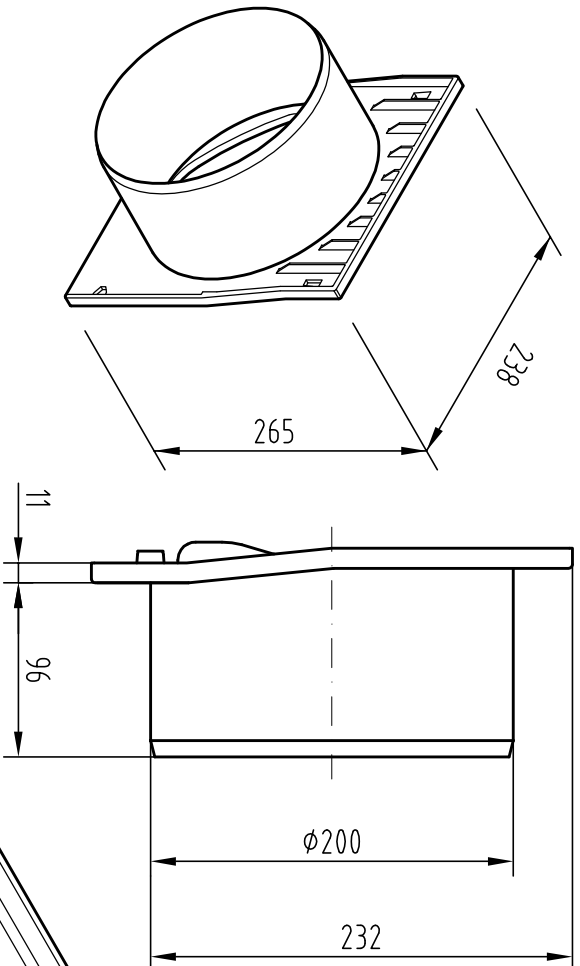

Stirnwand für Rinnenende
mit Stützen DN/OD 200 Art.-Nr. 11099

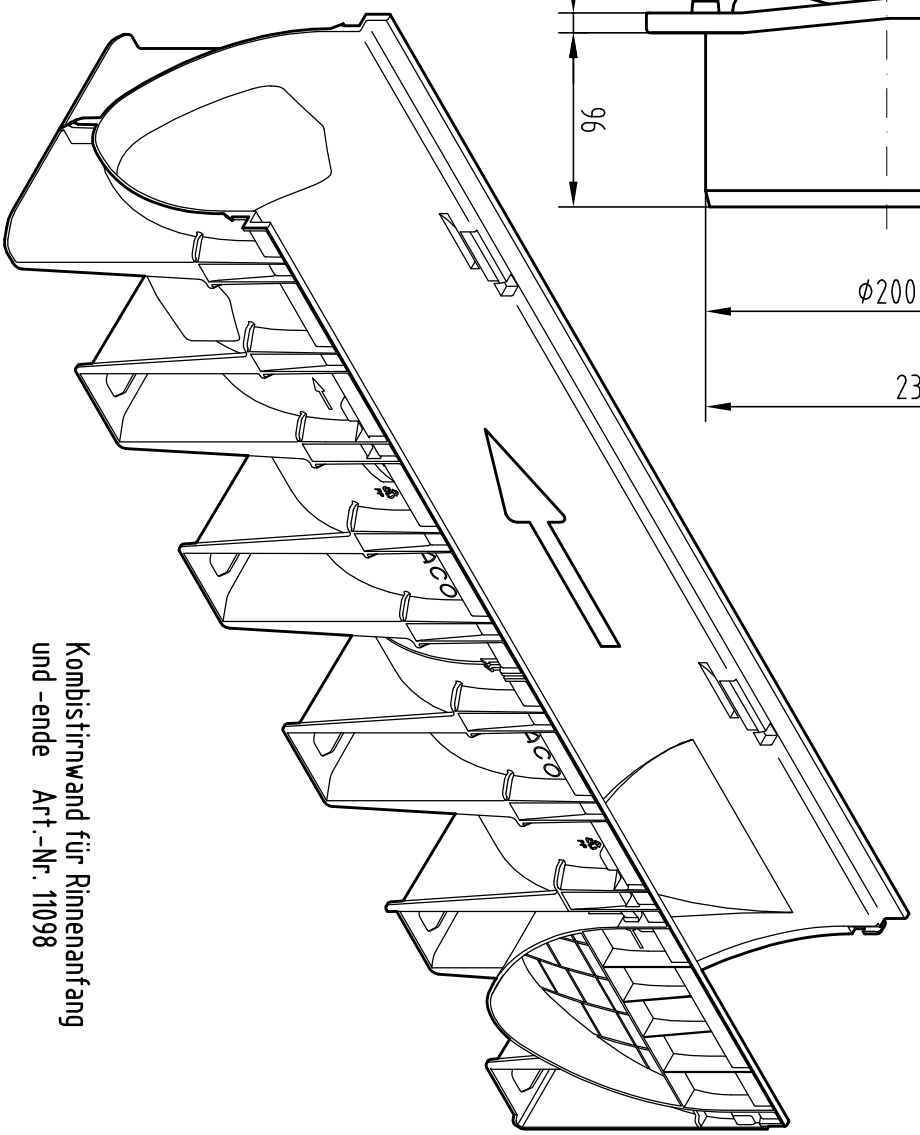

Kombistirnwand für Rinnenanfang
und -ende Art.-Nr. 11098

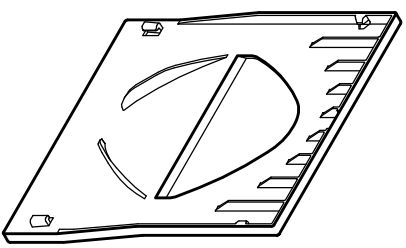
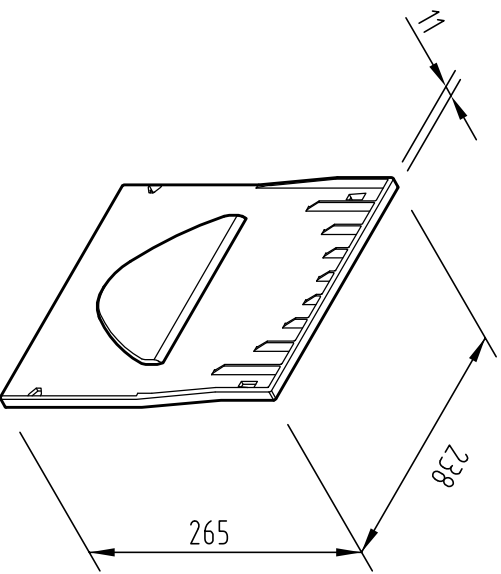

Benennung:
ACO XtraDrain X 200 Kombistirnwand / Stirnwand
mit Stützen DN/OD 200, für Kunststoffrinne NW 200
Art.-Nr. 11098, 11099

	Datum	Name
Gez.	28.05.2010	bschmidtke
Upd	30.06.2011	debeling
Norm		

ACO Tiefbau Vertrieb GmbH
24555 Rendsburg, Postfach 309
Tel. 04331 / 354-500
Fax 04331 / 354-358
www.aco-tiefbau.de

Zeichnung-Nr.
G1-M01-1224-3

Ers. für:
Schutzvermerk gemäß DIN 34

Technische Änderungen vorbehalten

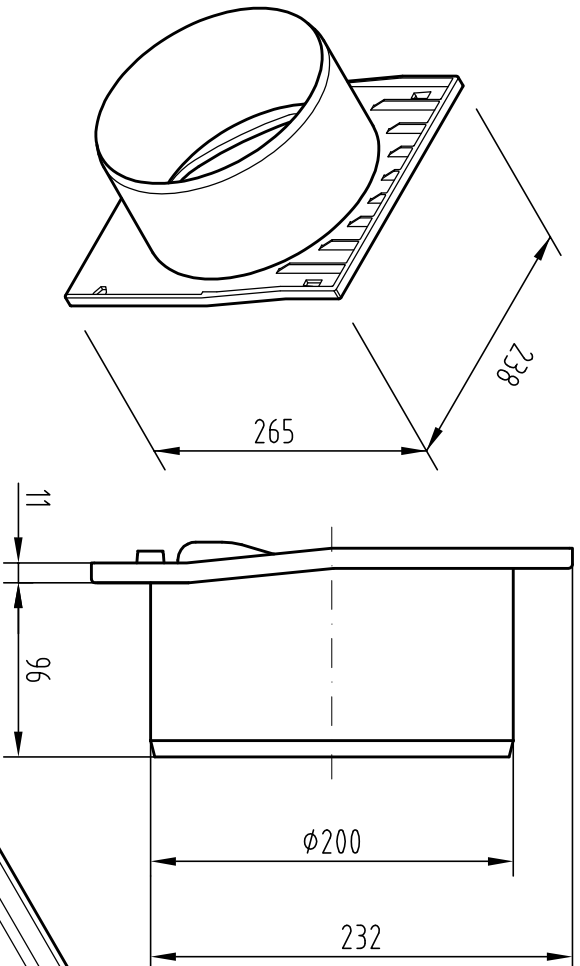

Stirnwand für Rinnenende
mit Stützen DN/OD 200 Art.-Nr. 11099

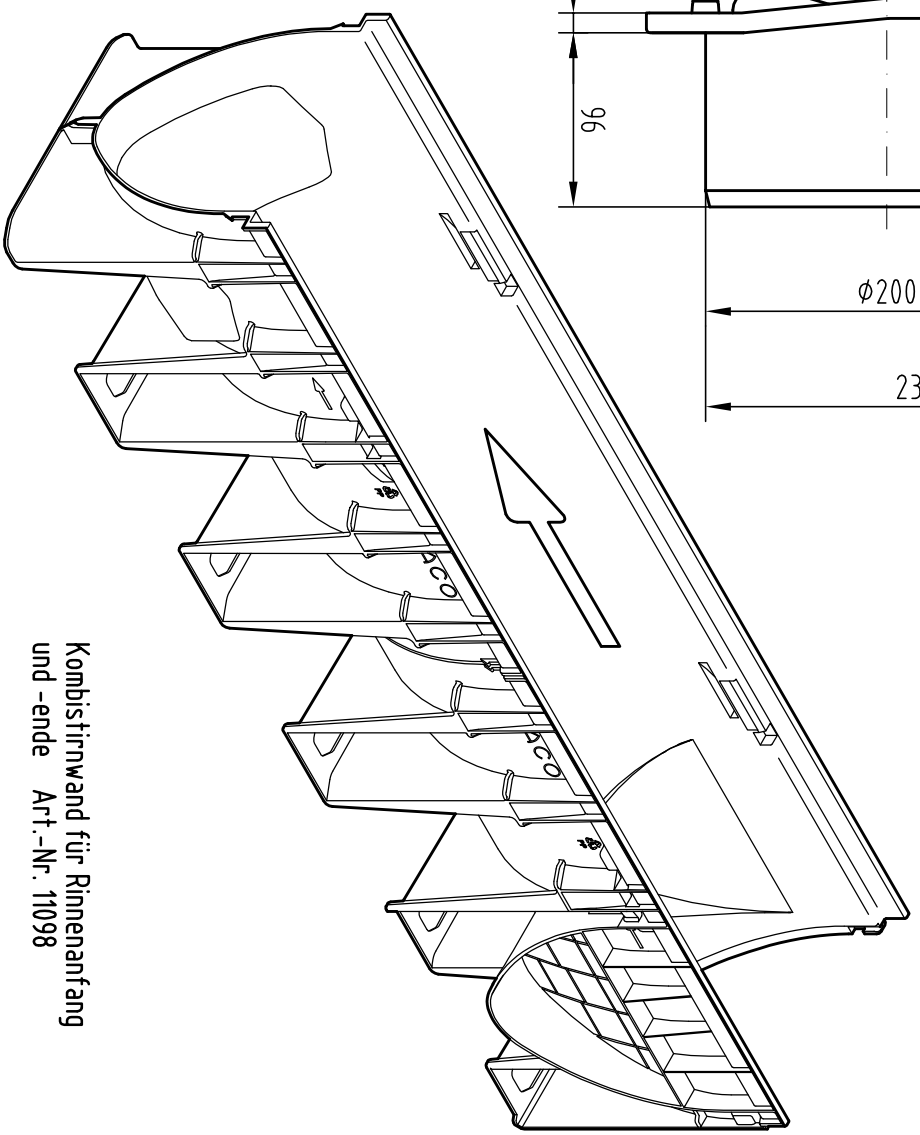

Kombistirnwand für Rinnenanfang
und -ende Art.-Nr. 11098

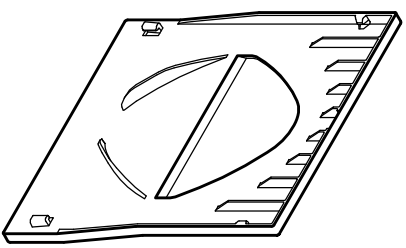
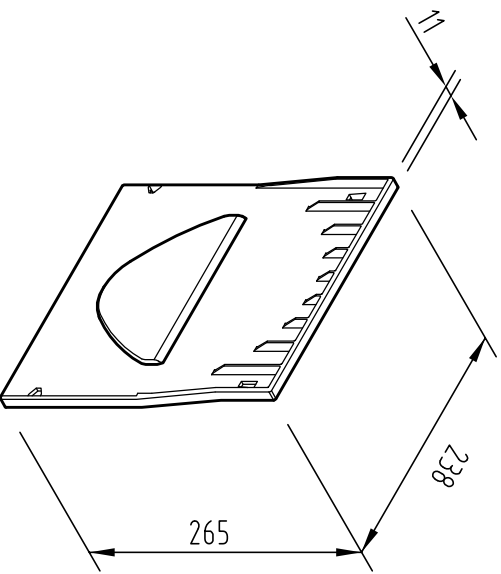

Benennung:
ACO XtraDrain X 200 Kombistirnwand / Stirnwand
mit Stützen DN/OD 200, für Kunststoffrinne NW 200
Art.-Nr. 11098, 11099

	Datum	Name
Gez.	28.05.2010	bschmidtke
Upd	30.06.2011	debeling
Norm		

ACO Tiefbau Vertrieb GmbH
24555 Rendsburg, Postfach 309
Tel. 04331 / 354-500
Fax 04331 / 354-358
www.aco-tiefbau.de

Zeichnung-Nr.
G1-M01-1224-3

Ers. für:
Schutzvermerk gemäß DIN 34

Technische Änderungen vorbehalten

Caniveau sans pente intégrée, longueur 1000 mm

Informations produit pour le groupe de produits

- Système de caniveau selon EN 1433/DIN 19580
- Classe de résistance A15 – C 250
- En option, dans des tailles nominales de 100, 150 ou 200 mm
- Avec ouverture latérale préfabriquée pour les joints d'angle, en T et transversaux

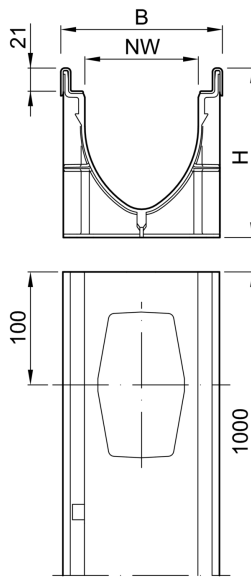

Données techniques de l'article 11118

Largeur	Hauteur	Longueur	Poids
[mm]	[mm]	[mm]	[kg]
242	265	1000	4,9

Accessoires

Description	Utilisé avec	Article numéro	Description
About universel	■ XtraDrain avec bord en plastique et bord en acier galvanisé	11098	■ Pour le début et la fin du canal
			■ Fabriqué en polypropylène
About	■ XtraDrain avec bord en plastique et bord en acier galvanisé	11099	■ Sans manchon
			■ Poids: 0,1 kg
			■ Fabriqué en polypropylène
Adaptateur de sortie	■ XtraDrain avec bord en plastique et bord en acier galvanisé	11289	■ Avec manchon
			■ Diamètre nominal 200, DN/OD 200
			■ Poids: 0,2 kg
Adaptateur de sortie	■ XtraDrain avec bord en plastique et bord en acier galvanisé	11289	■ Fabriqué en polypropylène
			■ Pour le raccordement des tubulures vertical
	■ Diamètre nominal 200, DN/OD 200		■ Poids: 0,4 kg

Description	Utilisé avec	Article numéro	Description
Crochet de levage pour grille	■ Grille de recouvrement	01290	■ Pour soulever les grilles de recouvrement ■ Acier galvanisé ■ Poids: 0,3 kg
Crochet de levage pour grille, petit	■ Grille métallique Q ⁺ ■ Grille composite ■ Grille à profils longitudinaux ■ Grille à barres longitudinales	01367	■ Pour soulever les grilles de recouvrement ■ Acier, peint en noir ■ Poids: 0,2 kg

Vous trouverez d'autres accessoires sous → 11118

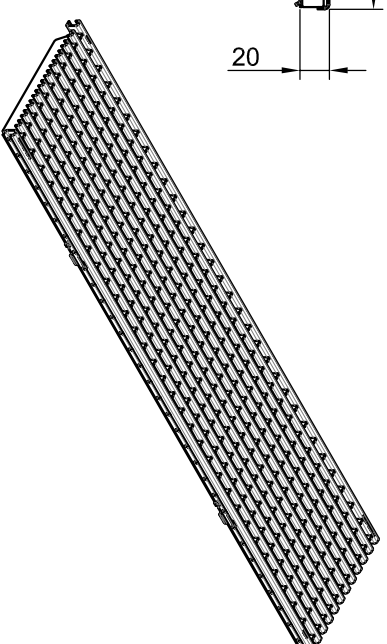
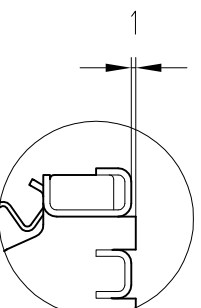
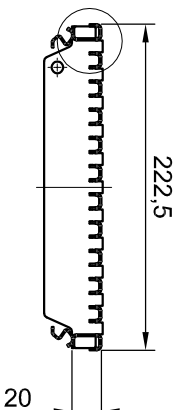
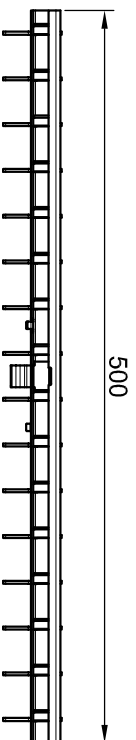
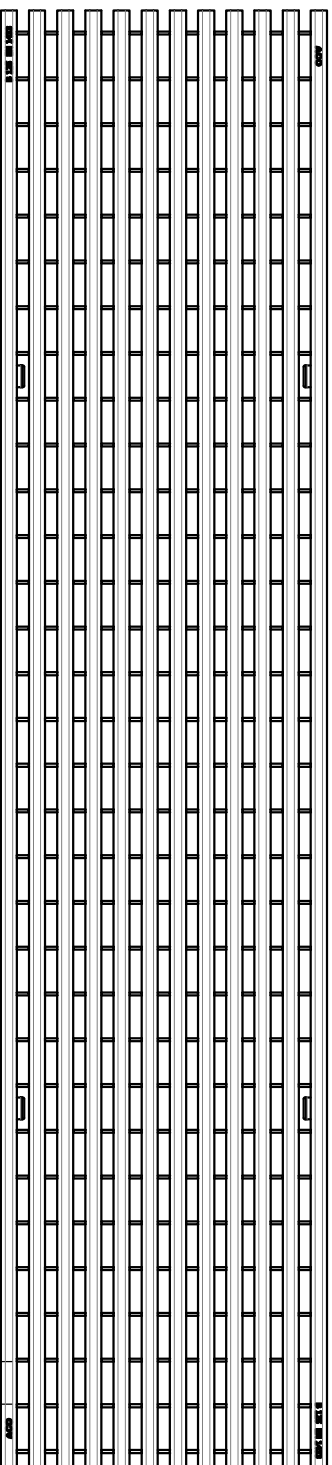
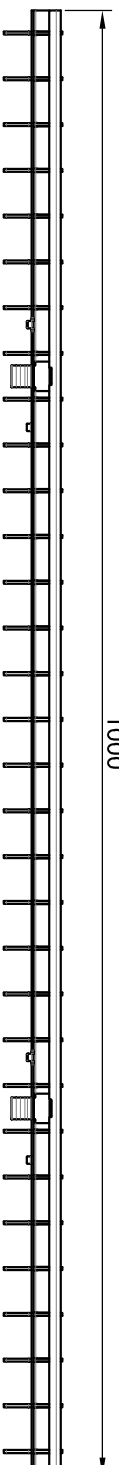

Inloopdoorsnede /
absorption: 846 cm²/m

Naam - Nom
Multiline V 200
lengtestaafrooster uit roestvrij staal
(AISI 304) - B 125 kN - profiel U profiel 8 mm
grille passerelles longitudinales en acier Inoxydable

Technische veranderingen voorbehouden - Sous réserve de changements techniques

Maten in millimeter		Dimensions en millimètres	
By	Name	Date	
SB	SB	05/01/17	
Check	TS	05/01/17	



ACO Passavant NV/SA
Peebikker 8
B - 1785 Merchtem

Tel.: 052/38.17.70
Fax: 052/38.17.71
info@aco.be
www.aco.be

Artikel-Nr. - N° d'article
133631 (1 m)
133632 (0,5 m)

Tekening Nr - Dessin n°