

Uitloop DN 150 / 200 met geïntegreerde lippendichting
 Sortie DN 150 / 200 avec joint à lèvres intégré

voor kanaal / pour caniveau type	h (mm)	Verzinkt staal / Acier galvanisé	Roestvrij staal / Acier inoxydable
0.	240	133591	133791
5.	265	133592	133792
10.	290	133593	133793
20.	340	133594	133794

Randbescherming uit / Feuilure en

Multiline V 200 S "Seal in" (0. - 20.)
 zandvang
 met geïntegreerde EPDM-afdichting thv tand/groef
 désableur
 avec joint EPDM incorporé à la connexion mâle/fem.
 belastingsklasse A15 - E600 classe de résistance

ACO
 ACO Passavant NV/SA Tel.: 052/38.17.70
 Preenakker 8 Fax.: 052/38.17.71
 B - 1785 Merchtem info@aco.be
 www.aco.be

Technische veranderingen voorbehouden - Sous réserve de changements techniques

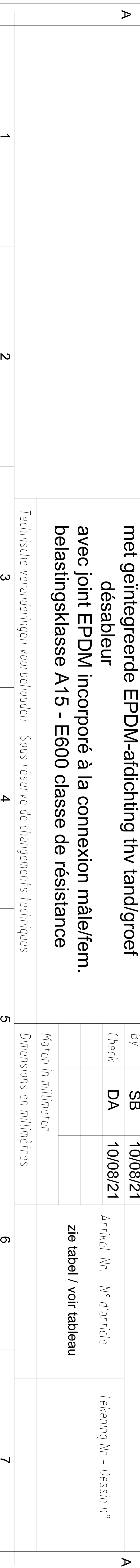

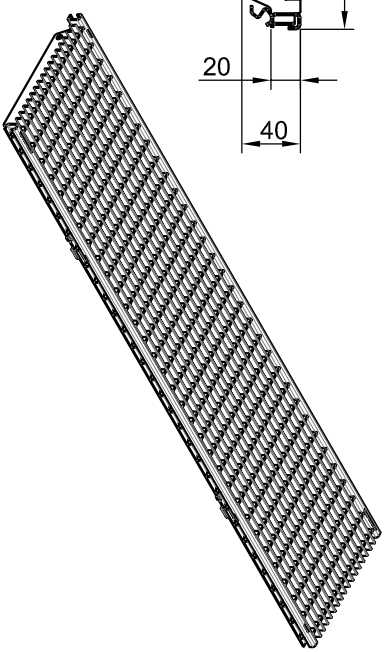
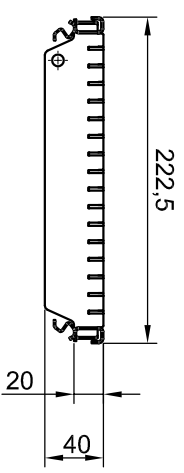
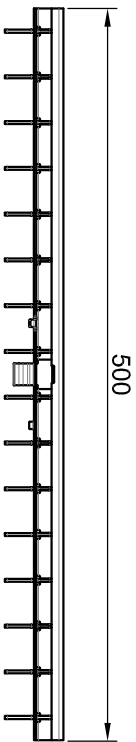
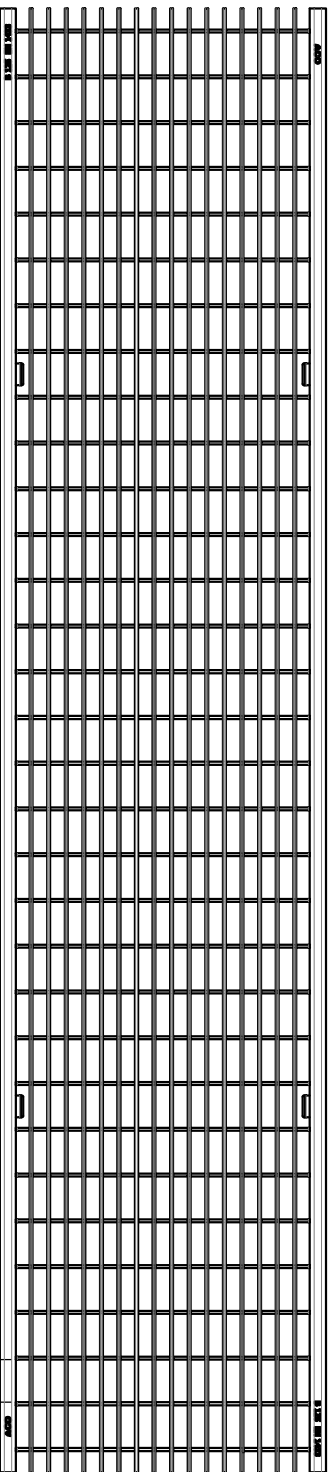
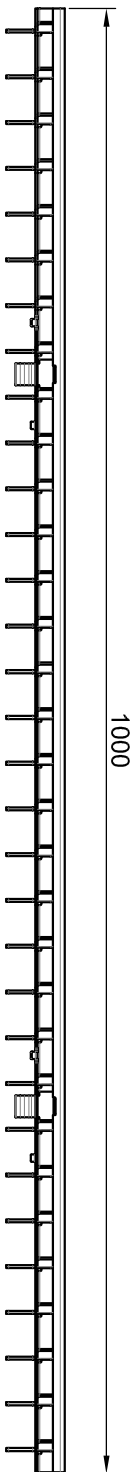

Inlooppdoorsnede /
absorption: 1575 cm²/m

Naam - Nom Multiline V 200 Q+ maastrooster uit verzinkt staal kl. B 125 KN (mazen / mailles 30x10 mm) Q+ grille caillaboits en acier galvanisé cl. B 125 KN		Name SB TS		Date 05/01/17 05/01/17			ACO Passavant NV/SA Peenikker 8 B - 1785 Merchtem Tel.: 052/38.17.70 Fax: 052/38.17.71 info@aco.be www.aco.be
Technische veranderingen voorbehouden - Sous réserve de changements techniques		Maten in millimeter		Artikel-Nr. - N° d'article 133613 (1 m) 133614 (0,5 m)			

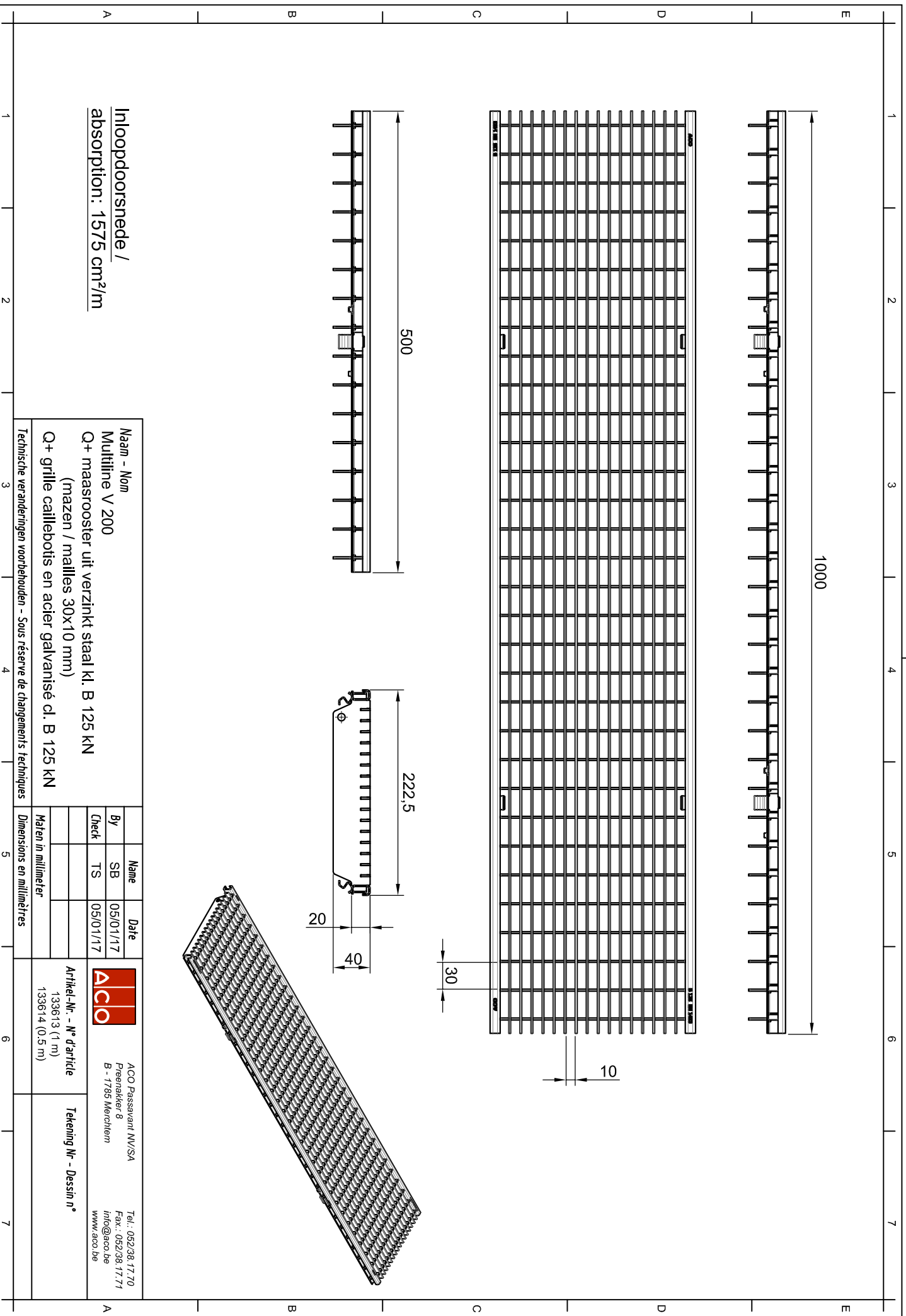

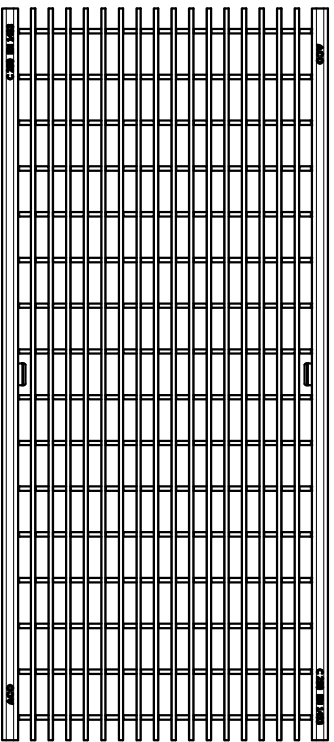
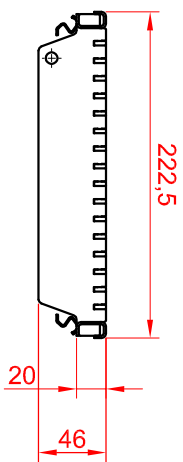
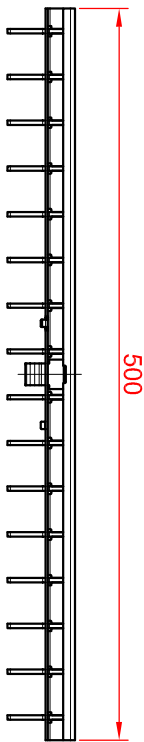
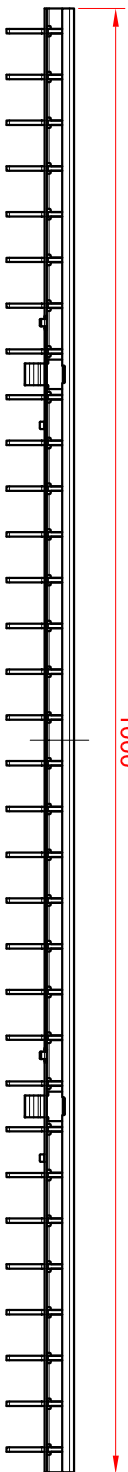

Inlooppdoorsnede /
absorption: 1377 cm²/m

Naam - Nom
Multiline V 200
Q+ maastrooster uit verzinkt staal kl. C 250 KN
(mazen / mailles 30x10 mm)
Q+ grille caillabois en acier galvanisé cl. C 250 KN

Technische veranderingen voorbehouden - Sous réserve de changements techniques		Dimensions en millimètres	
By	Name	Date	
SB	SB	20/09/17	
Check	TS	20/09/17	
Maten in millimeter			



Artikel-Nr. - N° d'article
133617 (1 m)
133618 (0,5 m)

ACO Passavant NV/SA
Peebikker 8
B - 1785 Merchtem

Tel.: 052/38.17.70
Fax: 052/38.17.71
info@aco.be
www.aco.be

Tekening Nr - Dessin n°

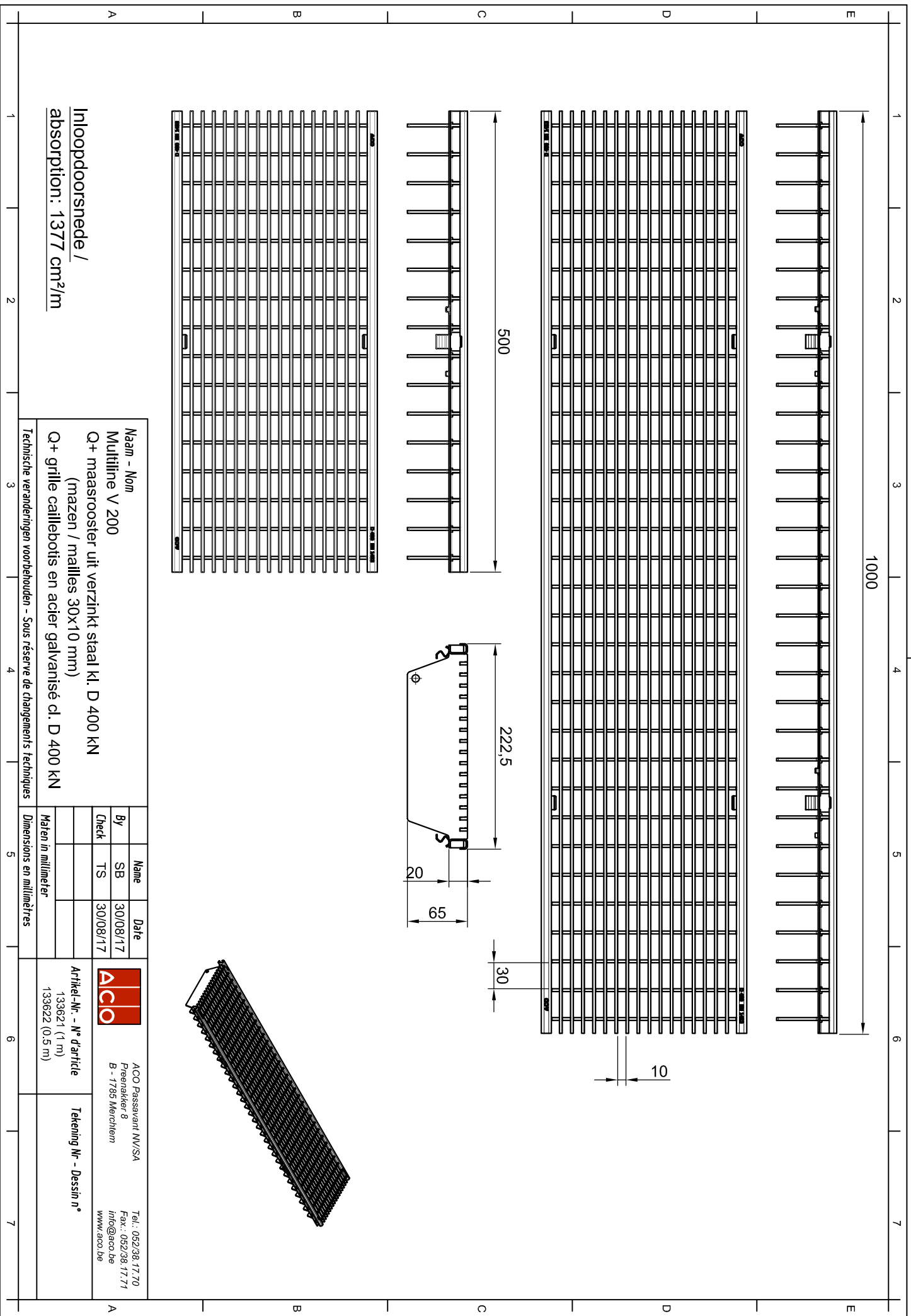

Inloopdoorsnede /
absorption: 1377 cm²/m

Naam - Nom Multiline V 200 Q+ maastrooster uit verzinkt staal kl. D 400 KN (mazet / mailles 30x10 mm) Q+ grille caillabois en acier galvanisé cl. D 400 KN		Technische veranderingen voorbehouden - Sous réserve de changements techniques	
Maten in millimeter		Dimensions en millimètres	
By	Name	Date	
Check	SB	30/08/17	
	TS	30/08/17	
Artikel-Nr. - N° d'article 133621 (1 m) 133622 (0,5 m)		Tekening Nr - Dessin n°	
		ACO Passavant NV/SA Peenikker 8 B - 1785 Merchtem Tel.: 052/38.17.70 Fax: 052/38.17.71 info@aco.be www.aco.be	

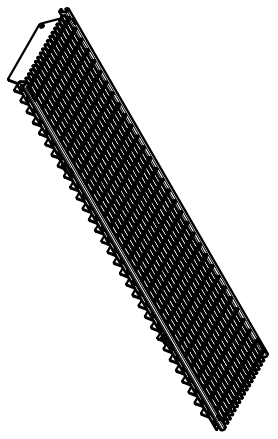

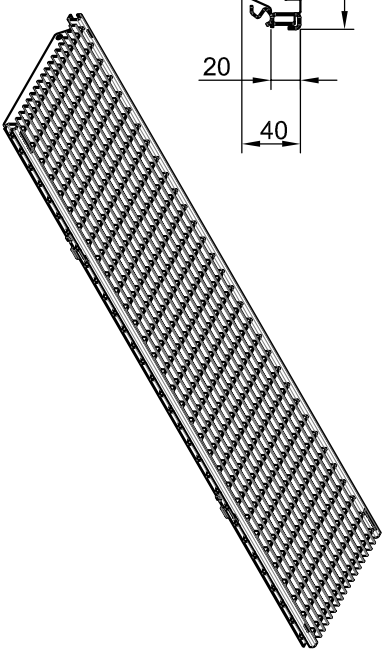
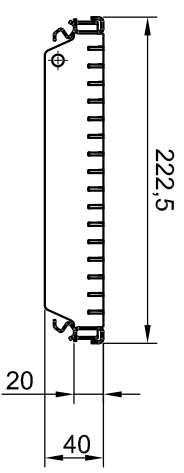
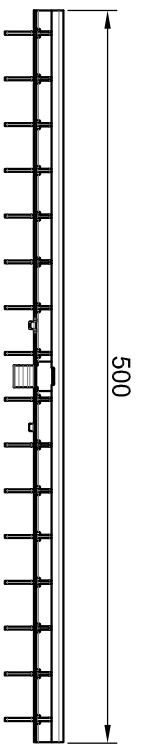
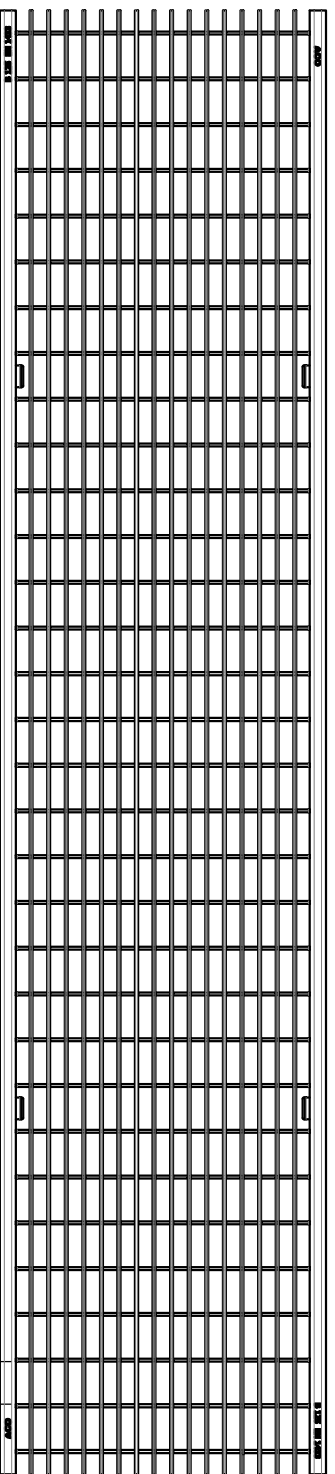
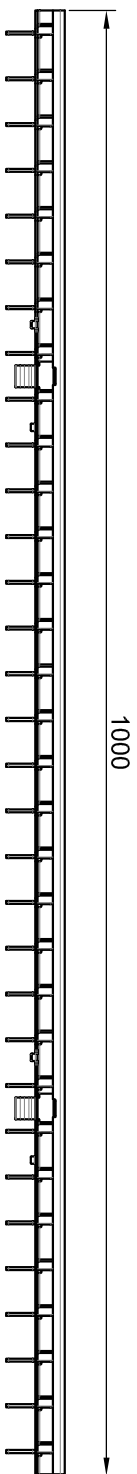

Inloopdoorsnede /
absorption: 1575 cm²/m

Naam - Nom Multiline V 200 Q+ maastrooster uit roestvrij staal kl. B 125 kN (AISI 304, mazen / mailles 30x10 mm) Q+ grille caillaboits en acier inoxydable cl. B 125 kN		Name SB TS	Date 05/01/17 05/01/17		ACO Passavant NV/SA Peenakker 8 B - 1785 Merchtem Tel.: 052/38.17.70 Fax: 052/38.17.71 info@aco.be www.aco.be
Technische veranderingen voorbehouden - Sous réserve de changements techniques		Maten in millimeter			
Dimensions en millimètres		Maten in millimeter			

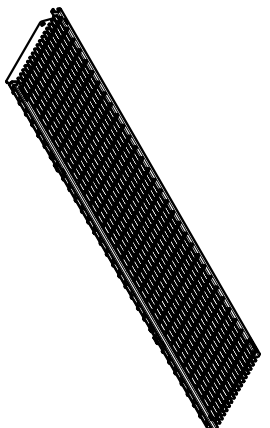
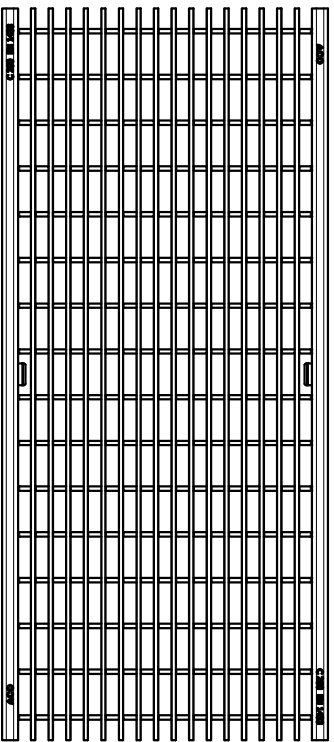
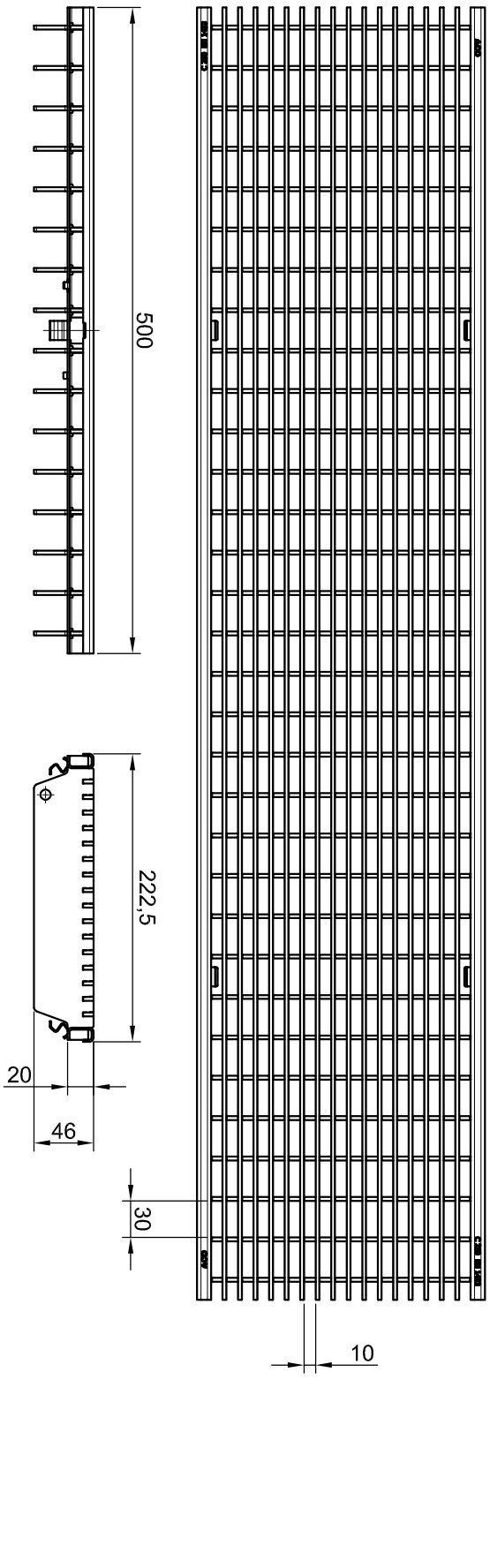
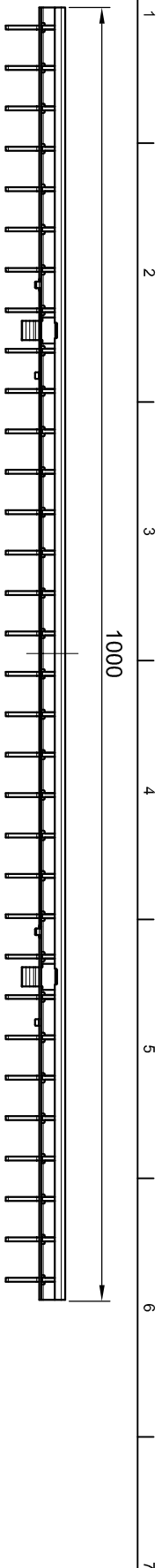

Inloopdoorsnede /
absorption: 1377 cm²/m

Naam - Nom Multiline V 200 Q+ maastrooster uit roestvrij staal kl. C 250 kN (AISI 304, mazen / mailles 30x10 mm) Q+ grille caillaboits en acier inoxydable cl. C 250 kN		Technische veranderingen voorbehouden - Sous réserve de changements techniques	
Maten in millimeter By SB Check TS	Name SB TS	Date 20/09/17 20/09/17	Article-Nr. - N° d'article 133619 (1 m) 133620 (0,5 m)
ACO Passavant NV/SA Peenakker 8 B - 1785 Merchtem Tel.: 052/38.17.70 Fax: 052/38.17.71 info@aco.be www.aco.be		Tekening Nr - Dessin n°	

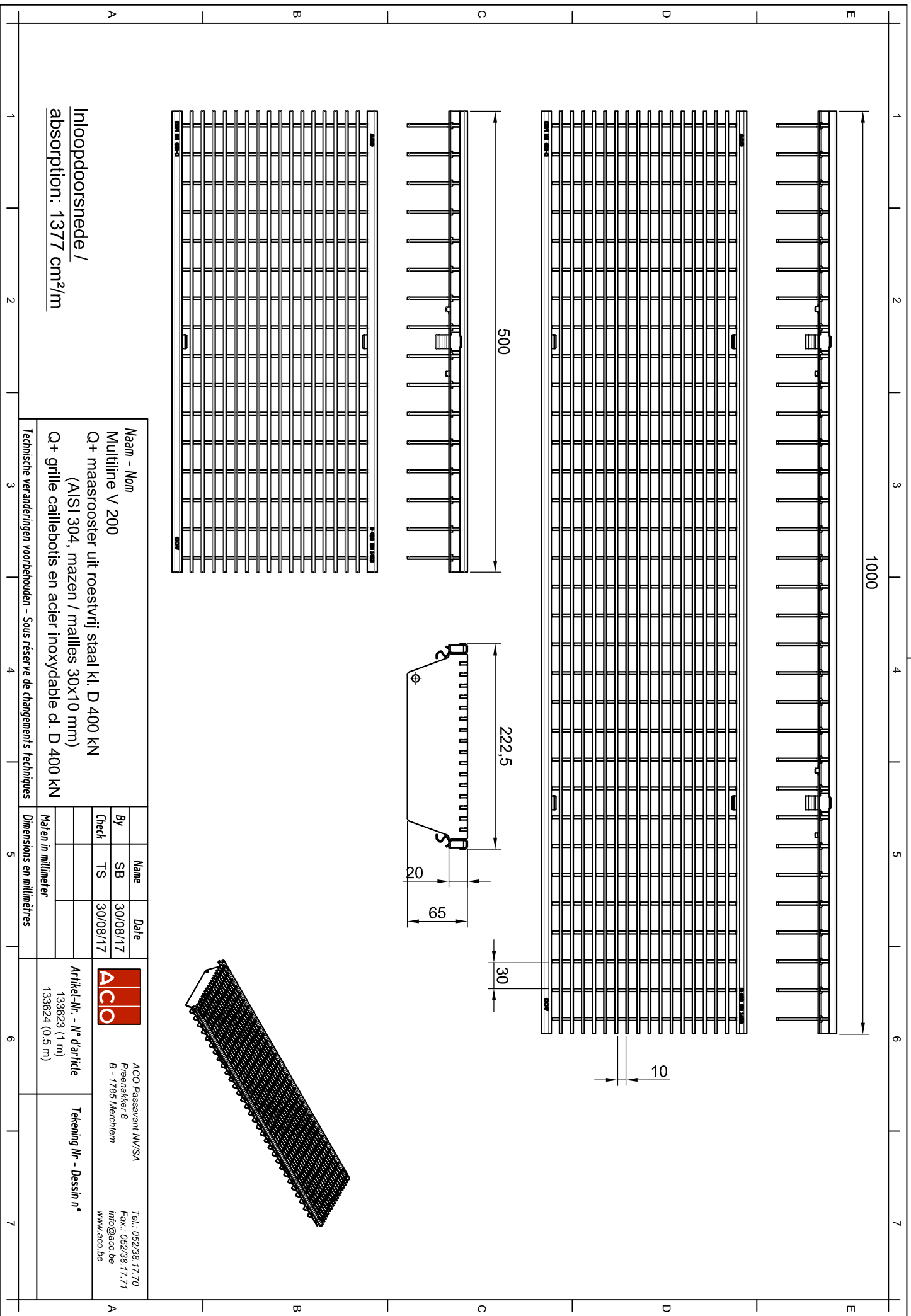

Inloopdoorsnede /
absorption: 1377 cm²/m

Naam - Nom Multiline V 200 Q+ maasrooster uit roestvrij staal Kl. D 400 KN (AISI 304, mazen / mailles 30x10 mm) Q+ grille caillaboits en acier inoxydable cl. D 400 KN		Technische veranderingen voorbehouden - Sous réserve de changements techniques	
Maten in millimeter		Dimensions en millimètres	
By	Name	Date	
Check	SB	30/08/17	
	TS	30/08/17	
Artikel-Nr. - N° d'article 133623 (1 m) 133624 (0,5 m)		Tekening Nr - Dessin n°	
ACO ACO Passavant NV/SA Peenakker 8 B - 1785 Merchtem Tel.: 052/38.17.70 Fax: 052/38.17.71 info@aco.be www.aco.be			

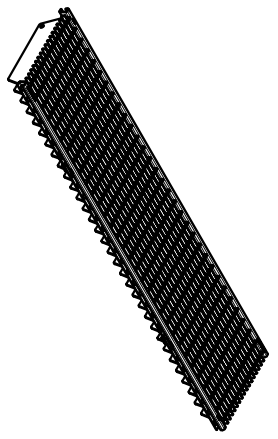

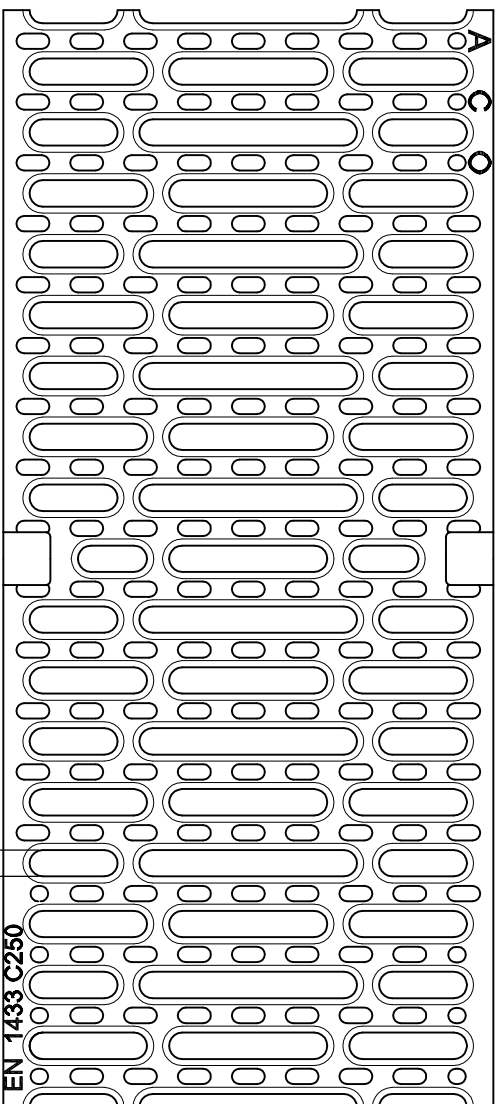
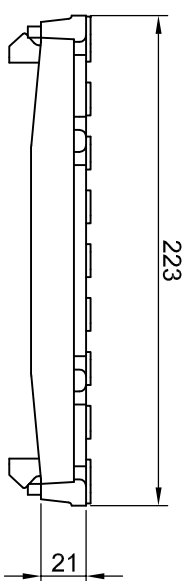
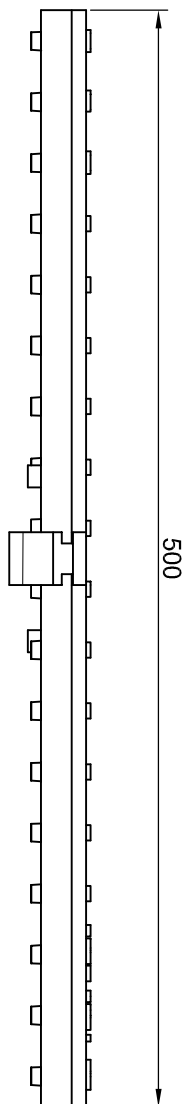

Inloopdoorsnede /
absorption: 740 cm²/m

Naam - Nom
Multiiline V 200
sleufrooster uit gietijzer kl. C 250 KN
grille passerelle en fonte cl. C 250 KN

Name	Date
By SB	18/07/12
Check SW	18/07/12



ACO Passavant NV/SA
Peebakkert 8
B - 1785 Merchtem

Tel.: 052/38.17.70
Fax: 052/38.17.71
info@aco.be
www.aco.be

Maten in millimeter

Artikel-Nr. - N° d'article
13470

Tekening Nr - Dessin n°

Technische veranderingen voorbehouden - Sous réserve de changements techniques

Dimensions en millimètres

Inloopdoornede /
absorptie: 740cm²/m

Multiline V 200
stuurrooster uit gietijzer klasse D 400 kN
grille passerelle en fonte classe D 400 kN

Naam - Nom

Name	Date
By	12/02/18
Check	12/02/18

Maten in millimeter

Dimensions en millimètres	

Artikel-Nr. - N° d'article



ACO Passavant NV/SA

Preenakker 8
B - 1785 Merchtem

Tel.: 052/38.17.70
Fax.: 052/38.17.71
info@aco.be
www.aco.be

Tekening Nr. - Dessin n°

23224

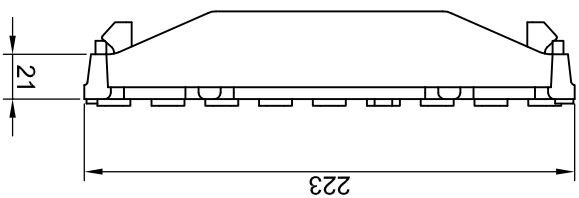
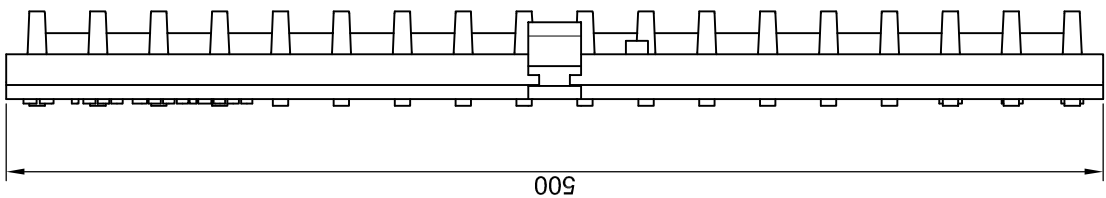
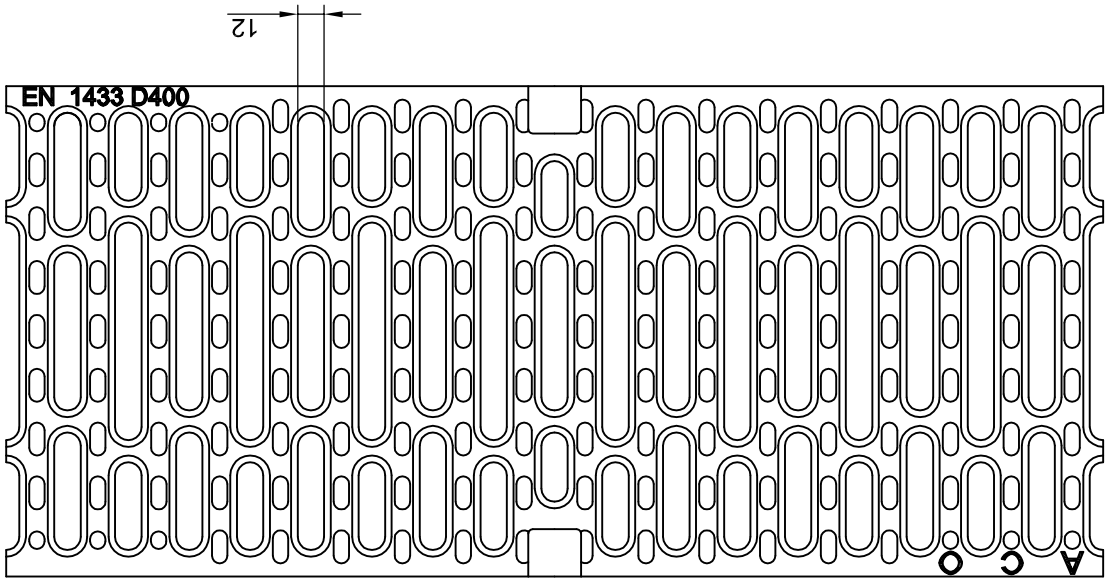

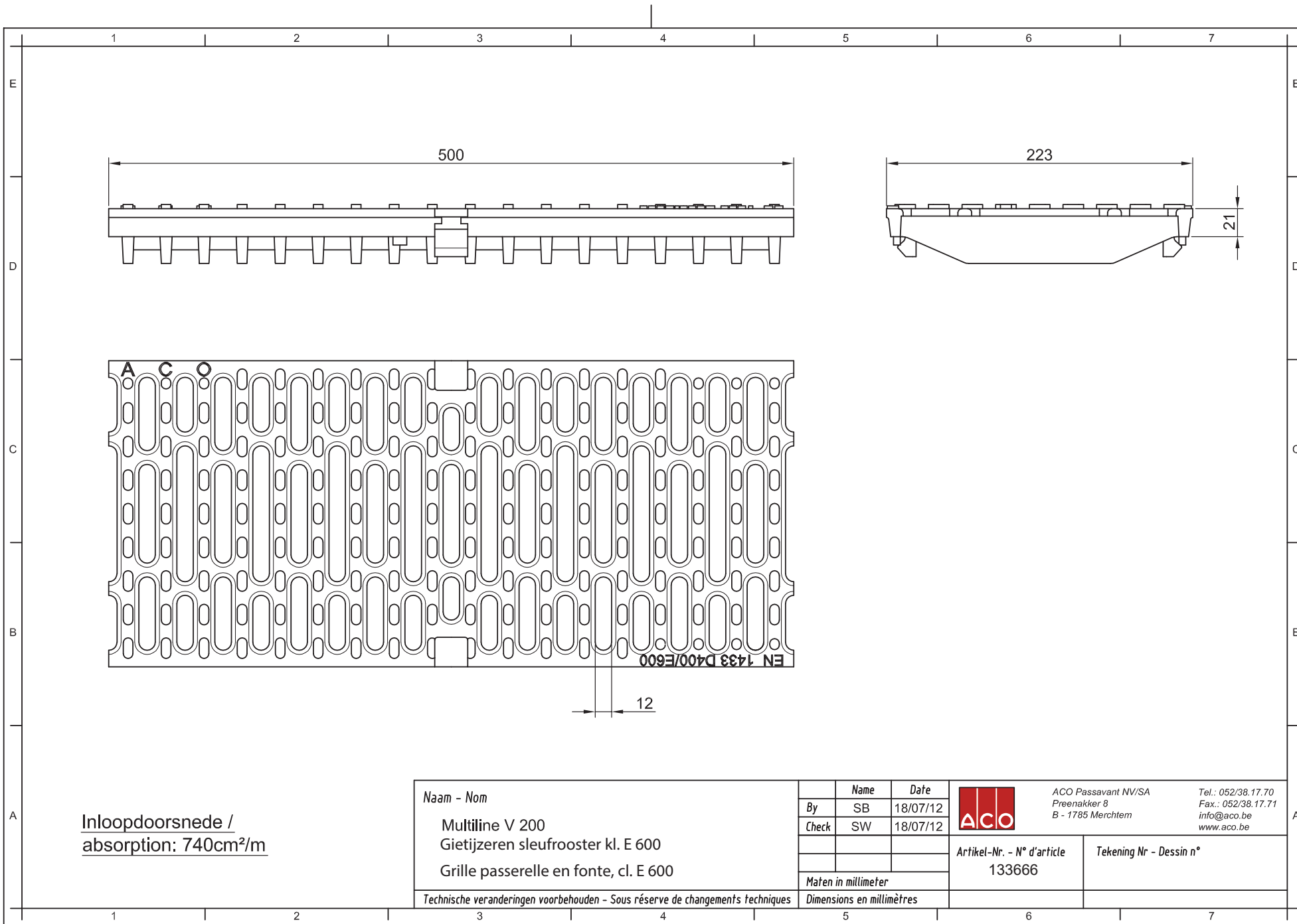

Inloopdoorsnede /
absorption: 740cm²/m

Naam - Nom

Multiline V 200
 Gietijzeren sleufrooster kl. E 600
 Grille passerelle en fonte, cl. E 600

Technische veranderingen voorbehouden - Sous réserve de changements techniques

	Name	Date
By	SB	18/07/12
Check	SW	18/07/12



ACO Passavant NV/SA
 Preenakker 8
 B - 1785 Merchtem

Tel.: 052/38.17.70
 Fax.: 052/38.17.71
 info@aco.be
 www.aco.be

Artikel-Nr. - N° d'article
 133666

Tekening Nr - Dessin n°

Maten in millimeter

Dimensions en millimètres

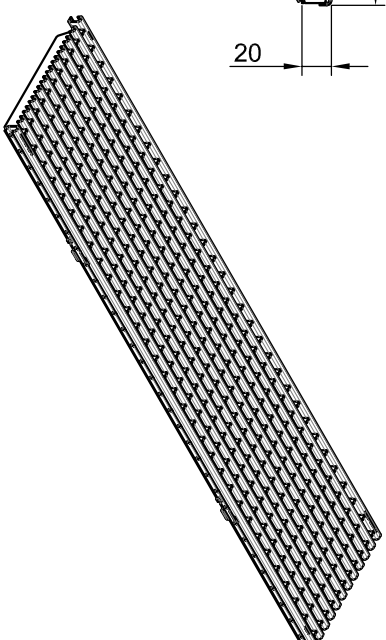
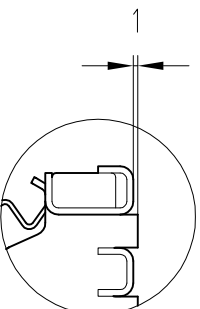
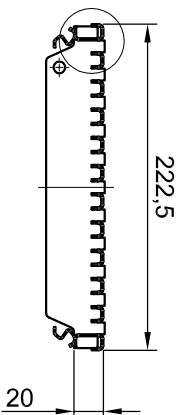
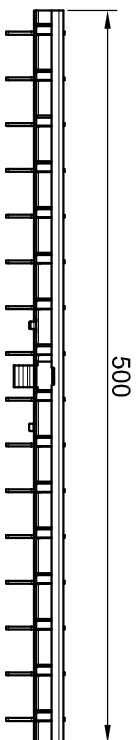
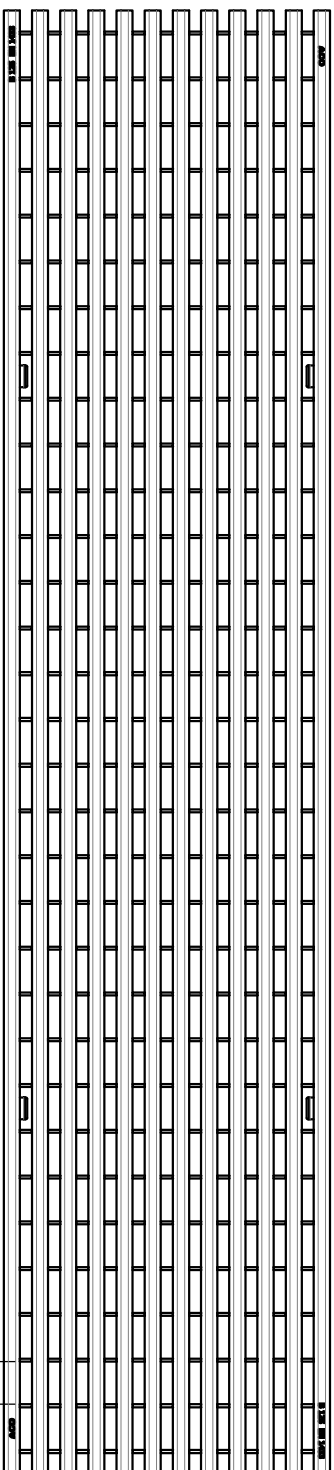
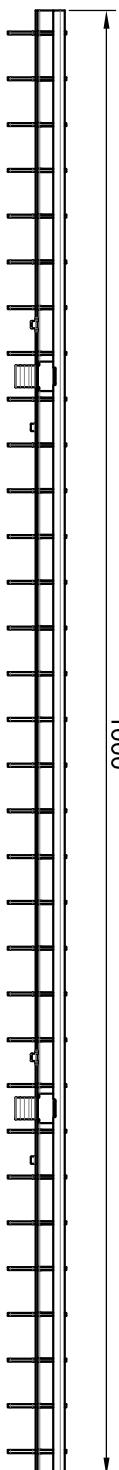

Inloopdoorsnede /
absorption: 846 cm²/m

Naam - Nom
Multiline V 200
lengtestaafrooster uit verzinkt staal
B 125 kN - profiel U profiel 8 mm
grille passerelles longitudinales en acier galvanisé

Technische veranderingen voorbehouden - Sous réserve de changements techniques

Maten in millimeter		Dimensions en millimètres	
By	Name	Date	
SB	SB	05/01/17	
Check	TS	05/01/17	



ACO Passavant NV/SA
Peebikker 8
B - 1785 Merchtem
Tel.: 052/38.17.70
Fax: 052/38.17.71
info@aco.be
www.aco.be

Artikel-Nr. - N° d'article
133629 (1 m)
133630 (0,5 m)

Tekening Nr - Dessin n°

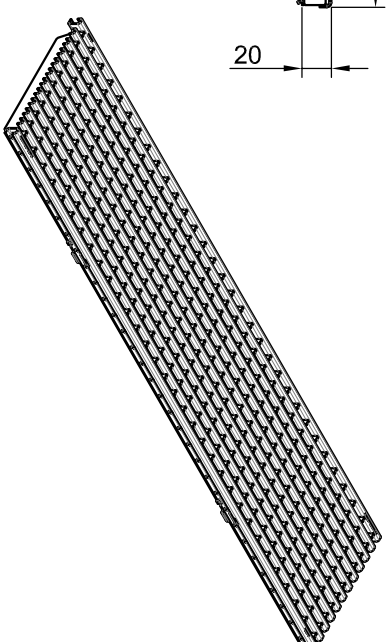
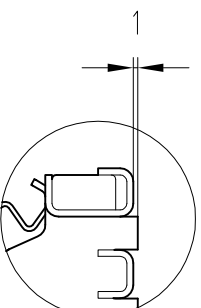
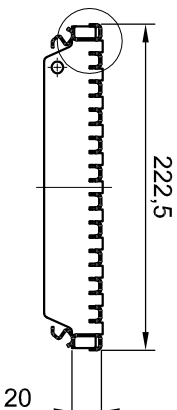
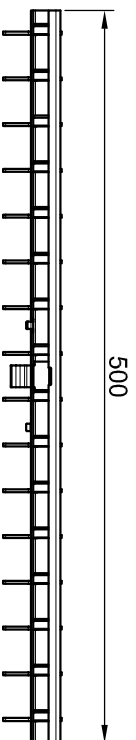
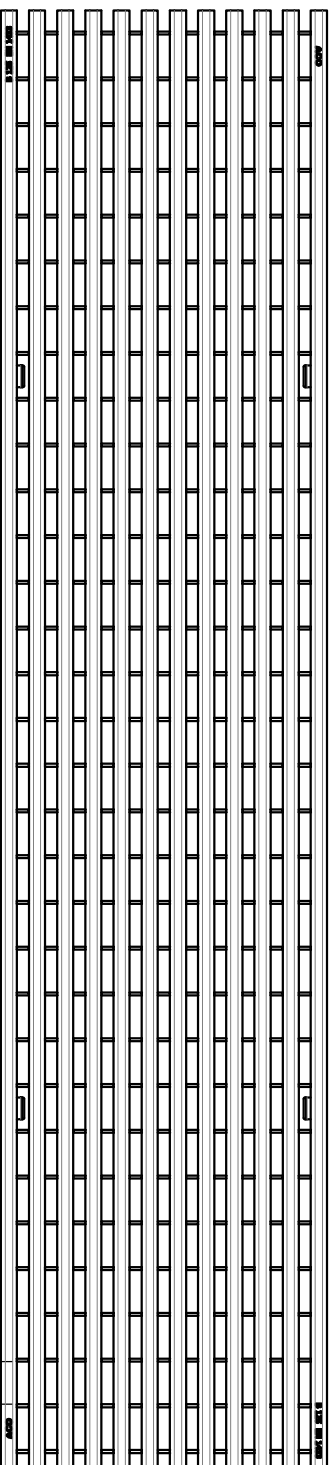
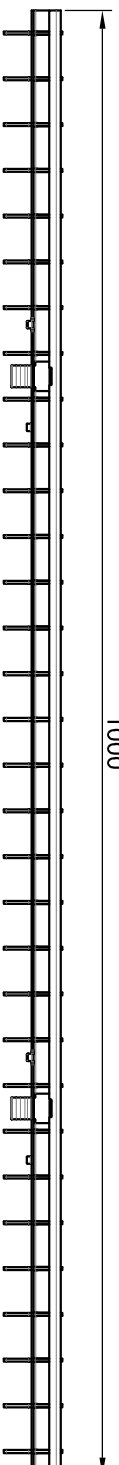

Inloopdoorsnede /
absorption: 846 cm²/m

Naam - Nom
Multiline V 200
lengtestaatrooster uit roestvrij staal
(AISI 304) - B 125 KN - profiel U profiel 8 mm
grille passerelles longitudinales en acier Inoxydable

Technische veranderingen voorbehouden - Sous réserve de changements techniques

Maten in millimeter		Dimensions en millimètres	
By	Name	Date	
SB	SB	05/01/17	
Check	TS	05/01/17	



ACO Passavant NV/SA
Peebikker 8
B - 1785 Merchtem

Tel.: 052/38.17.70
Fax: 052/38.17.71
info@aco.be
www.aco.be

Artikel-Nr. - N° d'article
133631 (1 m)
133632 (0,5 m)

Tekening Nr - Dessin n°

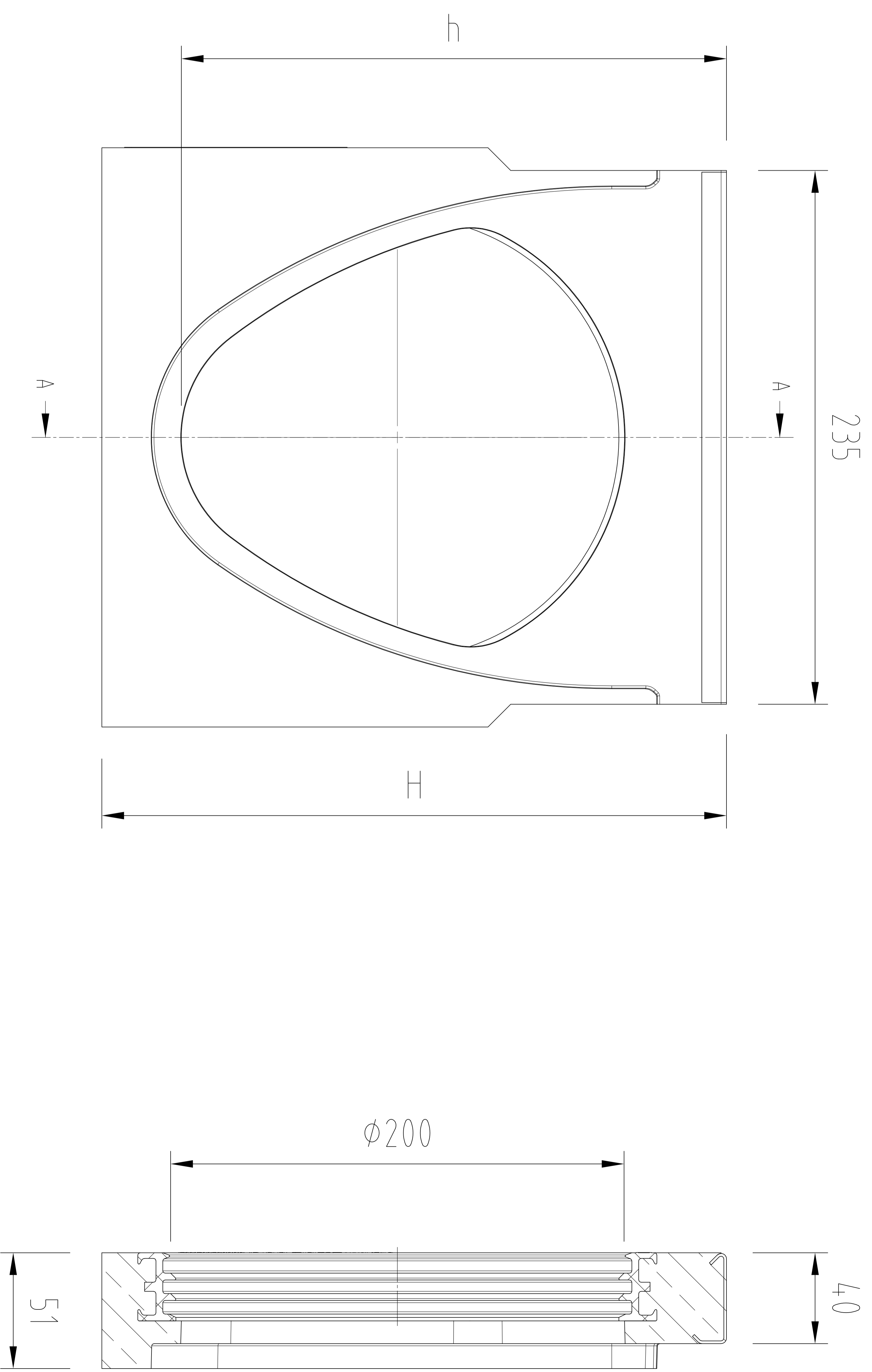
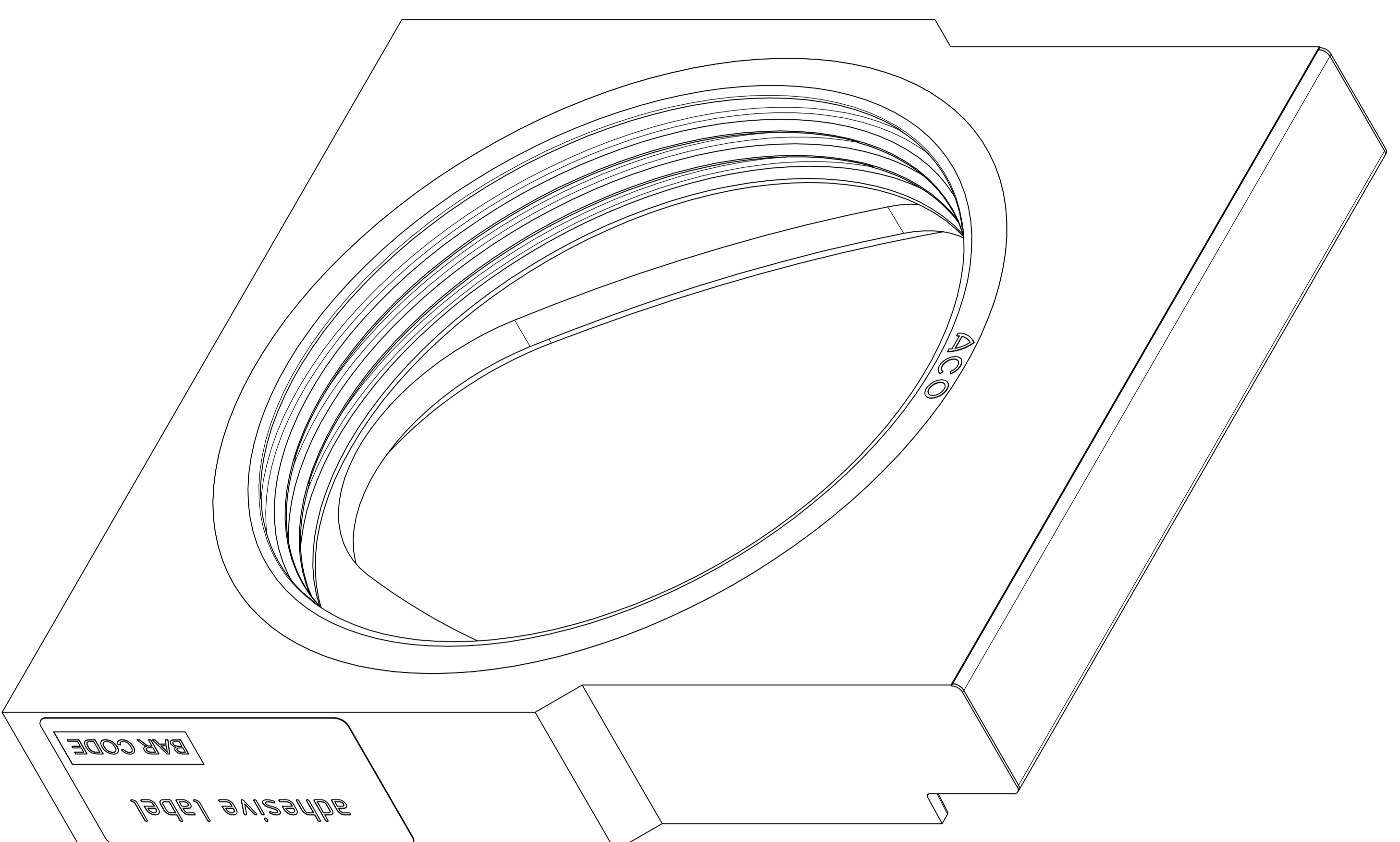

Type	H (mm)	h (mm)	Verzinkt staal Acier galvanisé	Roestvrij staal Acier inoxydable
Type 0.0	275	240	133586	133786
Type 5.0	300	265	133587	133787
Type 10.0	325	290	133588	133788
Type 20.0	375	340	133589	133789

Multiline V 200 S "Seal in" (0.0 - 20.0)
Eindplaat met uitloop
About avec sortie

Technische veranderingen voorbehouden - Sous réserve de changements techniques

Name	Date
By TS	19/11/21
Check	
Maten in millimeter	
Dimensions en millimètres	

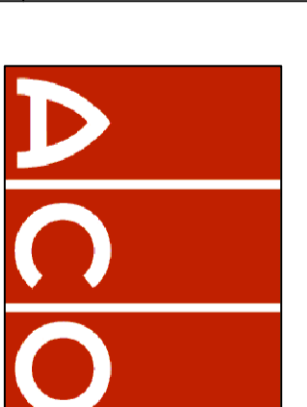

ACO Passavant NV/SA Tel.: 052/38.17.70
 Preenakker 8 Fax.: 052/38.17.71
 B - 1785 Merchtem info@aco.be
 www.aco.be

Artikel-Nr. - N° d'article
 zie tabel / voir tableau

Tekening Nr. - Dessin n°

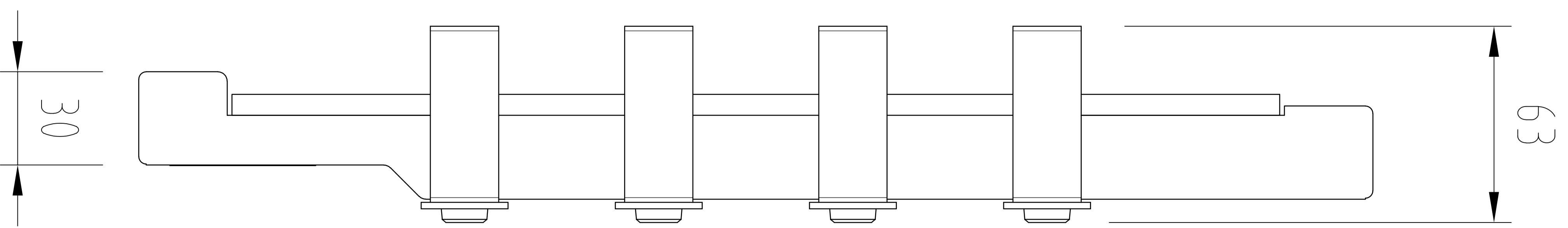
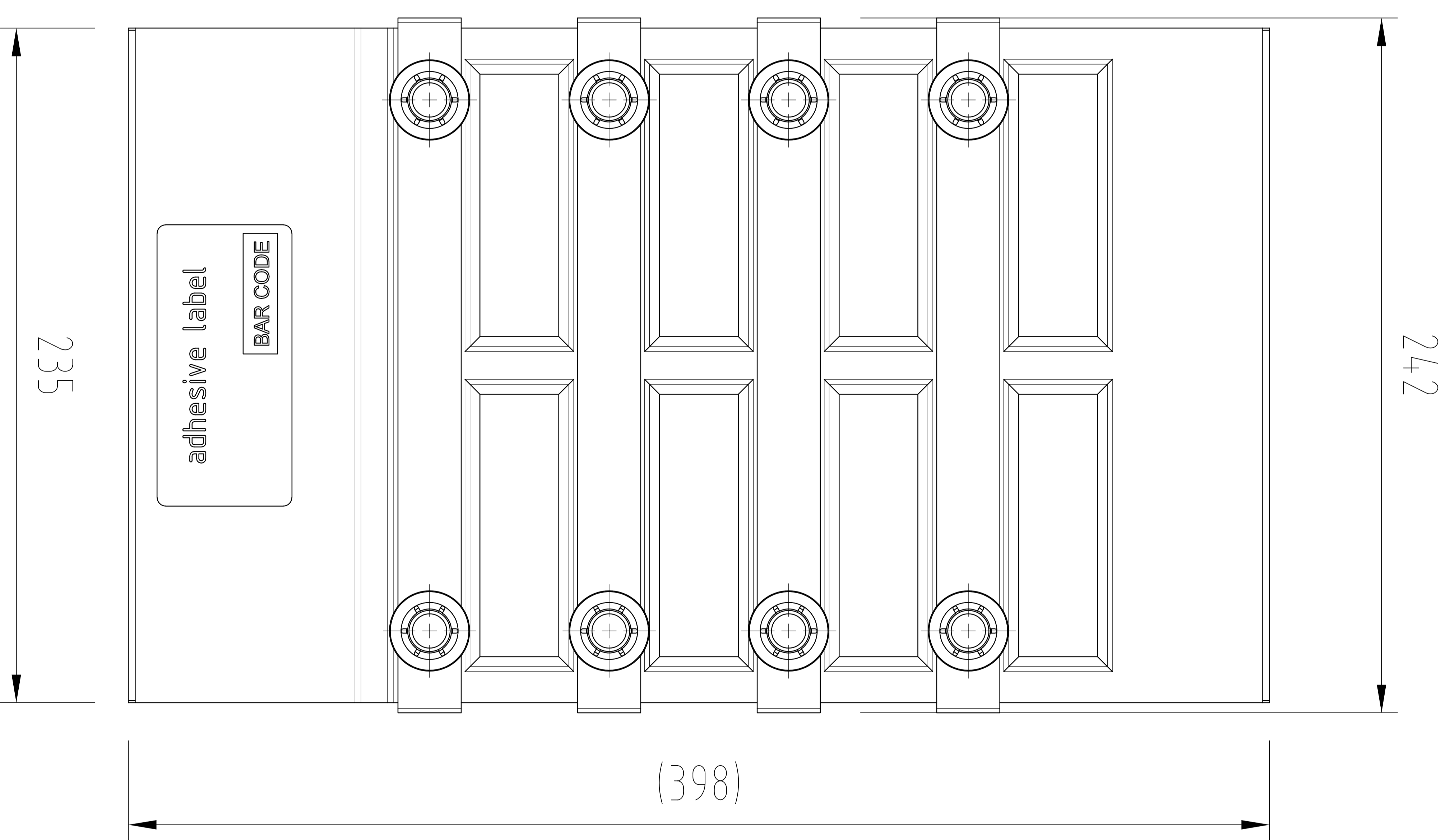
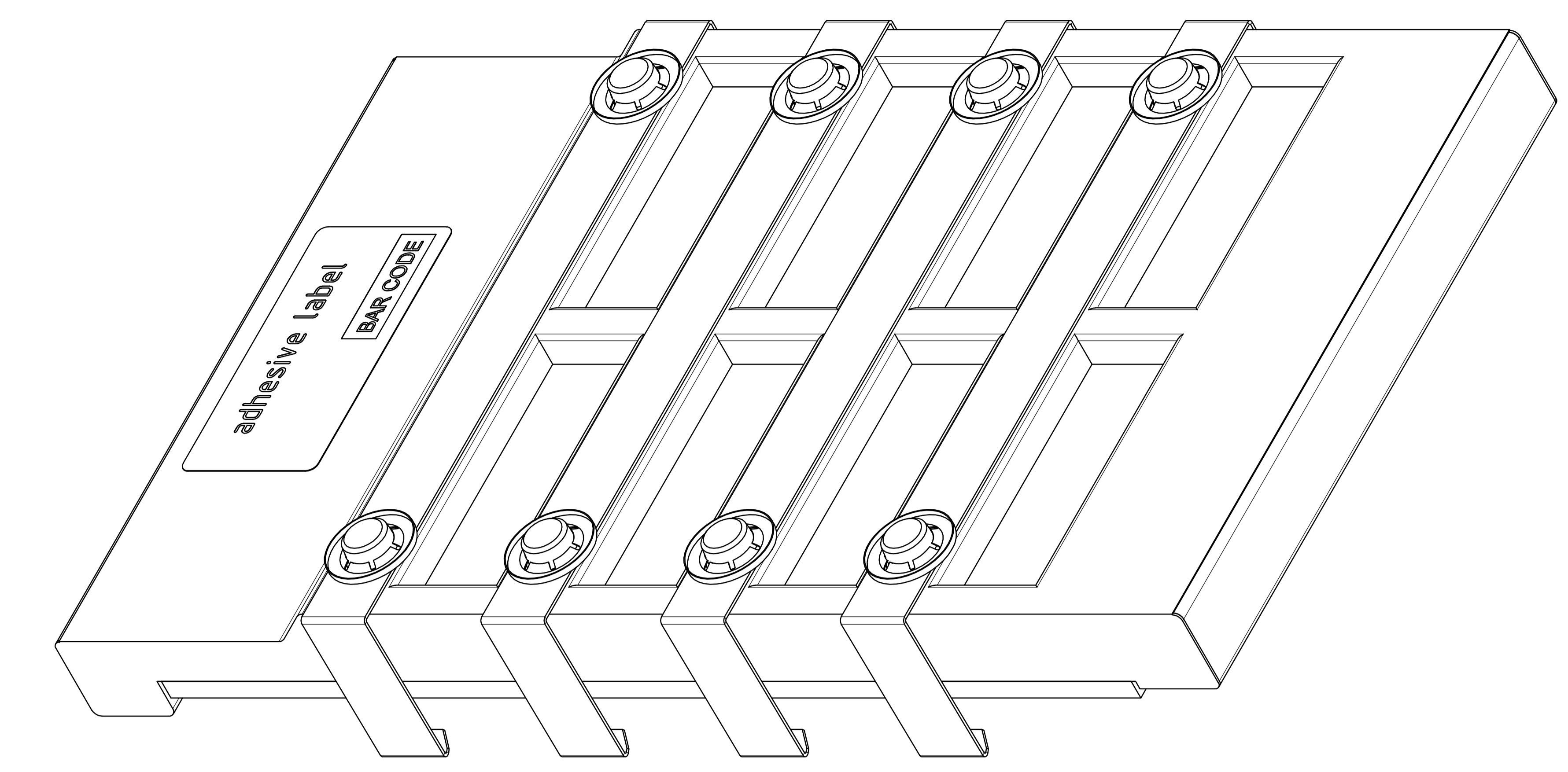

1	2	3	4	5	6	7																											
<table border="1"> <tr> <td>Verzinkt staal Acier galvanisé</td> <td>Roestvrij staal Acier inoxydable</td> </tr> <tr> <td>Art. 133585</td> <td>Art. 133785</td> </tr> </table>		Verzinkt staal Acier galvanisé	Roestvrij staal Acier inoxydable	Art. 133585	Art. 133785	<p>Technische veranderingen voorbehouden - Sous réserve de changements techniques</p>			<table border="1"> <tr> <td colspan="2"> <p>Multiline V 200 S "Seal in" (0.0 - 20.0)</p> <p>Volle eindplaat - About plein</p> </td> </tr> <tr> <td>By</td> <td>Name</td> <td>Date</td> </tr> <tr> <td>TS</td> <td></td> <td>19/11/21</td> </tr> <tr> <td>Check</td> <td></td> <td></td> </tr> <tr> <td colspan="3">Maten in millimeter</td> </tr> <tr> <td colspan="3">Dimensions en millimètres</td> </tr> </table>		<p>Multiline V 200 S "Seal in" (0.0 - 20.0)</p> <p>Volle eindplaat - About plein</p>		By	Name	Date	TS		19/11/21	Check			Maten in millimeter			Dimensions en millimètres			<table border="1"> <tr> <td rowspan="2"> <p>Artikel-Nr. - N° d'article</p> <p>zie tabel / voir tableau</p> </td> <td rowspan="2"> <p>Tekening Nr. - Dessin n°</p> </td> </tr> <tr> <td colspan="2"> <p>ACO</p> <p>ACO Passavant NV/SA Tel.: 052/38.17.70 Preenakker 8 Fax.: 052/38.17.71 B - 1785 Merchtem info@aco.be www.aco.be</p> </td> </tr> </table>		<p>Artikel-Nr. - N° d'article</p> <p>zie tabel / voir tableau</p>	<p>Tekening Nr. - Dessin n°</p>	<p>ACO</p> <p>ACO Passavant NV/SA Tel.: 052/38.17.70 Preenakker 8 Fax.: 052/38.17.71 B - 1785 Merchtem info@aco.be www.aco.be</p>	
Verzinkt staal Acier galvanisé	Roestvrij staal Acier inoxydable																																
Art. 133585	Art. 133785																																
<p>Multiline V 200 S "Seal in" (0.0 - 20.0)</p> <p>Volle eindplaat - About plein</p>																																	
By	Name	Date																															
TS		19/11/21																															
Check																																	
Maten in millimeter																																	
Dimensions en millimètres																																	
<p>Artikel-Nr. - N° d'article</p> <p>zie tabel / voir tableau</p>	<p>Tekening Nr. - Dessin n°</p>																																
		<p>ACO</p> <p>ACO Passavant NV/SA Tel.: 052/38.17.70 Preenakker 8 Fax.: 052/38.17.71 B - 1785 Merchtem info@aco.be www.aco.be</p>																															
A	B	C	D	E	A	B																											

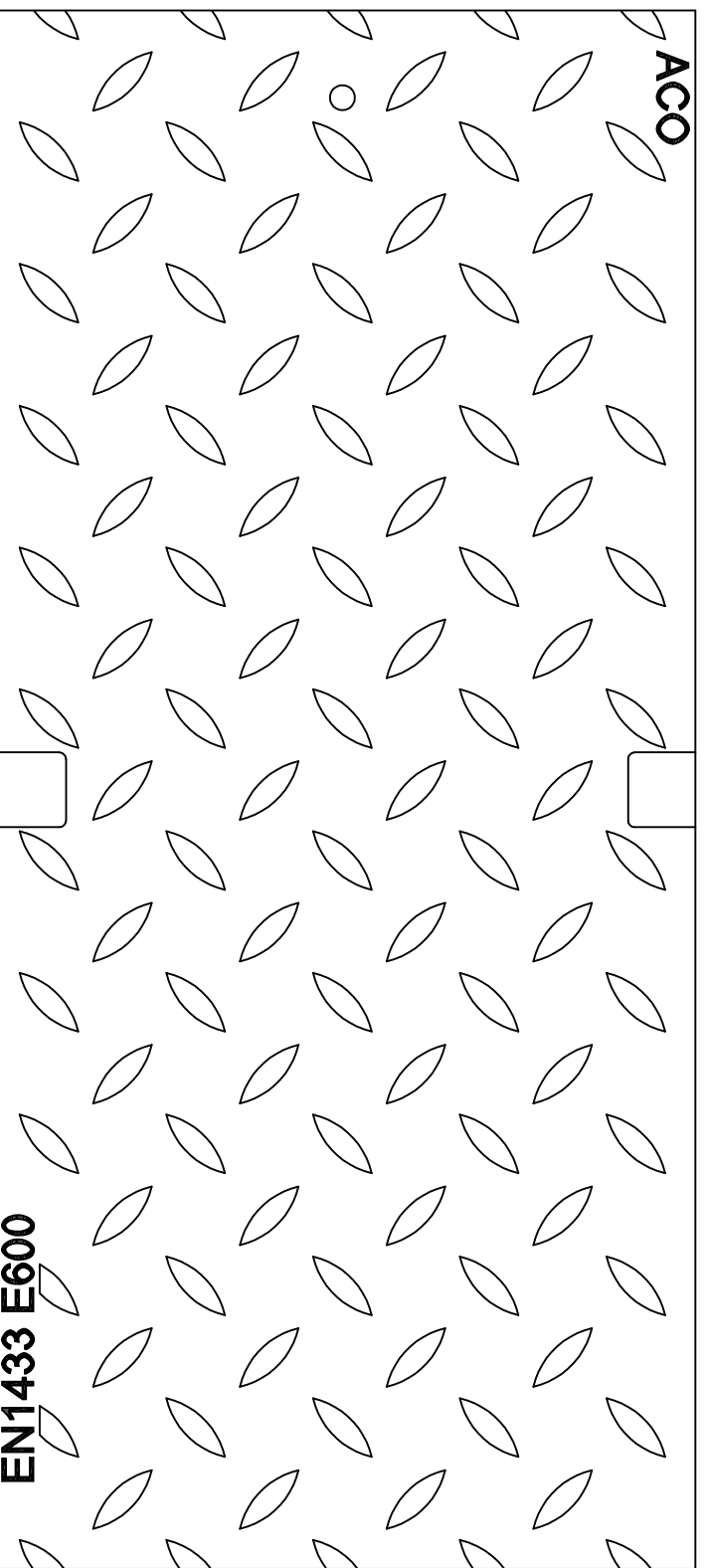
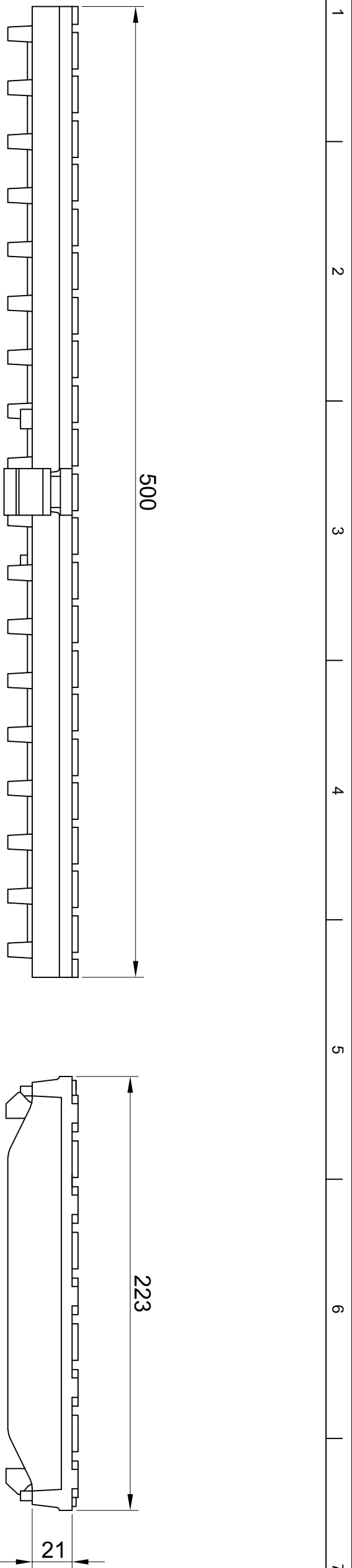

Naam - Nom Multiline V 200 afdekplaat uit gietijzer kl. D 400 / E 600 KN tôle larmée en fonte cl. D 400 / E 600 KN		Name TS 21/09/20		Date 21/09/20		 ACO Passavant NV/SA Preenakker 8 B - 1785 Merchiem Tel.: 052/38.17.70 Fax.: 052/38.17.71 info@aco.be www.aco.be	Artikel-Nr. - N° d'article 133670	Tekenings Nr. - Dessin n°
Technische veranderingen voorbehouden - Sous réserve de changements techniques		By Check		Maten in millimeter Dimensions en millimètres				

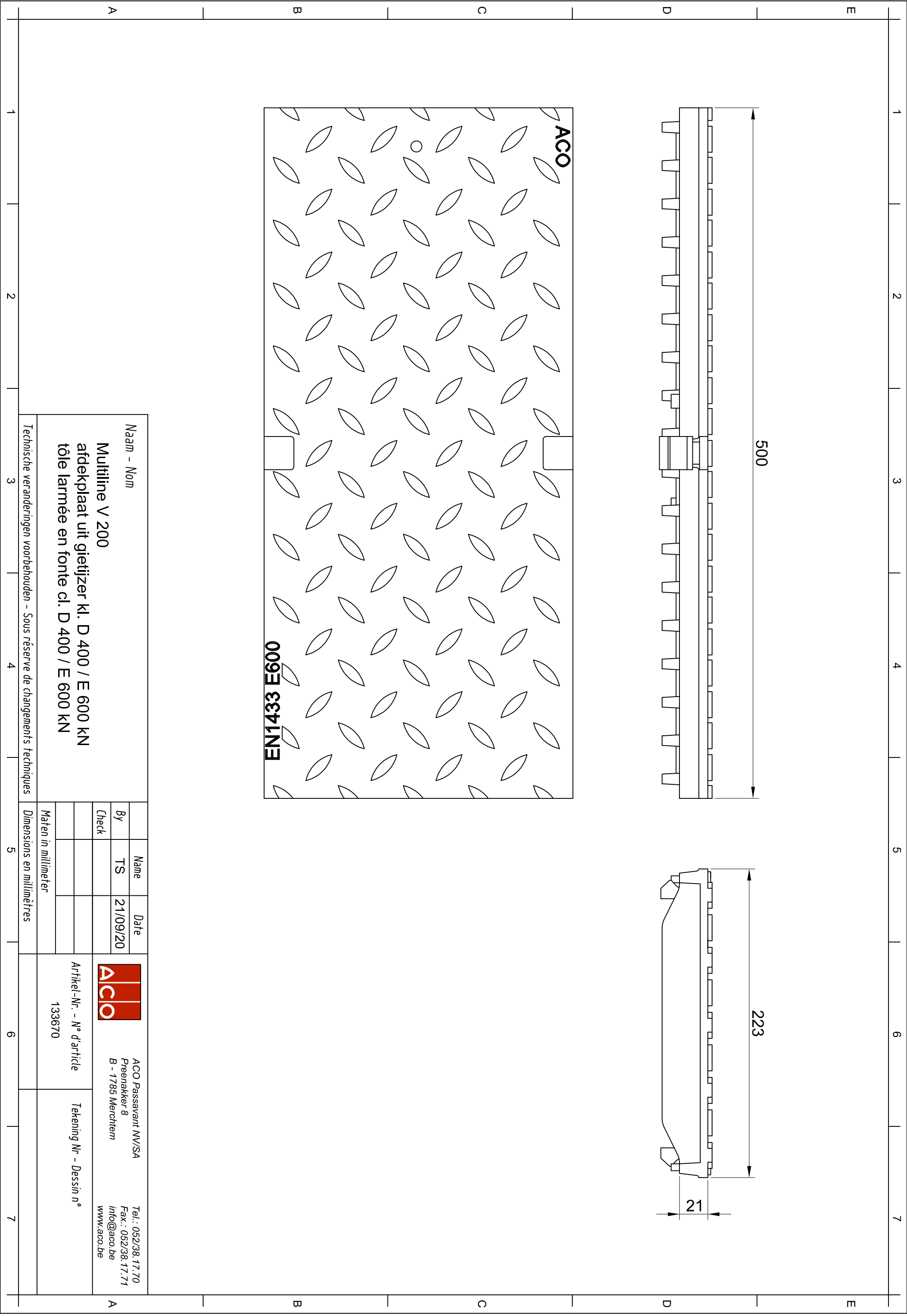

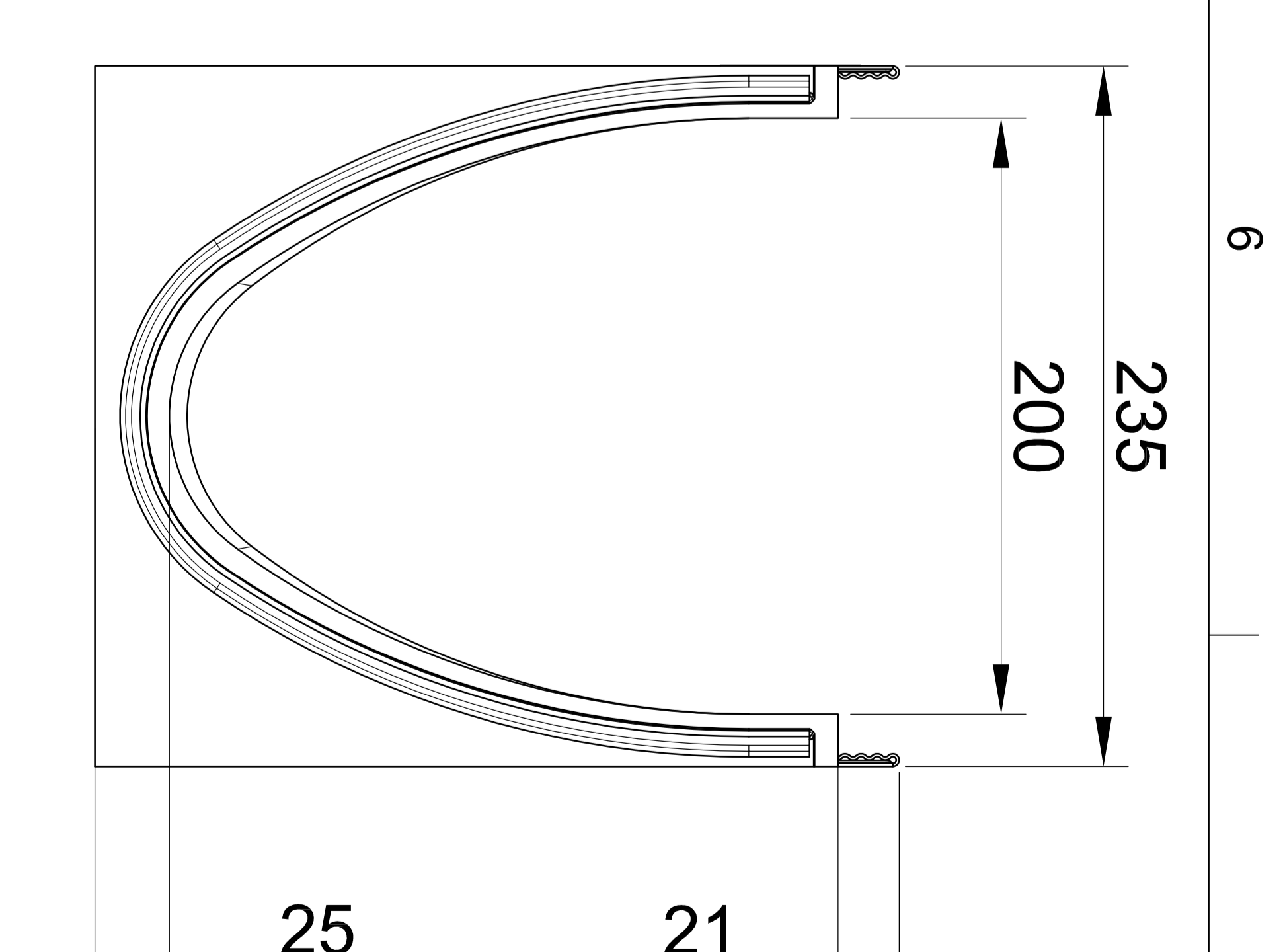
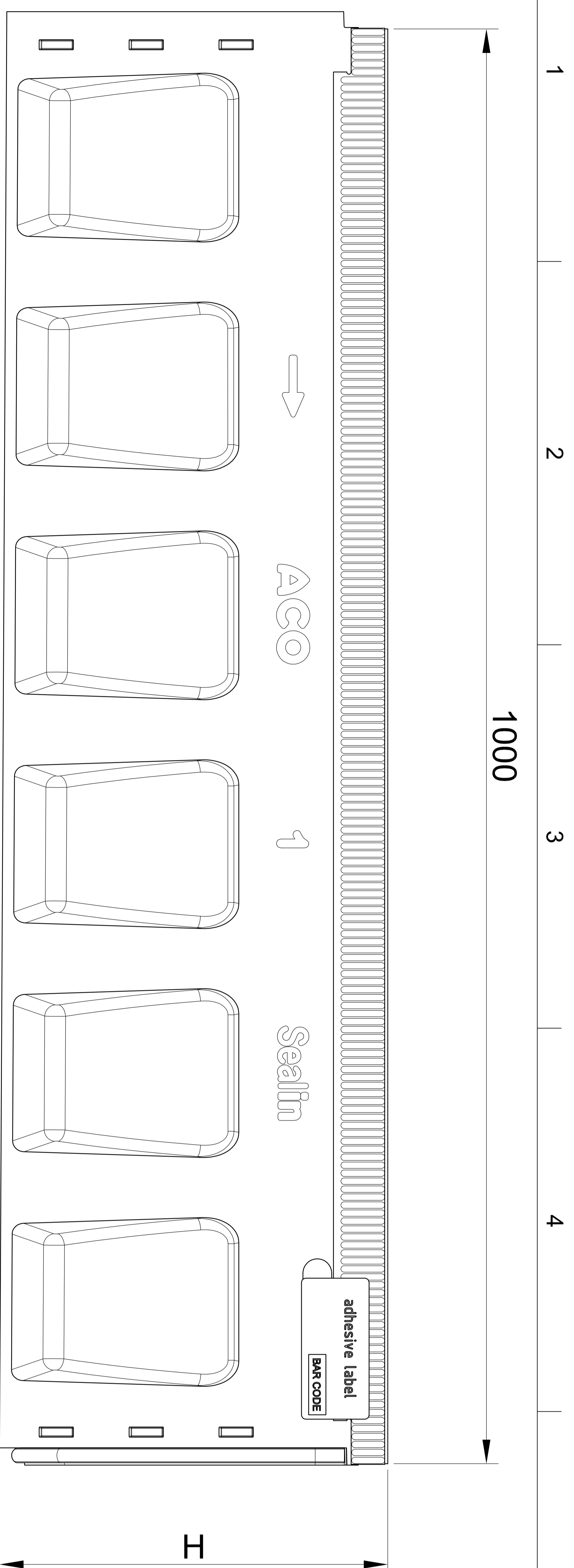

Type	H1 (mm)	H2 (mm)	Randbescherming uit / Feuilleure en	
			Verzinkt staal / acier galvanisé	Roestvrij staal / acier inoxydable
1	265	270	133501	133701
2	270	275	133502	133702
3	275	280	133503	133703
4	280	285	133504	133704
5	285	290	133505	133705
6	290	295	133506	133706
7	295	300	133507	133707
8	300	305	133508	133708
9	305	310	133509	133709
10	310	315	133510	133710

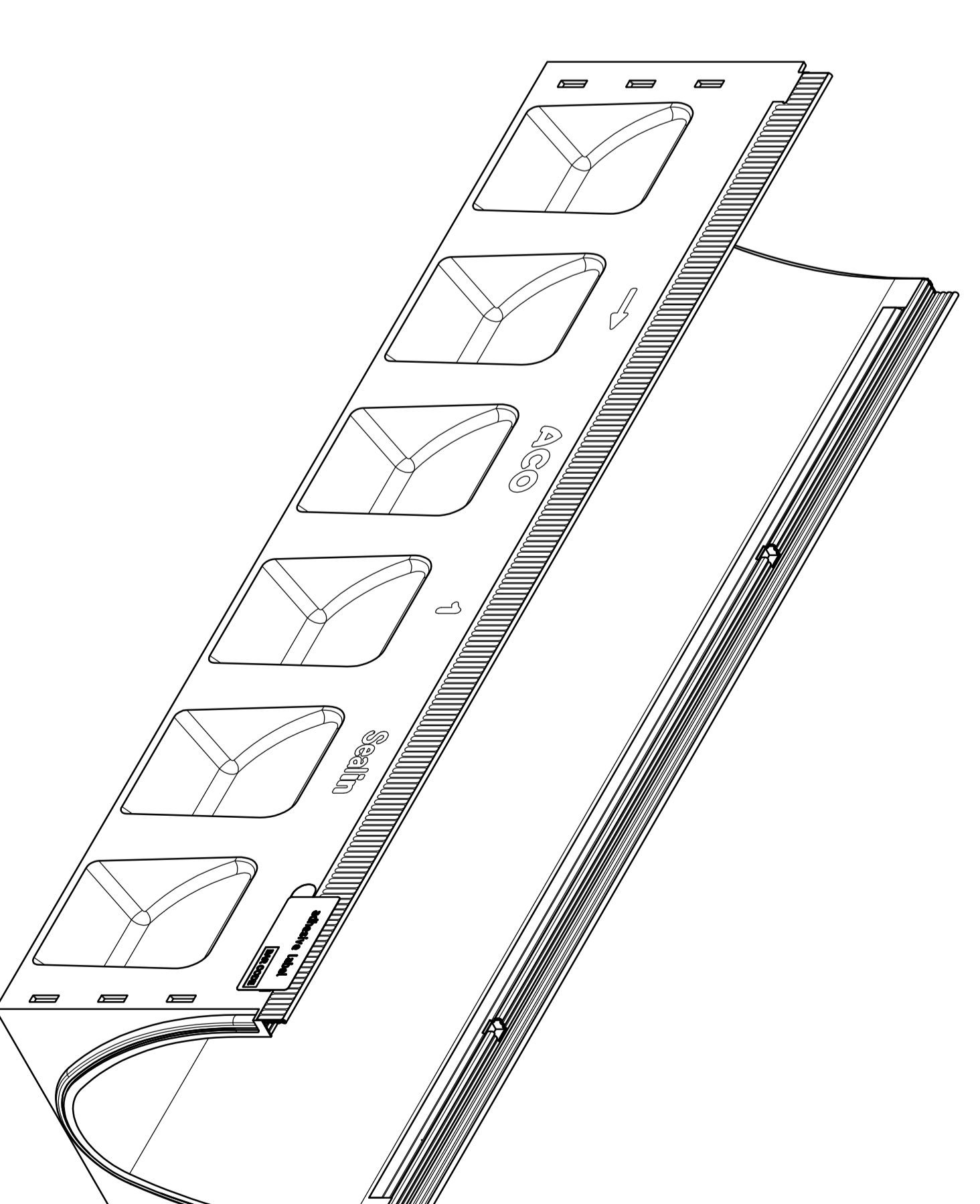

Multiline V 200 S "Seal in" (helling - pente)
 met geïntegreerde EPDM-afdichting thv tand/groef
 avec joint EPDM incorporé à la connexion mâle/fem.
belastingsklasse A15 - E600 classe de résistance

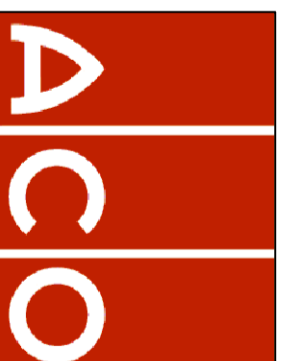
Name	Date	 ACO Passavant NV/SA Preenakker 8 B - 1785 Merchem Tel.: 052/38.17.70 Fax.: 052/38.17.71 info@aco.be www.aco.be
By	SB	
Check	TS	25/03/19
Artikel-Nr. - N° d'article zie tabel / voir tableau		Tekening Nr. - Dessin n°

Technische veranderingen voorbehouden - Sous réserve de changements techniques

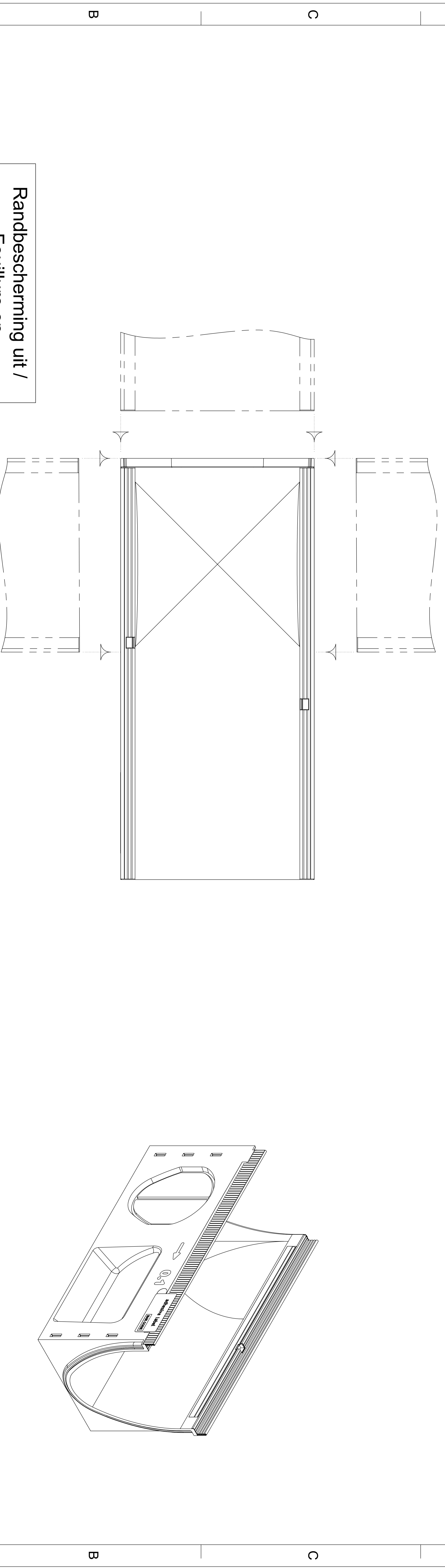
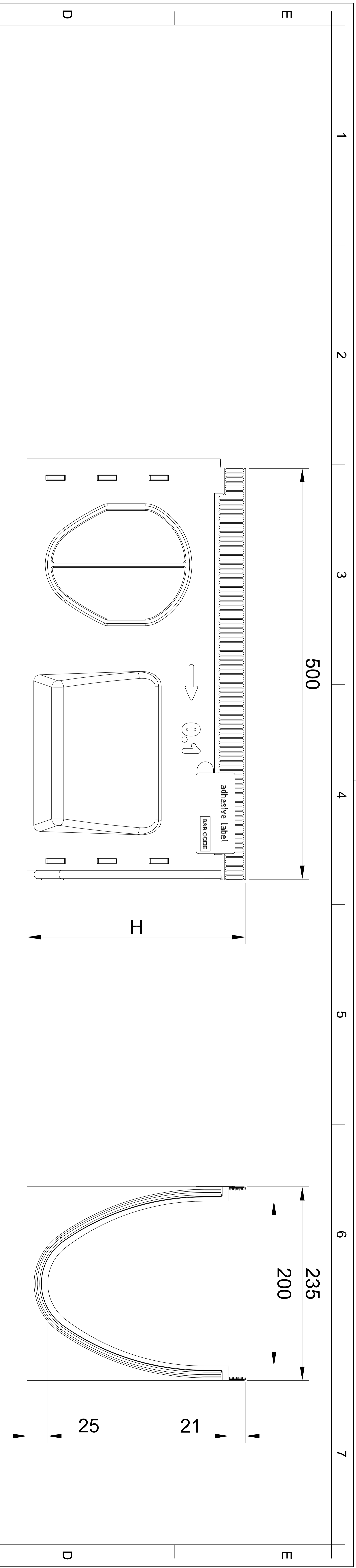

**Randbescherming uit /
Feuilleure en**

Type	H (mm)	Verzinkt st./ Acier galva.	Roestvrij st./ Acier inox.
0.1	265	133531	133731
5.1	290	133541	133741
10.1	315	133551	133751
20.1	365	133571	133771

Multiline V 200 S "Seal in" (0.1 - 20.1)
 met geïntegreerde EPDM-afdichting thv tand/groef
 avec joint EPDM incorporé à la connexion mâle/fem.
belastingsklasse A15 - E600 classe de résistance

Technische veranderingen voorbehouden - Sous réserve de changements techniques

Name	Date
SB	25/03/19
TS	25/03/19

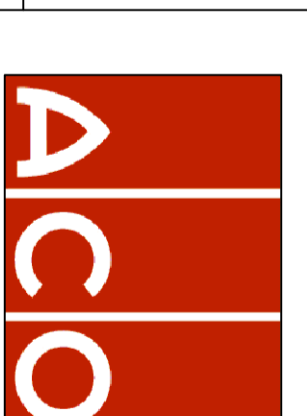

ACO Passavant NV/SA Tel.: 052/38.17.70
 Preenakker 8 Fax.: 052/38.17.71
 B - 1785 Merchtem info@aco.be
 www.aco.be

Artikel-Nr. - N° d'article
 zie tabel / voir tableau

Tekening Nr. - Dessin n°

Maten in millimeter
 Dimensions en millimètres

1 2 3 4 5 6 7

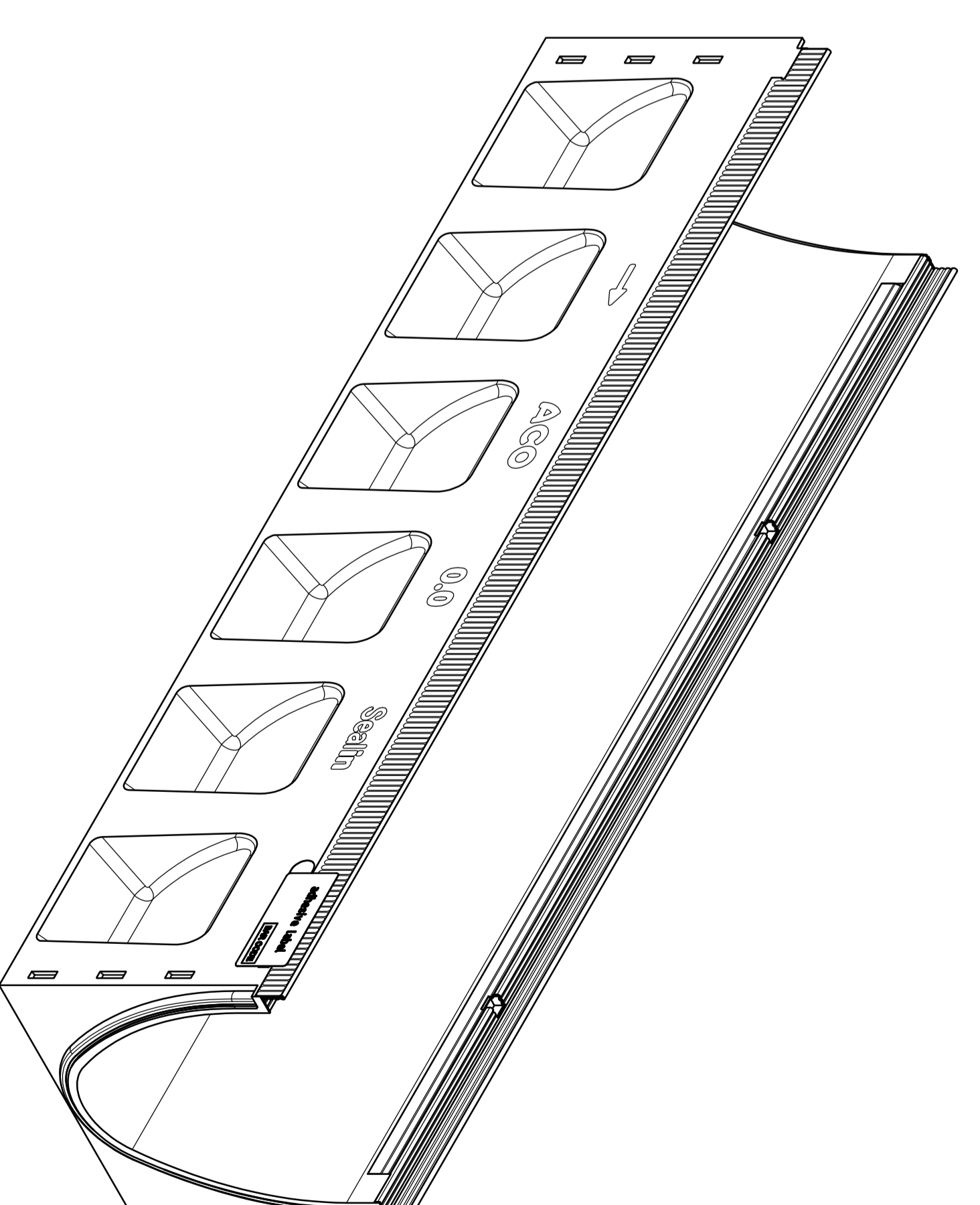
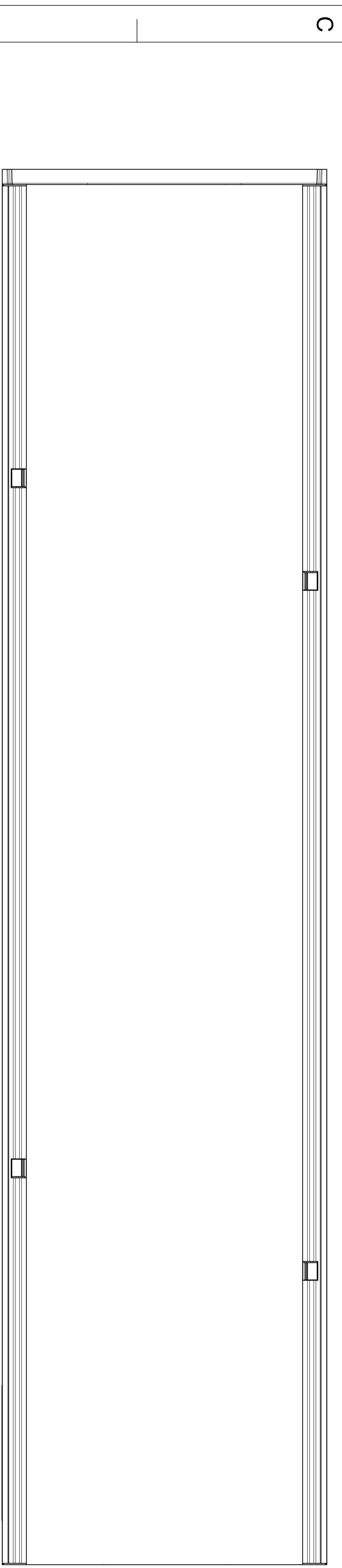
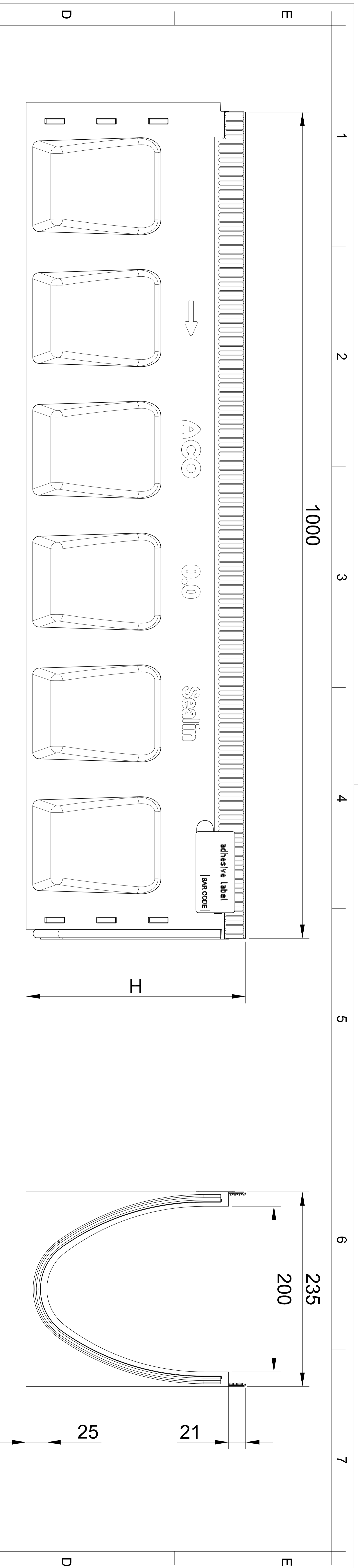

**Randbescherming uit /
Feuillure en**

Type	H (mm)	Verzinkt st./ Acier galva.	Roestvrij st./ Acier inox.
0.0	265	133530	133730
5.0	290	133540	133740
10.0	315	133550	133750
20.0	365	133570	133770

Multiline V 200 S "Seal in" (0.0 - 20.0)
 met geïntegreerde EPDM-afdichting thv tand/groef
 avec joint EPDM incorporé à la connexion mâle/fem.
belastingsklasse A15 - E600 classe de résistance

Name	Date
By SB	25/03/19
Check TS	25/03/19

ACO
 ACO Passavant NV/SA
 Preenakker 8
 B - 1785 Merchtem
 Tel.: 052/38.17.70
 Fax.: 052/38.17.71
 info@aco.be
 www.aco.be

1 2 3 4 5 6 7

Technische veranderingen voorbehouden - Sous réserve de changements techniques

Maten in millimeter
 Dimensions en millimètres

Artikel-Nr. - N° d'article
 zie tabel / voir tableau

Tekening Nr. - Dessin n°